

FUZZYSCAN BARCODE IMAGER

Programming Manual

International Edition, Rev. E2



cino

Revision History

Rev. No.	Released Date	Description
Rev.B Beta	Apr. 16, 2009	❖ First Release
Rev.B0	May 05, 2009	❖ Modify " Symbology Reading Control " - "Code 128/EAN-128 Setting" and " GS1 DataBar Setting" ❖ Add " Appendix " - "Symbology ID Table".
Rev.B1	June 22, 2009	❖ Add " Operation Control " - "Presentation Scanning Mode".(Rename to "Presentation Control" on Rev.B4) ❖ Add " Operation Control " – "Time Delay to Low Power Mode".
Rev.B2	Aug. 21, 2009	❖ Add " Symbology Reading Control " - "Composite Code Setting", "PDF/Micro PDF417 Setting", "Codablock F Setting", Korea Post Code Setting". ❖ Add " Operation Control " – "SmartStand Power Off Timeout". ❖ Add " Condensed DataWizard " - "PDF417/Micro PDF417", "Codablock F", "Korea Post Code" ❖ Modify " Appendix " – " Symbology ID Table"
Rev.B3	Oct. 16, 2009	❖ Add "Host Interface Selection " - "IBM PS/2, 25-30 series keyboard wedge interface". ❖ Add " Operation Control " - "Presentation Scanning Auto-sense". ❖ Add " Appendix " – " Symbology ID Table" – "Code 128"
Rev.B4	Mar. 05, 2010	❖ Modify " Symbology Reading Control " - "UPC-A & UPC-E Setting" ❖ Rename " Serial Interface Control " – "Time Out Control" to "Serial Response Time-out". ❖ Rename " Operation Control " – "Presentation Scanning Mode" to "Presentation Control" ❖ Rename " Operation Control " – "Auto Power Off Duration" to "Light Source On Time". ❖ Rename " Operation Control " – " Presentation Scanning Auto-sense" to "Presentation Auto-sense" ❖ Modify " Operation Control " - "Good Read Duration" ❖ Add " Operation Control " - " Presentation Sensitivity" ❖ Add " Appendix " – "Master Default" System Command
Rev. B5	Apr.12, 2010	❖ Modify " Operation Control " - " Hands Free Time-out"
Rev. B6	May 27, 2010	❖ Modify " Serial Interface Control " – " Baud Rate"
Rev. B7	Jun 25 , 2010	❖ Modify " Symbology Reading Control " - "UPC-A & UPC-E Setting" ❖ Modify " Operation Control " - "Time Delay to Low Power Mode"

Revision History

Rev. No.	Released Date	Description
Rev. B8	Sep 29 , 2010	<ul style="list-style-type: none"> ❖ Modify “Symbology Reading Control” - “UPC-A & UPC-E Setting” and “EAN Setting” ❖ Modify “Keyboard Interface Control” – “Keyboard Layout (Language) Setting” ❖ Add “Operation Control” - “Scan Rate Control” and “Good Read Indicator”
Rev. B9	Nov 10 , 2010	<ul style="list-style-type: none"> ❖ Modify “Serial Interface Control” – “ Baud Rate”
Rev. C1	Mar 04, 2011	<ul style="list-style-type: none"> ❖ Modify “Serial Interface Control” – “ Baud Rate”
Rev. C2	Mar 22, 2011	<ul style="list-style-type: none"> ❖ Modify “Symbology Reading Control” - “Code 39 Setting” ❖ Modify “Serial Interface Control” – “Protocol, ACK/NAK Setting”
Rev. C3	Jul 22, 2011	<ul style="list-style-type: none"> ❖ Rename “ Symbology Reading Control” - “ UCC/EAN-128” to “GS1-128” ❖ Rename “Serial Interface Control” – “ ACK/NAK Transmission Indication” to “ACK Indication” ❖ Modify “Serial Interface Control” – “ACK Indication” and “Serial response time -out”. ❖ Rename “Condensed DataWizard” - “ UCC/EAN-128” to “GS1-128”
Rev. C4	Nov 04, 2011	<ul style="list-style-type: none"> ❖ Modify “Symbology Reading Control” - “ Codabar/ NW-7 Setting ”
Rev. C5	Jan 02, 2012	<ul style="list-style-type: none"> ❖ Modify “ Wand/Laser Emulation Control” – “ Code 39/Code 128 Emulation”
Rev. C6	Mar 05, 2012	<ul style="list-style-type: none"> ❖ Add “Operation Control” - "1D Barcode Forward-reading Indication", "1D Barcode Backward-reading Indication", and "1D Barcode Direction Indication Transmission".
Rev. C7	Jul 25, 2012	<ul style="list-style-type: none"> ❖ Add “Host Interface Selection” – “ USB HID Legacy” ❖ Modify “Symbology Reading Control” - “Code 128 Setting” ❖ Modify “ Wand/Laser Emulation Control” – “ Code 39/Code 128 Emulation” ❖ Modify “Operation Control” - "Operation Mode Setting", “Presentation Control” ❖ Add “Operation Control” - " LED illumination Control” and “LED Illumination Delay”
Rev. D1	Dec. 18, 2012	<ul style="list-style-type: none"> ❖ Support 2D Functions.
Rev. D2	Apr. 22. 2013	<ul style="list-style-type: none"> ❖ Modify “Symbology Reading Control” - “ Data Matrix Setting ❖ Modify “Operation Control” - “Batch Reading rule example”
Rev. D3	Aug. 20, 2013	<ul style="list-style-type: none"> ❖ Modify “Symbology Reading Control” - “Readable Bar Code Setting” ❖ Modify “Appendix” - “Symbology ID Table”

Revision History

Rev. No.	Released Date	Description
Rev. D4	Sep. 06, 2013	❖ Modify “ Condensed DataWizard ” - “1D Bar Code Symbology” and “2D Bar Code Symbology”
Rev. D5	Mar. 06, 2014	❖ Modify “ Symbology Reading Control ” - “GS1 DataBar Setting” ❖ Add “ Appendix ” – “USB HID Legacy Mode” Quick Set
Rev. D6	Feb. 06, 2015	❖ Modify “ Symbology Reading Control ” - “MaxiCode Setting”
Rev. D7	Aug. 17, 2015	❖ Add “ Host Interface Selection ” – “USB EFT Terminal Mode”
Rev. D8	Dec. 25, 2015	❖ Revise “Revision History” ❖ Add “ Getting Started ” - A670 series scanner
Rev. D9	May 31, 2016	❖ Add “ Operation Control ” – “Buzzer Volume”
Rev. D10	Aug. 04, 2016	❖ Add “ Symbology Reading Control ” - “Small DM Code Reading”
Rev. D11	Oct. 11, 2016	❖ Modify “ Operation Control ” – “Buzzer Volume” ❖ Modify “ Operation Control ” – “Buzzer Tone Adjust”
Rev. D12	Jan. 23, 2017	❖ Modify “ Operation Control ” – “Buzzer Tone Adjust”
Rev. D13	Mar. 09, 2017	❖ Remove “ Operation Control ”- “Dollar Sign” ; Add “ Keyboard Interface Control ” - “Dollar Sign Control”
Rev. D14	March. 02, 2018	❖ Add new release model “A780” and “A680”. ❖ Modified “ Symbology Reading Control ” - “Readable Symbology Setting” – “Popular 1D” ❖ Modified “ Getting Familiar with Your FuzzyScan ” - A780 and A680 series scanner
Rev. D15	Sep. 20, 2018	❖ Added “ Operation Control ” - “Motion Control” ❖ Modified the description of “ Symbology Reading Control ” – “UPC/EAN Security Level” ❖ Added information on Code Pages ❖ Modified notes on Unique Barcode Reporting

Revision History

Rev. No.	Released Date	Description
Rev. D16	Nov. 22, 2018	❖ Improved “Symbology Reading Control” – “Code 128 Setting ISBT” - ISBT Concatenation settings
Rev. D17	March. 21, 2019	❖ Modified “ Symbology Reading Control ” – “QR Code Setting” – “Auto detect QR Code Inverse Reading” ❖ Modified “ Operation Control ” – “Motion Control”. Redefined “Motion Control” as “Scene Mode”.
Rev. E1	Nov. 28, 2019	❖ Added “ Serial Port Output ” ❖ Added “Alt-Code Keyboard” option code in “Keyboard Layout” family code
Rev. E2	Mar. 20, 2020	❖ Renamed “ Keyboard Layout Setting ” - “Alt-Code Keyboard” to “Universal” ❖ “ Keyboard Interface Control ” – “Function Key Emulation”: ❖ Renamed option “Enable ASCII 00-31 code as keyboard function code output” to “Enable Keyboard Function Code Table 1 Output” ❖ Renamed option “Ctrl-Output” to “Enable Keyboard Function Code Table 2 Output” ❖ Added option “Enable Keyboard Function Code Table 3 Output” ❖ Modified “ Appendix ” – “Keyboard Function Control Table”: ❖ Renamed column title “Key Function” to “Key Function 1” ❖ Renamed column title “Ctrl-Output” to “Key Function 2” ❖ Added column “Key Function 3”

© Copyright Cino Group
© Copyright PC Worth Int'l Co., Ltd

Cino makes no warranty of any kind with regard to this publication, including, but not limited to, the implied warranty of merchantability and fitness for any particular purpose. Cino shall not be liable for errors contained herein or for incidental consequential damages in connection with the furnishing, performance, or use of this publication. This publication contains proprietary information that is protected by copyright. All rights are reserved. No part of this publication may be photocopied, reproduced or translated into any language, in any forms, in an electronic retrieval system or otherwise, without prior written permission of Cino. All product information and specifications shown in this document may be changed without prior notice.

Warranty

Cino warrants its products against defects in workmanship and materials from the date of shipment, provided that the product is operated under normal and proper conditions. The warranty provisions and durations are furnished by different warranty programs. The above warranty does not apply to any product which has been (i) misused; (ii) damaged by accident or negligence; (iii) modified or altered by the purchaser or other party; (iv) repaired or tampered by unauthorized representatives; (v) operated or stored beyond the specified operational and environmental parameters; (vi) applied software, accessories or parts are not supplied by Cino; (vii) damaged by circumstances out of Cino's control, such as, but not limited to, lightning or fluctuation in electrical power. Any defective product must follow the warranty program and RMA procedures to return Cino for inspection.

Regulatory

 Part 15 Subpart B

 EN55022, EN55024, EN61000-3-2, EN61000-3-3,
EN60950-1, EN61000-6-3, EN61000-6-2

 CNS13438

 AS/NZS CISPR 22 Class B



KN22, KN24 (KN61000-2,-3,-4,-5,-6,-8,-11)



Class B ITE

LED Eye Safety IEC62471 Exempt group

Laser Eye Safety IEC60825-1 Class 1

Table of Contents

GETTING STARTED.....	1
Getting Familiar with Your Scanner	1
Connecting to Your Host.....	3
Using Accessories	4
CONFIGURING YOUR SCANNER	5
Barcode Programming Manual.....	5
Programming Procedures.....	6
Host Interface Selection.....	10
Symbology Reading Control.....	11
User Defined Symbol ID	11
Symbology ID Transmission	13
Readable Bar Code Setting	14
Code 39/Code 32 Setting.....	16
Code 39 Setting	17
Codabar/NW-7 Setting	18
UPC-A & UPC-E Setting	19
EAN Setting.....	22
UCC Coupon Extended Code Setting.....	25
IATA & Interleaved 2 of 5 Setting	26
Code 25 Family Setting.....	27
Code 11 & Code 93 Setting	28

MSI/Plessey Setting	29
Code 128 Setting	30
GS1-128 Setting.....	31
UK/Plessey Setting	32
Telepen Setting	33
GS1 DataBar Setting.....	34
Composite Codes, Codablock F, PDF417/MicroPDF417 Setting.....	35
Code 16K & Code 49 Setting.....	36
QR Code Setting	37
Data Matrix Setting.....	38
MaxiCode Setting.....	39
Aztec Code Setting	40
Australian Post, US Planet, US Postnet, British Post, & Japan Post Setting	41
Netherlands KIX Code, Intelligent Mail, & KoreaPost Code Setting.....	42
Keyboard Interface Control.....	43
Keyboard Layout (Language) Setting	43
Record Suffix, Preamble, Postamble, FNC1 Symbol Character Transmission	44
Caps Lock & Caps Lock Release Control.....	45
Delay Setting.....	46
Function Key & Key Pad Emulation, Upper/Lower Case Setting, Dollar Sign Control	47
Code Page: Barcode Encoding Format, Keyboard Output.....	48
Serial Interface Control.....	51
STX/ETX Control, Record Suffix, Preamble, Postamble, FNC1 Symbol Char. Transmission.....	51

Delay Setting.....	52
Protocol, ACK/NAK Setting	53
Response Time-out Setting, Baud Rate, Data Frame	54
Code Page: Barcode Encoding Format, Serial Port Output	55
Wand/Laser Emulation Control.....	57
Output Polarity, Signal State, Narrow/Wide Ratio, Margin & Module Time	57
Operation Control	59
Operation Mode	59
Presentation Control, Scan Rate, Flash Duty, SmartStand Power Off Timeout	60
LED Illumination Control, Illumination Delay.....	61
Laser Aiming Control, 1D Barcode Reading Direction.....	62
Operation Mode, Presentation & Illumination Control.....	63
Aiming Control, Delay Aiming Time-out Control, Decode Aiming Control.....	64
Center Alignment, Unique Barcode Reporting.....	65
Smart Scene	66
Batch Reading.....	67
Buzzer Tone Adjust, Power On & Good Read Indicator, Vibrator Control	71
Buzzer Volume.....	72
Redundancy & 1D Code Inverse Reading	73
Reread Delay & Good Read Delay Control	74
Light Source On Time, Hands Free Time-out, Good Read Duration, Time Delay to Low Power Mode.....	75
Presentation Auto-Sense & Sensitivity.....	76
Condensed DataWizard.....	77

Preamble, Postamble, Data Length, Symbol ID Transmission	77
Data Formatter Setting	78
Data Verifier Setting	79
Data Replacer Setting	80
Data Organizer Setting	81
APPENDIX	85
Symbology ID Table	86
Keyboard Function Code Table	88
Code Page – Table of Corresponding Languages	90
Code Page – Unicode Hex Input Setup	91
ASCII Input Shortcut	95
Host Interface Quick Set Commands	96
Operation Mode Quick Set Commands (<i>F & L Series</i>)	97
Operation Mode Quick Set Commands (<i>A Series</i>)	98
Option Codes	99
System Commands	100

GETTING STARTED

Getting Familiar with Your Scanner

Thank you for choosing Cino FuzzyScan Bar Code Scanner. All FuzzyScan scanners deliver world-class performance for a broad range of applications to unleash your productivity.

FuzzyScan family includes **A** series area imager, **F** series linear imager and **L** series laser imager. The **Antimicrobial** models are available for A770, L780 and F780 series scanners which are equipped with Disinfectant-ready Housing and Vibrator. Moreover, the option of **Vibrator** is available for all other series upon request. For more details, please visit our web site or contact your supplier.

This document provides an easy reference for installation and operation purpose. The complete documentation is available at www.cino.com.tw.

A770 Series

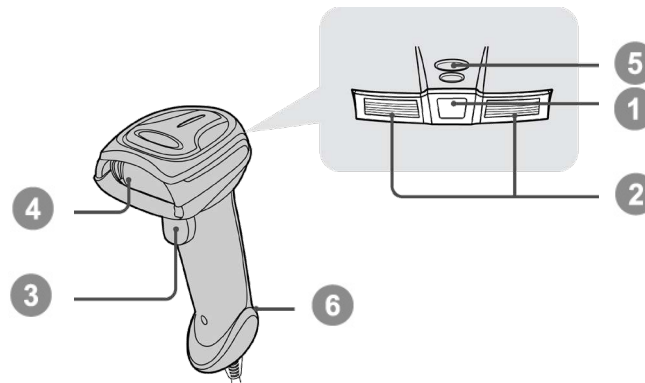

A780 Series

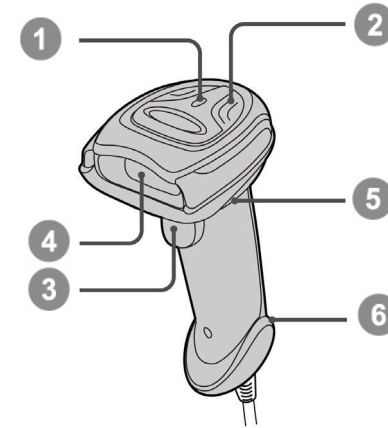

A680BT Series

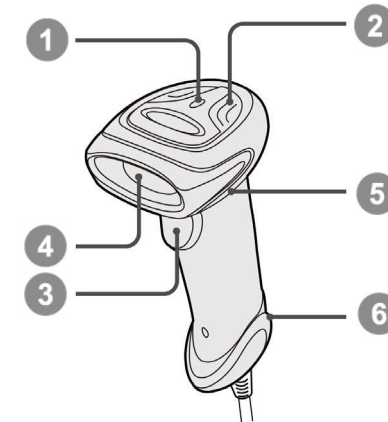

- | | |
|--------------------|----------------------|
| 1 Power Indicator | 4 Scan Window |
| 2 Status Indicator | 5 Beeper |
| 3 Trigger | 6 Cable Release Hole |

F790/F780/ L780 Series

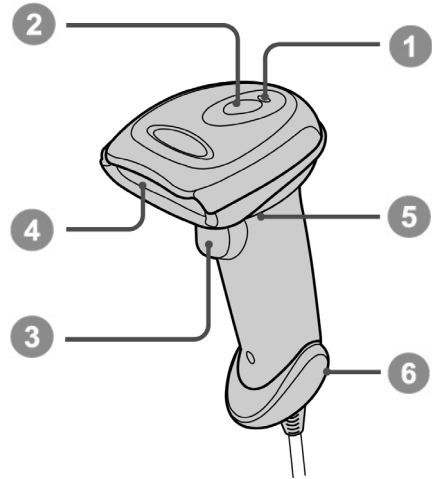

A670/F680/L680 Series

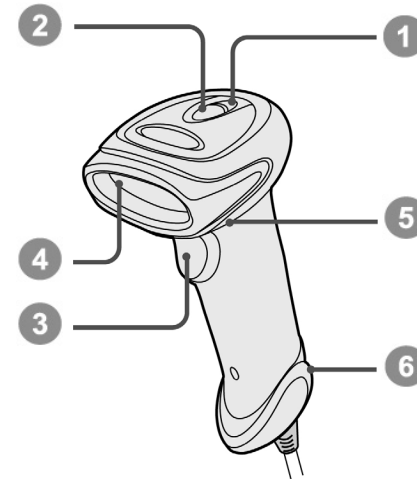

F560 Series

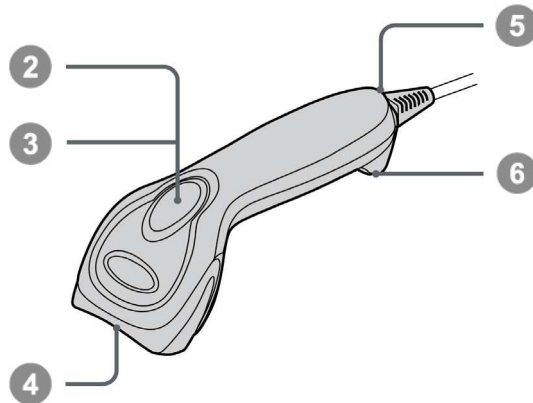

Connecting to Your Host

FuzzyScan scanners support USB and RS-232 Serial interfaces. Please choose your desired interface cable, then plug it into the cable interface port of the scanner and connect it to the host. If you would like to remove the cable, please straighten one end of a paper clip, and then insert it into the cable release hole to pull out the cable.

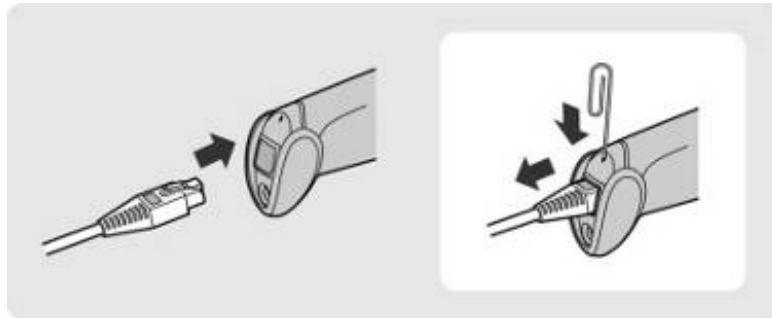
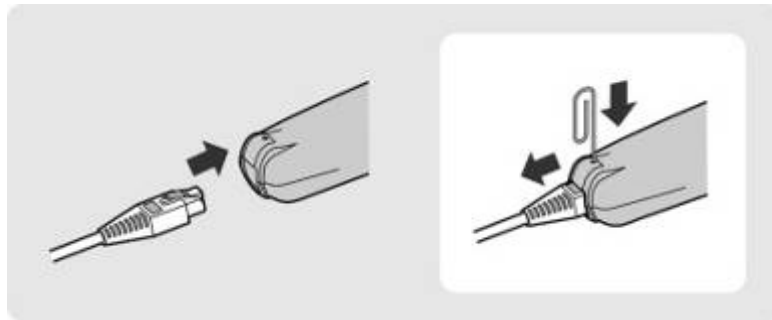

RS232 Serial



USB HID & USB COM



Using Accessories

You can enhance productivity of your workforce by using various accessories to fulfill a wide variety of application demand.

Universal Holder

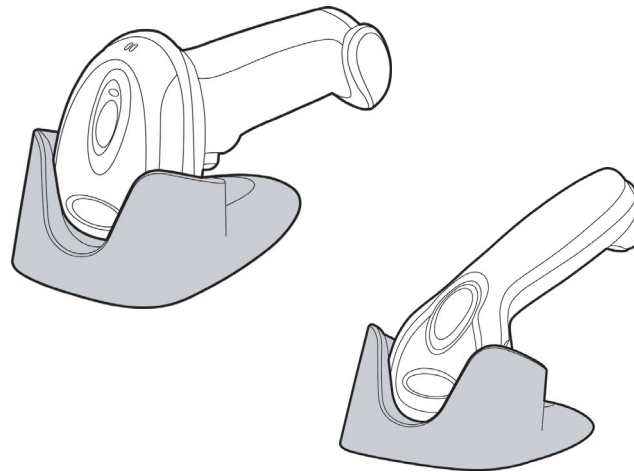

The stylish Universal Holder is designed for storing your scanner when not in use. It serves to protect the scanner from lens-scratched or falling. Moreover, its artistic-design enhances the entire value of the scanner. But please note that the holder is not applicable for **A series** scanners.

Hand-free SmartStand

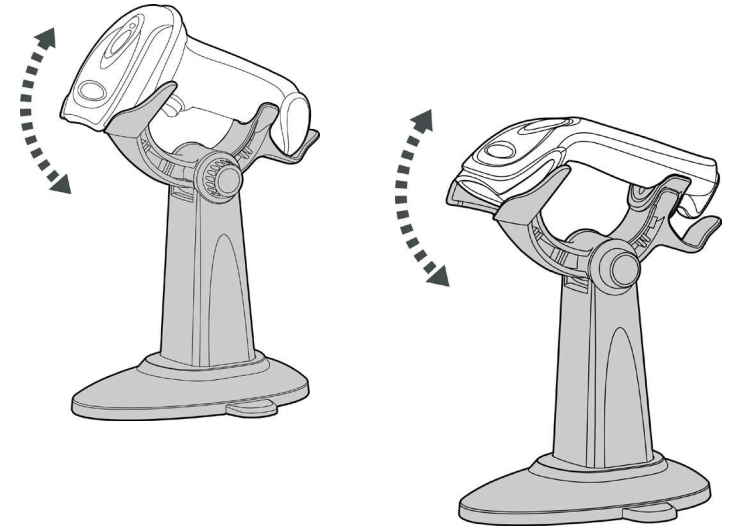

SmartStand is specifically designed for hand-free applications to maximize user's comfort and productivity. You can adjust the scanner holder to desired position for optimized scanning.

Thanks to the auto-sense design, the scanner is capable of switching between presentation scanning and hand-held scanning automatically while working with SmartStand. But please note that this feature is not available for **F500** series scanners.

In presentation mode, the barcode may not be detected by the scanner in an environment with very dim ambient lighting. You can select higher sensitivity level through the setting of **Presentation Sensitivity** to increase scanner's sensitivity.

CONFIGURING YOUR SCANNER

Barcode Programming Manual

The FuzzyScan bar code commands are specially designed **Proprietary** bar code labels which allow you to set the FuzzyScan internal programming parameters. There are **System Command**, **Family Code** and **Option Code** for programming purpose.

Each programmable family and bar code command label is listed on the same page with major system commands. The detailed explanations and special programming flowchart are printed on facing or following pages. You can read the explanation and set the FuzzyScan concurrently.

A supplemental bar code command menu incorporates the bar code command labels of System Command and Option Code. As you set the FuzzyScan, open the bar code command menu to find the option code page. You may scan the desired family code and option code to set FuzzyScan. If you want to change the programming family for multiple settings, you need only turn over the programming page to find next desired programming family.

System Command

The System Command is the highest level bar code command which directs FuzzyScan to perform immediate operations, such as entering programming mode (**PROGRAM**), exiting programming mode (**EXIT**), listing system information (**SYSLIST**), recovering to factory preset configurations (M_DEFAULT) and so on. Please note that all system commands will take a few seconds to complete the operations. User must wait for the completion beeps before scanning another bar code.

Family Code

The Family Code is scanned to select the user desired programming family. FuzzyScan has already provided more than one hundred programming families to meet any specific requirements.

Option Code

The Option Codes is a set of bar code commands represented by “0–9”, “A–F” and finishing selection (**FIN**). For most setting, you must select at least one option code following the family code selection to set the desired parameter for the selected programming family.

Programming Procedures

As you scan the bar code command to select the desired parameters, information about the final selected parameters represented by the bar code commands are stored in the FuzzyScan's internal Flash Memory ASIC or memory. If you turn off the unit, the Flash Memory ASIC or non-volatile memory retains all programming options. You need not re-program the FuzzyScan if you want to keep the existing configurations in the next power on.

The programming procedures of FuzzyScan are designed as simple as possible for ease of setting. Most programming families take the **Single Scan Selection** programming procedure. But several programming families have more complex and flexible programmable options, and you must take **Multiple Scans Selection, Cycling Scan Selection or Dual Level Selection** to complete their programming procedures. Each kind of programming procedure is listed in the following pages for your reference. Please give careful attention to become familiar with each programming procedure.

If the programming family must take multiple scans selection, cycling scan selection, or dual level selection procedures, the family of the programming menu will be marked with the matched representing symbol of **Programming Category** (P.C.) in bold font listed in the following table. You can easily find the bold mark in the programming menu, and refer to their flowcharts for details. Before setting the FuzzyScan, please also refer to the "Beeping Indications" listed in Appendix to understand the details of programming beeping indications. It will be very helpful for you to know the existing status while you are programming the FuzzyScan.

Conventions of Programming Menu

Conventions	Descriptions
◆	Factory Default Value
P.C.	Programming Category SS : Single scan selection MS : Multiple scans selection CS : Cycling scan selection DS : Dual level scan selection
()	Necessary Option Code
[]	Selectable Option Code

Program & End

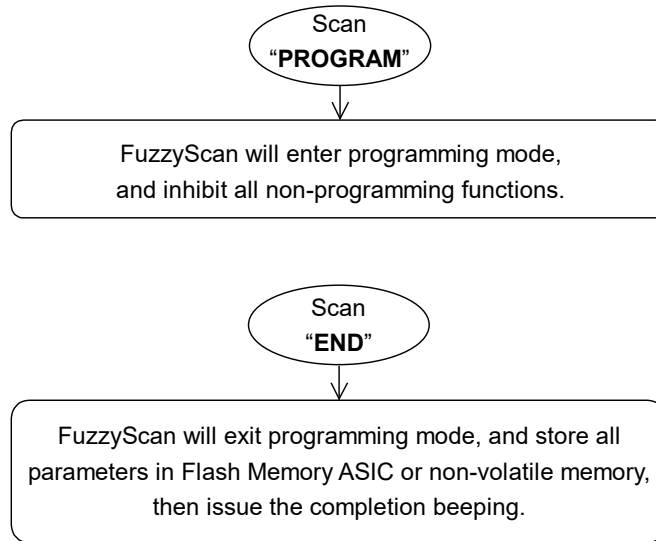

System List, Group & Master Default

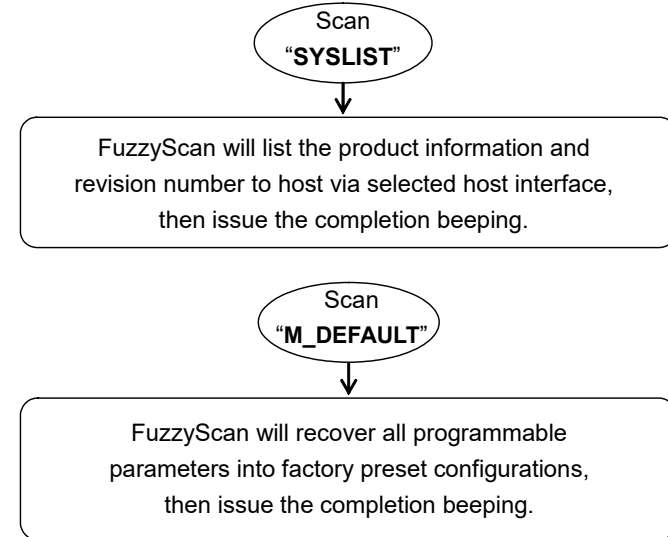

Please note that the FuzzyScan will take 3-4 seconds to store parameters in internal Flash Memory ASIC or non-volatile memory after you scan the **“END”**. Please **don't** turn off the power before the completion beeping. It may destroy all configured parameters.



Single scan selection

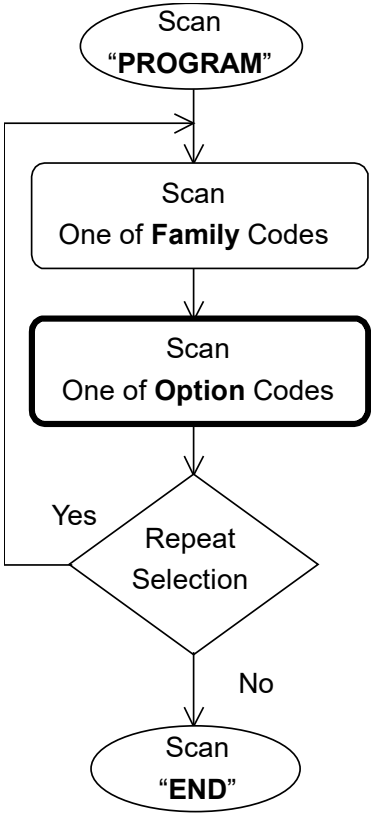

Enter programming mode.

Select one of desired programming families.

Select one option code of desired parameter.

Want to select another programming family?

Exit programming mode.

Multiple scans selection

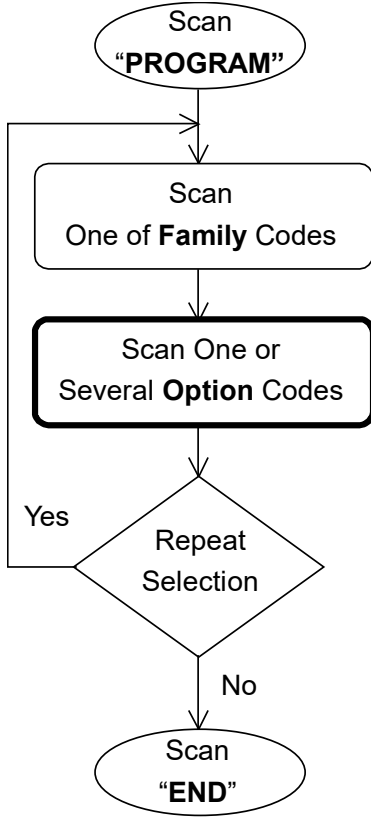

Enter programming mode.

Select one of desired programming families.

1. Select one or several option codes to select desired parameters.
2. If it's necessary, scan "FIN" to terminate option code selection.

Want to select another programming family?

Exit programming mode.



Cycling scan selection

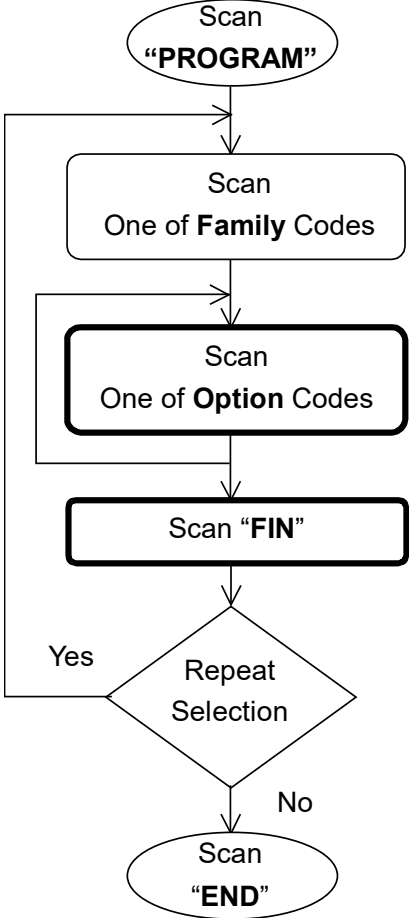

Enter programming mode.

Select one of desired programming families.

Cycling select one or several option codes of desired parameters as "Single" or "Multiple" scans selection.

Finish cycling selection. (If necessary)

Want to select another programming family?

Exit programming mode.

Dual level selection

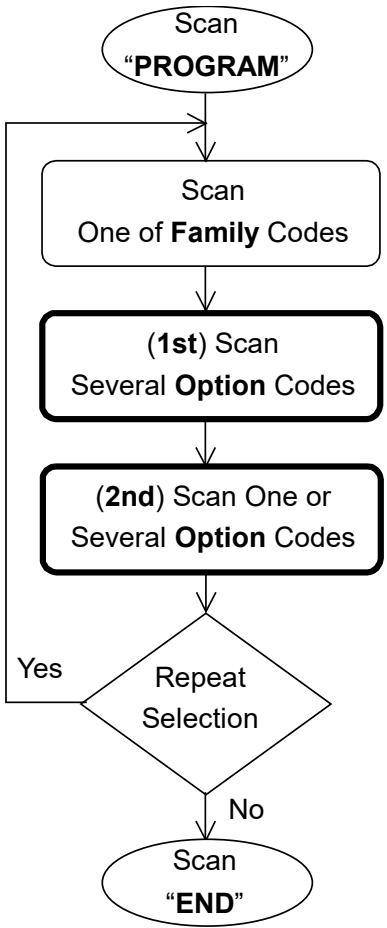

Enter programming mode.

Select one of desired programming families.

Select several option codes of desired parameters.

1. Select one or several option codes of desired parameters.
2. If it's necessary, scan "FIN" to terminate option code selection.

Want to select another programming family?

Exit programming mode.



PROGRAM

Host Interface Selection



F_DEFAULT

Family Code Selection	P.C	Parameter Selection	Option Code
Host Interface Selection 	MS	IBM PS/2, 25-30 series keyboard wedge interface	02
	MS	Standard/TTL RS-232 peer-to-peer serial	06
	MS	Wand Emulation	08
	MS	USB Com Port Emulation	09
	MS	PS/2 (DOS/V) direct link (keyboard replacement)	10
	MS	PS/2 (DOS/V) keyboard wedge turbo mode	13
	MS	PS/2 (DOS/V) keyboard wedge standard mode	14
	MS	Laser emulation	17
	MS	USB HID standard mode ◆	18
	MS	USB HID turbo mode	19
	MS	USB HID Legacy	20
	MS	USB EFT Terminal Mode	21

■ **A series** doesn't support Wand emulation, Laser emulation, USB HID Legacy Mode.



PROGRAM

Symbology Reading Control User Defined Symbol ID



F_DEFAULT

Family Code Selection	P.C	Parameter Selection	Option Code	2nd Option Code
Symbol ID : 1 character 	DS	Code 128 (default= B)	00	(1 character)
		GS1-128 (default= C)	01	(1 character)
		UPC-A (default= A)	02	(1 character)
		EAN-13 (default= F)	03	(1 character)
		Codabar/NW-7 (default= D)	04	(1 character)
		Code 39/Code 32 (default= G)	05	(1 character)
		Code 93 (default= H)	06	(1 character)
		Standard/Industrial 2 of 5 (default= I)	07	(1 character)
		Interleaved 2 of 5 (default= J)	08	(1 character)
		Matrix 2 of 5 (default= K)	09	(1 character)
		China Postal Code (default= L)	10	(1 character)
		German Postal Code (default= M)	11	(1 character)
		IATA (default= O)	12	(1 character)
		Code 11 (default= P)	13	(1 character)
		MSI/Plessey (default= R)	14	(1 character)
		UK/Plessey (default= S)	15	(1 character)
		Telepen (default= T)	16	(1 character)
		GS1 DataBar (default= X)	17	(1 character)
		UPC-E (default= E)	18	(1 character)
		EAN-8 (default= N)	19	(1 character)
		Trioptic Code 39 (default= W)	20	(1 character)
		UCC Coupon Extended Code (default= Z)	21	(1 character)
		PDF417/Micro PDF417 (default= V)	22	(1 character)
		Codablock F (default= Y)	23	(1 character)
		Code 16K (default= Q)	24	(1 character)
		Code 49 (default= U)	25	(1 character)
		Korea Post Code (default= a)	26	(1 character)
		QR & Micro QR Code (default= b)	28	(1 character)
		Data Matrix (default= c)	29	(1 character)
		Maxi Code (default= d)	30	(1 character)



PROGRAM

Symbology Reading Control User Defined Symbol ID (continued)



F_DEFAULT

Family Code Selection	P.C	Parameter Selection	Option Code	2nd Option Code
Symbol ID : 1 character 	DS	Aztec Code (default=e) Chinese Sensible (default=f) Australian Post (default=g) British Post (default=h) Intelligent Mail (USPS 4CB/One Code) (default=j) Japan Post (default=k) Netherlands KIX Post (default=l) US Planet (default=m) US Postnet (default=o)	31 32 33 34 36 37 38 39 41	(1 character) (1 character) (1 character) (1 character) (1 character) (1 character) (1 character) (1 character) (1 character)



PROGRAM

Symbology Reading Control Symbology ID Transmission



F_DEFAULT

Family Code Selection	P.C	Parameter Selection	Option Code
Symbology ID Transmission 	SS	Disable symbology ID transmission ◆	0
	SS	Enable prefix CINO symbology ID transmission	1
	SS	Enable suffix CINO symbology ID transmission	2
	SS	Enable both prefix and suffix CINO symbology ID transmission	3
	SS	Enable prefix AIM symbology ID transmission	4
	SS	Enable suffix AIM symbology ID transmission	5
	SS	Enable both prefix and suffix AIM symbology ID transmission	6



PROGRAM

Symbology Reading Control Readable Bar Code Setting



F_DEFAULT

Family Code Selection	P.C	Parameter Selection	Option Code
Readable Symbology Setting  <div style="border: 1px solid black; padding: 5px; width: fit-content;"> Remember to scan "FIN" to terminate this selection. But if you select the "Auto", FuzzyScan will terminate this selection automatically. </div>	SS	Auto ◆	00
	CS	Popular 1D	C0
	CS	Code 128 *	01
	CS	GS1-128 *	31
	CS	UPC-A *	02
	CS	UPC-E *	03
	CS	EAN-13 *	04
	CS	EAN-8 *	05
	CS	Codabar/NW-7 *	06
	CS	Code 39 *	07
	CS	Trioptic Code 39	47
	CS	Standard/Industrial 2 of 5	08
	CS	Matrix 2 of 5	38
	CS	Interleaved 2 of 5 *	48
	CS	China Postal Code	58
	CS	Germany Postal Code	68
	CS	Code 93 *	09
	CS	Code 11	10
	CS	MSI/Plessey	11
	CS	UK/Plessey	12
	CS	Telepen	13
	CS	GS1 DataBar (RSS-14) *	14
	CS	IATA	15
	CS	PDF417 * /Micro PDF417	17
	CS	Codablock F	18
	CS	Code 16K	19
	CS	Code 49	20
CS	Korea Post Code	21	
CS	QR Code * / Micro QR Code *	A0	
CS	Data Matrix *	A1	
CS	MaxiCode	A2	
CS	Aztec Code *	A3	
CS	Chinese Sensible (Han Xin) Code	A4	



PROGRAM

Symbology Reading Control Readable Bar Code Setting (continued)



F_DEFAULT

Family Code Selection	P.C	Parameter Selection	Option Code
Readable Symbology Setting 	CS	Australian Post	B0
	CS	British Post	B1
	CS	Intelligent Mail barcode	B3
	CS	Japanese Post	B4
	CS	KIX Post	B5
	CS	Planet Code	B6
	CS	Postnet	B8

- If your application is known, you may select those known symbologies only to increase the reading speed and decrease the possibility of reading error. Furthermore, to add the "Symbology ID" into the transmitted data is also helpful to identify the specific symbology.
- Above symbologies marketed with * are enabled as default. When you select "Auto", the scanner only reads those symbologies marked with *.
- "Popular 1D" includes "Code 128", "GSA-128", "UPC-A", "UPC-E", "EAN-13", "EAN-8", "Codabar/NW-7", "Code 39", "Interleaved 2 of 5", "Code 93", "GS1 DataBar (RSS-14)".
- When you set the minimum and maximum length of each symbology, please note the data length of scanned bar code doesn't include start/stop characters.





PROGRAM

Symbology Reading Control Code 39/Code 32 Setting

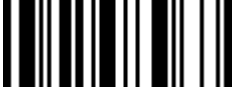

F_DEFAULT

Family Code Selection	P.C	Parameter Selection	Option Code
Code 39 Family Setting 	SS	Disable Code 39	0
	SS	Enable Code 39 ◆	1
	SS	Select Standard Code 39 as primary format ◆	2
	SS	Select Full ASCII Code 39 as primary format	3
	SS	Select Code 32 (PARAF, Italian Pharmaceutical) as primary format	4
	SS	Disable start/stop symbol transmission ◆	5
	SS	Enable start/stop symbol transmission	6
	SS	Disable Code 32 leading A transmission ◆	7
	SS	Enable Code 32 leading A transmission	8
	SS	Disable MOD 43 check digit verification ◆	9
	SS	Enable MOD 43 check digit verification	A
	SS	Disable check digit transmission ◆	B
	SS	Enable check digit transmission	C
	SS	Disable Code 39 buffering ◆	D
SS	Enable Code 39 buffering	E	
Trioptic Code 39 Setting 	SS	Disable Trioptic Code 39 ◆	0
	SS	Enable Trioptic Code 39	1
Code 39 Min. Length 	SS	Default (01) ◆	FIN (2 digits)
	MS	01-Maximum Scan 2 digits from the option code chart in Appendix; then FuzzyScan will terminate this selection automatically.	
Code 39 Max. Length 	SS	Default (98) ◆	FIN (2 digits)
	MS	98-Minimum Scan 2 digits from the option code chart in Appendix; then FuzzyScan will terminate this selection automatically.	

▪ Trioptic Code 39 and Code 39 Full ASCII cannot be enabled simultaneously.



PROGRAM

Symbology Reading Control Code 39 Setting



F_DEFAULT

Family Code Selection	P.C	Parameter Selection	Option Code
Code 39 Security Level 	SS	Level 0	0
	SS	Level 1	1
	SS	Level 2 ◆	2
	SS	Level 3	3

▪ **Code 39 Security Level**

The scanner offers four levels of decode security for Code39 bar codes:

Level 0: If you are experiencing misread of poorly-printed or serious out-of-spec. bar codes in level 1, please select level 0.

Level 1: If you are experiencing misread of poorly-printed or out-of-spec. bar codes in level 2, please select level 1.

Level 2: This is the default setting which allows the scanner to operate fastest, while providing sufficient security in decoding "in-spec" Code39 bar codes.

Level 3: If you failed to read poorly-printed or out-of-spec. bar codes in level 2, please select level 3. This is the most aggressive setting and may increase the misread.







PROGRAM

Symbology Reading Control Codabar/NW-7 Setting



F_DEFAULT

Family Code Selection	P.C	Parameter Selection	Option Code
Codabar Setting 	SS SS SS SS SS SS SS SS SS SS SS SS SS SS SS SS SS	Disable Codabar Enable Codabar ◆ Select Codabar standard format ◆ Select Codabar ABC format Select Codabar CLSI format Select Codabar CX format Disable start/stop symbol transmission ◆ Enable ABCD/ABCD start/stop symbol transmission Enable abcd/abcd start/stop symbol transmission Enable ABCD/TN*E start/stop symbol transmission Enable abcd/tn*e start/stop symbol transmission Disable check digit verification ◆ Enable check digit verification Disable check digit transmission ◆ Enable check digit transmission	0 1 2 3 4 5 6 7 8 9 A B C D E
Codabar Check Digit Settings 	SS SS SS SS SS SS SS	Modulus 16 ◆ Modulus 10/weight 3 Modulus 11 Modulus 10/weight 2 7 check DR Weight Modulus 11 Runes (Modulus 10/weight 2)	0 1 2 3 4 5 6
Codabar Min. Length 	SS MS	Default (04) ◆ 01-Maximum Scan 2 digits from the option code chart in Appendix; then FuzzyScan will terminate this selection automatically.	FIN (2 digits)
Codabar Max. Length 	SS MS	Default (98) ◆ 98-Minimum Scan 2 digits from the option code chart in Appendix; then FuzzyScan will terminate this selection automatically.	FIN (2 digits)



PROGRAM

Symbology Reading Control UPC-A & UPC-E Setting



F_DEFAULT

Family Code Selection	P.C	Parameter Selection	Option Code
UPC Family Setting 	SS	Disable UPC-A	0
	SS	Enable UPC-A ◆	1
	SS	Disable UPC-E	2
	SS	Enable UPC-E ◆	3
	SS	Disable UPC-E expansion ◆	4
	SS	Enable UPC-E expansion	5
	SS	Disable UPC standardization ◆	6
	SS	Enable UPC standardization	7
	SS	Disable UPC numeric system	8
	SS	Enable UPC numeric system ◆	9
	SS	Disable UPC-A check digit transmission	A
	SS	Enable UPC-A check digit transmission ◆	B
	SS	Disable UPC-E check digit transmission	C
	SS	Enable UPC-E check digit transmission ◆	D
SS	Disable UPC "leading 1" portion ◆	E	
SS	Enable UPC "leading 1" portion	F	

- When enable UPC-E expansion, the UPC-E decoded data will be converted to UPC-A format and affected by related setting, such as UPC standardization, UPC numeric system, UPC-A check digit transmission.
- **UPC-E & EAN-8 Expansion** : Expand the 8-digit UPC-E and 8-digit EAN-8 to 12-digit UPC-A and 13-digit EAN-13.
- **UPC-A Standardization** : Expand the 12-digit UPC-A to 13-digit EAN-13 with 1 zero insertion.
- **UPC Lead 1 Numeric System** : To read UPC leading with the 1 numeric system, you must enable this option.

WPC Selection (UPC/EAN/CAN)	Basic Length	Disable Check Digit	Disable Numeric System	With 2-digit Addendum	With 5-digit Addendum	Enable Standardization	Enable Expansion
UPC-A	12	- 1	- 1	+ 2	+ 5	+ 1	0
UPC-E	8	- 1	- 1	+ 2	+ 5	+ 1	+ 4
EAN-13	13	- 1	NC	+ 2	+ 5	NC	0
EAN-8	8	- 1	NC	+ 2	+ 5	NC	+ 5





PROGRAM

Symbology Reading Control UPC-A & UPC-E Setting (continued)



F_DEFAULT

Family Code Selection	P.C	Parameter Selection	Option Code
UPC Supplement Setting 	SS	Select UPC without supplement digits ◆	0
	SS	Select UPC with only 2 supplement digits	1
	SS	Select UPC with only 5 supplement digits	2
	SS	Select UPC with 2/5 supplement digits	3
	SS	Disable force supplement digits output ◆	4
	SS	Enable force supplement digits output	5
	SS	UPC Family Addenda Separator Off ◆	6
	SS	UPC Family Addenda Separator On	7
UPC/EAN Security Level 	SS	Level 0	0
	SS	Level 1 ◆	1
	SS	Level 2	2
		Only available for UPC-A & EAN-13	
Supplement Scan Voting 	SS	None	0
	SS	Level 1	1
	SS	Level 2	2
	SS	Level 3 ◆	3
	SS	Level 4	4
	SS	Level 5	5
	SS	Level 6	6
	SS	Level 7	7
	SS	Level 8	8
	SS	Level 9	9
	SS	Level 10	A
	SS	Level 11	B
	SS	Level 12	C
	SS	Level 13	D

▪ **UPC/EAN Security Level**

The scanner offers three levels of decode security for UPC/EAN bar codes:

Level 0: If you are experiencing misread of poorly-printed or out-of-spec. bar codes, especially in characters 1, 2, 7, and 8 in level 1, please select level 0. Selection of this security level may significantly impair the decoding ability of the scanner.

Level 1: This is the default setting which allows the scanner to operate fastest, while providing sufficient security in decoding “in-spec” UPC/EAN bar codes.

Level 2: If you failed to read poorly-printed or out-of-spec. bar codes in level 1, please select level 2. This is the most aggressive setting and may increase the misread.

- The **Supplement Scan Voting** is the number of times the same UPC/EAN with 2/5 supplement digits has to be decoded before it is transmitted. It is helpful when decoding a mix of UPC/EAN symbols with and without supplement digits. This function is effective when you select UPC/EAN with only 2 supplement digits, UPC/EAN with only 5 supplement digits or UPC/EAN with 2/5 supplement digits. The default value is Level 3. When you select higher level, it may impact the reading speed on poorly-printed, low contrast or damage barcode labels.





PROGRAM

Symbology Reading Control EAN Setting



F_DEFAULT

Family Code Selection	P.C	Parameter Selection	Option Code
EAN Setting 	SS	Disable EAN-13	0
	SS	Enable EAN-13 ◆	1
	SS	Disable EAN-8	2
	SS	Enable EAN-8 ◆	3
	SS	Disable EAN-8 expansion ◆	4
	SS	Enable EAN-8 expansion	5
	SS	Disable EAN-13 check digit transmission	6
	SS	Enable EAN-13 check digit transmission ◆	7
	SS	Disable EAN-8 check digit transmission	8
	SS	Enable EAN-8 check digit transmission ◆	9
	SS	Disable ISBN/ISSN Conversion reading check ◆	A
	SS	Enable ISBN/ISSN Conversion reading check	B
	EAN Supplement Setting 	SS	Select EAN without supplement digits ◆
SS		Select EAN with only 2 supplement digits	1
SS		Select EAN with only 5 supplement digits	2
SS		Select EAN with 2/5 supplement digits	3
SS		Disable force supplement digits output ◆	4
SS		Enable force supplement digits output	5
SS		EAN Addenda Separator Off ◆	6
SS		EAN Addenda Separator On	7
Supplement Scan Voting 	SS	None	0
	SS	Level 1	1
	SS	Level 2	2
	SS	Level 3 ◆	3
	SS	Level 4	4
	SS	Level 5	5
	SS	Level 6	6
	SS	Level 7	7
	SS	Level 8	8
	SS	Level 9	9
	SS	Level 10	A
	SS	Level 11	B
	SS	Level 12	C
	SS	Level 13	D

- The Supplement Scan Voting is the number of times the same UPC/EAN with 2/5 supplement digits has to be decoded before it is transmitted. It is helpful when decoding a mix of UPC/EAN symbols with and without supplement digits. This function is effective when you select UPC/EAN with only 2 supplement digits, UPC/EAN with only 5 supplement digits or UPC/EAN with 2/5 supplement digits. The default value is Level 3. When you select higher level, it may impact the reading speed on poorly-printed, low contrast or damage barcode labels.







PROGRAM

Symbology Reading Control EAN Setting



F_DEFAULT

Family Code Selection	P.C	Parameter Selection	Option Code
UPC/EAN Security Level 	SS	Level 0	0
	SS	Level 1 ◆	1
	SS	Level 2	2
		Only available for UPC-A & EAN-13	
EAN Supplement Control 	SS	Disable all specific prefix supplement digital output ◆	0
	SS	Enable all specific prefix supplement digital output	1
	SS	Enable 491 Supplement Digit Output	2
	SS	Enable 978/979 Supplement Digit Output	3
	SS	Enable 977 Supplement Digit Output	4
	SS	Enable 378/379 Supplement Digit Output	5
	SS	Enable 414/419 Supplement Digit Output	6
SS	Enable 434/439 Supplement Digit Output	7	

▪ **UPC/EAN Security Level**

The scanner offers three levels of decode security for UPC/EAN bar codes:

Level 0: If you are experiencing misread of poorly-printed or out-of-spec. bar codes, especially in characters 1, 2, 7, and 8 in level 1, please select level 0. Selection of this security level may significantly impair the decoding ability of the scanner.

Level 1: This is the default setting which allows the scanner to operate fastest, while providing sufficient security in decoding “in-spec” UPC/EAN bar codes.

Level 2: If you failed to read poorly-printed or out-of-spec. bar codes in level 1, please select level 2. This is the most aggressive setting and may increase the misread.

▪ **EAN Supplement Control**

If you select EAN with only 2, or 5 or 2/5 supplement digits and enable 491 prefix supplement digit output, the scanner will transmit EAN with 2, or 5 or 2/5 supplement digits bar codes starting with 491 prefix. The EAN without supplement digit **will not** be transmitted.

If you select EAN with only 2, or 5 or 2/5 supplement digits and enable the other except 491 prefix supplement digit output, the scanner will transmit EAN with 2, or 5, or 2/5 supplement digits bar codes starting with specific prefix. The EAN without supplement digit **will** be transmitted.



PROGRAM

Symbology Reading Control UCC Coupon Extended Code Setting



F_DEFAULT

Family Code Selection	P.C	Parameter Selection	Option Code
UCC Coupon Extended Code 	SS	Disable UCC Coupon Extended Code ◆	0
	SS	Enable UCC Coupon Extended Code	1

- UCC Coupon Extended Code
When UCC coupon extended code function is enabled, scanner decodes UPC-A barcodes starting with digit “5”, EAN-13 barcodes starting with digit “99” and GS1-128 Coupon Codes. UPC-A, EAN-13 and EAN-128 must be enabled to scan all types of Coupon Codes.





PROGRAM

Symbology Reading Control IATA & Interleaved 2 of 5 Setting



F_DEFAULT

Family Code Selection	P.C	Parameter Selection	Option Code
IATA Setting 	SS	Disable IATA ◆	0
	SS	Enable IATA	1
	SS	Select 15-digit fixed length IATA checking ◆	2
	SS	Select variable length IATA	3
	SS	Disable check digit verification ◆	4
	SS	Enable check digit automatic verification	5
	SS	Enable S/N checking digit verification only	6
	SS	Enable CPN checking digit verification only	7
	SS	Enable CPN, Airline and S/N check digit verification	8
	SS	Disable check digit transmission ◆	9
	SS	Enable check digit transmission	A
	SS	Disable start/stop symbol transmission ◆	B
	SS	Enable start/stop symbol transmission	C
	Interleaved 2 of 5 Setting 	SS	Disable Interleaved 2 of 5
SS		Enable Interleaved 2 of 5 ◆	1
SS		Select Interleaved 2 of 5 as primary format ◆	2
SS		Select German Postal Code as primary format	3
SS		No check character ◆	4
SS		Validate USS check digit	5
SS		Validate OPCC check digit	6
SS		Disable check digit transmission ◆	7
SS		Enable check digit transmission	8





PROGRAM

Symbology Reading Control Code 25 Family Setting



F_DEFAULT

Family Code Selection	P.C	Parameter Selection	Option Code
Code 25 Setting 	SS	Disable Standard/Industrial 2 of 5 ◆	0
	SS	Enable Standard/Industrial 2 of 5	1
	SS	Disable Matrix 2 of 5 ◆	2
	SS	Enable Matrix 2 of 5	3
	SS	Disable China Postal Code ◆	4
	SS	Enable China Postal Code	5
	SS	Disable check digit verification ◆	6
	SS	Enable check digit verification	7
	SS	Disable check digit transmission ◆	8
SS	Enable check digit transmission	9	
Code 25 Family Min. Length 	SS	Default (04) ◆	FIN (2 digits)
	MS	01-Maximum Scan 2 digits from the option code chart in Appendix; then FuzzyScan will terminate this selection automatically.	
Code 25 Family Max. Length 	SS	Default (98) ◆	FIN (2 digits)
	MS	98-Minimum Scan 2 digits from the option code chart in Appendix; then FuzzyScan will terminate this selection automatically.	

▪ For Code25 setting, we recommend you to select **only one** type of Code 25 or set the **maximum/minimum bar code length**. To decode all types of Code 25 or to variable length of Code 25 will increase the possibility of reading error.



PROGRAM

Symbology Reading Control Code 11 & Code 93 Setting



F_DEFAULT

Family Code Selection	P.C	Parameter Selection	Option Code
Code 11 Setting 	SS	Disable Code 11 ◆	0
	SS	Enable Code 11	1
	SS	Disable check digit verification ◆	2
	SS	Select 1-check digit verification	3
	SS	Select 2-check digit verification	4
	SS	Disable check digit transmission ◆	5
	SS	Enable check digit transmission	6
Code 11 Min. Length 	SS	Default (04) ◆	FIN (2 digits)
	MS	01-Maximum Scan 2 digits from the option code chart in Appendix; then FuzzyScan will terminate this selection automatically.	
Code 11 Max. Length 	SS	Default (98) ◆	FIN (2 digits)
	MS	98-Minimum Scan 2 digits from the option code chart in Appendix; then FuzzyScan will terminate this selection automatically.	
Code 93 Setting 	SS	Disable Code 93	0
	SS	Enable Code 93 ◆	1
	SS	Disable check digit transmission ◆	2
	SS	Enable check digit transmission	3
Code 93 Min. Length 	SS	Default (01) ◆	FIN (2 digits)
	MS	01-Maximum Scan 2 digits from the option code chart in Appendix; then FuzzyScan will terminate this selection automatically.	
Code 93 Max. Length 	SS	Default (98) ◆	FIN (2 digits)
	MS	98-Minimum Scan 2 digits from the option code chart in Appendix; then FuzzyScan will terminate this selection automatically.	





PROGRAM

Symbology Reading Control MSI/Plessey Setting



F_DEFAULT

Family Code Selection	P.C	Parameter Selection	Option Code
MSI/Plessey Setting 	SS	Disable MSI/Plessey ◆	0
	SS	Enable MSI/Plessey	1
	SS	Select MOD 10 check digit ◆	2
	SS	Select MOD 10-10 check digit	3
	SS	Select MOD 11-10 check digit	4
	SS	Disable check digit transmission ◆	5
	SS	Enable check digit transmission	6
MSI/Plessey Min. Length 	SS	Default (04) ◆	FIN (2 digits)
	MS	01-Maximum Scan 2 digits from the option code chart in Appendix; then FuzzyScan will terminate this selection automatically.	
MSI/Plessey Max. Length 	SS	Default (98) ◆	FIN (2 digits)
	MS	98-Minimum Scan 2 digits from the option code chart in Appendix; then FuzzyScan will terminate this selection automatically.	



PROGRAM

Symbology Reading Control Code 128 Setting



F_DEFAULT

Family Code Selection	P.C	Parameter Selection	Option Code
Code 128 Setting 	SS	Disable Code 128	0
	SS	Enable Code 128 ◆	1
	SS	ISBT Concatenation Off ◆	2
	SS	ISBT Concatenation On	3
	SS	ISBT Concatenation On – Check ISBT table	4
	SS	ISBT Concatenation Auto	5
Code 128 Min. Length 	SS	Default (01) ◆	FIN (2 digits)
	MS	01-Maximum Scan 2 digits from the option code chart in Appendix; then FuzzyScan will terminate this selection automatically.	
Code 128 Max. Length 	SS	Default (98) ◆	FIN (2 digits)
	MS	98-Minimum Scan 2 digits from the option code chart in Appendix; then FuzzyScan will terminate this selection automatically.	
Code 128 Security Level 	SS	Level 0	0
	SS	Level 1 ◆	1

▪ **Code 128 Setting**

ISBT Concatenation Off: The scanner will not output ISBT concatenated barcodes.

ISBT Concatenation On: The scanner will only decode and output ISBT concatenated barcodes. The scanner will not decode or output single ISBT barcodes.

ISBT Concatenation On – Check ISBT table: The scanner will only output ISBT concatenated barcodes that conform to ICCBBA standards. The scanner will not output single ISBT barcodes or ISBT concatenated barcodes that do not conform to ICCBBA standards.

ISBT Concatenation Auto: The Scanner will decode and output both ISBT concatenated barcodes and single ISBT barcodes.

▪ **Code 128 Security Level**

The scanner offers two levels of decode security for Code128 bar codes:

Level 0: If you are experiencing misread of poor-printed or out-of-spec. bar code in level1, please select level 0.

Level 1: This is the default setting which allows the scanner to operate fastest, while providing sufficient security in decoding "in-spec." Code128 bar codes.





PROGRAM

Symbology Reading Control GS1-128 Setting



F_DEFAULT

Family Code Selection	P.C	Parameter Selection	Option Code
GS1-128 Setting 	SS SS	Disable GS1-128 Enable GS1-128	0 1
GS1-128 Min. Length 	SS MS	Default (01) 01- Maximum Scan 2 digits from the option code chart in Appendix; then FuzzyScan will terminate this selection automatically.	FIN (2 digits)
GS1-128 Max. Length 	SS MS	Default (98) 98-Minimum Scan 2 digits from the option code chart in Appendix; then FuzzyScan will terminate this selection automatically.	FIN (2 digits)





PROGRAM

Symbology Reading Control UK/Plessey Setting



F_DEFAULT

Family Code Selection	P.C	Parameter Selection	Option Code
UK/Plessey Setting 	SS SS SS SS SS SS SS SS	Disable UK/Plessey ◆ Enable UK/Plessey Select UK/Plessey Standard Format ◆ Select UK/Plessey CLSI Format Disable Convert X to A-F ◆ Enable Convert X to A-F Disable check digit transmission ◆ Enable check digit transmission	0 1 2 3 4 5 6 7
UK/Plessey Min. Length 	SS MS	Default (04) ◆ 01-Maximum Scan 2 digits from the option code chart in Appendix, then FuzzyScan will terminate this selection automatically.	FIN (2 digits)
UK/Plessey Max. Length 	SS MS	Default (98) ◆ 98-Minimum Scan 2 digits from the option code chart in Appendix, then FuzzyScan will terminate this selection automatically.	FIN (2 digits)





PROGRAM

Symbology Reading Control Telepen Setting



F_DEFAULT

Family Code Selection	P.C	Parameter Selection	Option Code
Telepen Setting 	SS	Disable Telepen ◆	0
	SS	Enable Telepen	1
	SS	Select Telepen Numeric mode ◆	2
	SS	Select Telepen Full ASCII mode	3
	SS	Disable check digit transmission ◆	4
	SS	Enable check digit transmission	5
Telepen Min. Length 	SS	Default (04) ◆	FIN (2 digits)
	MS	01-Maximum Scan 2 digits from the option code chart in Appendix, then FuzzyScan will terminate this selection automatically.	
Telepen Max. Length 	SS	Default (98) ◆	FIN (2 digits)
	MS	98-Minimum Scan 2 digits from the option code chart in Appendix, then FuzzyScan will terminate this selection automatically.	



PROGRAM

Symbology Reading Control GS1 DataBar Setting



F_DEFAULT

Family Code Selection	P.C	Parameter Selection	Option Code
GS1 DataBar Setting 	SS	Disable GS1 DataBar (RSS-14)	0
	SS	Enable GS1 DataBar (RSS-14) ◆	1
	SS	Disable GS1 DataBar Limited	2
	SS	Enable GS1 DataBar Limited ◆	3
	SS	Disable GS1 DataBar Expanded	4
	SS	Enable GS1 DataBar Expanded ◆	5
GS1 DataBar Limited Security Level 	SS	Level 1	0
	SS	Level 2	1
	SS	Level 3 ◆	2
		Only available for GS1 DataBar Limited Only available for F460, F560 scanners.	
GS1 DataBar Min. Length 	SS	Default (04) ◆	FIN (2 digits)
	MS	01-Maximum Only available for GS1 DataBar Expanded Scan 2 digits from the option code chart in Appendix; then FuzzyScan will terminate this selection automatically.	
GS1 DataBar Max. Length 	SS	Default (74) ◆	FIN (2 digits)
	MS	74-Minimum Only available for GS1 DataBar. Expanded Scan 2 digits from the option code chart in Appendix; then FuzzyScan will terminate this selection automatically.	

▪ **GS1 128 Limited Security Level**

The scanner F460/F560 offers three levels of decode security for GS1 DataBar Limited bar codes:

Level 1: If you failed to read poorly-printed or out-of-spec. bar codes in level 2, please select level 1. This is the most aggressive setting and may increase the misread.

Level 2: If you are experiencing misread of poor-printed or out-of-spec. bar code in level 3, please select level 2.

Level 3: This is the default setting which allows the scanner to operate fastest, while providing sufficient security in decoding "in-spec." GS1 128 Limited" bar codes.





PROGRAM

Symbology Reading Control Composite Codes, Codablock F, PDF417/MicroPDF417 Setting



F_DEFAULT

Family Code Selection	P.C	Parameter Selection	Option Code
Composite Codes Setting 	SS SS SS SS	Disable composite codes ◆ Enable composite codes UPC Composite Mode: UPC never linked ◆ UPC Composite Mode: UPC always linked If UPC Composite Mode: UPC never linked is selected, UPC barcodes are transmitted whether MicroPDF417 symbol is detected or not. If UPC Composite Mode: UPC always linked is selected, UPC barcodes are only transmitted when the MicroPDF417 is detected.	0 1 2 3
Codablock F Setting 	SS SS	Disable ◆ Enable	0 1
PDF417/Micro PDF417 Setting 	SS SS SS SS	Disable PDF417 Enable PDF417 ◆ Disable MicroPDF417 ◆ Enable MicroPDF417	0 1 2 3



PROGRAM

**Symbology Reading Control
Code 16K & Code 49 Setting**



F_DEFAULT

Family Code Selection	P.C	Parameter Selection	Option Code
Code 16K Setting 	SS SS	Disable Code 16K ◆ Enable Code 16K	0 1
Code 16K Min. Length 	SS MS	Default (01) ◆ 01-Maximum Scan 3 digits from the option code chart in Appendix; then FuzzyScan will terminate this selection automatically.	FIN (3 digits)
Code 16K Max. Length 	SS MS	Default (160) ◆ 160-Minimum Scan 3 digits from the option code chart in Appendix; then FuzzyScan will terminate this selection automatically.	FIN (3 digits)
Code 49 Setting 	SS SS	Disable Code 49 ◆ Enable Code 49	0 1
Code 49 Min. Length 	SS MS	Default (01) ◆ 01-Maximum Scan 2 digits from the option code chart in Appendix; then FuzzyScan will terminate this selection automatically.	FIN (2 digits)
Code 49 Max. Length 	SS MS	Default (81) ◆ 81-Minimum Scan 2 digits from the option code chart in Appendix; then FuzzyScan will terminate this selection automatically.	FIN (2 digits)





PROGRAM

Symbology Reading Control QR Code Setting



F_DEFAULT

Family Code Selection	P.C	Parameter Selection	Option Code
QR Code Setting 	SS	Disable QR Code	0
	SS	Enable QR Code ◆	1
		Disable MicroQR Code	2
		Enable MicroQR Code ◆	3
		Disable QR Code Append	4
		Enable QR Code Append ◆	5
		Disable QR Code Inverse Reading	6
		Enable QR Code Inverse Reading	7
		Auto detect QR Code Inverse Reading ◆	8
QR Code Min. Length 	SS	Default (01) ◆	FIN (4 digits)
	MS	01-Maximum Scan 4 digits from the option code chart in Appendix; then FuzzyScan will terminate this selection automatically.	
QR Code Max. Length 	SS	Default (7089) ◆	FIN (4 digits)
	MS	7089-Minimum Scan 4 digits from the option code chart in Appendix; then FuzzyScan will terminate this selection automatically.	



PROGRAM

Symbology Reading Control Data Matrix Setting



F_DEFAULT

Family Code Selection	P.C	Parameter Selection	Option Code
Data Matrix Setting 	SS	Disable Data Matrix	0
	SS	Enable Data Matrix ◆	1
	SS	Disable Data Matrix Inverse Reading	4
	SS	Enable Data Matrix Inverse Reading	5
	SS	Auto Detect Data Matrix Inverse Reading ◆	6
	SS	Disable Data Matrix Mirror Images	7
	SS	Enable Data Matrix Mirror Images	8
	SS	Auto Detect Data Matrix Mirror Images ◆	9
Data Matrix Min. Length 	SS	Default (01) ◆	FIN (4 digits)
	MS	01-Maximum Scan 4 digits from the option code chart in Appendix; then FuzzyScan will terminate this selection automatically.	
Data Matrix Max. Length 	SS	Default (3116) ◆	FIN (4 digits)
	MS	3116-Minimum Scan 4 digits from the option code chart in Appendix; then FuzzyScan will terminate this selection automatically.	
Small DM Code Reading 	SS	Standard ◆	0
	SS	Level 1	1
	SS	Level 2	2

- **Small DM Code Reading:**
When small DataMatrix code can't be read by 2D scanner, you can select "Level 1" or "Level 2" to improve the scanner's ability to read small DataMatrix code. The scanner's snappiness decreased when you select "Level 1" or "Level 2". The higher level will take longer time to read the small DataMatrix barcode.
- **Small DM Code Reading:**
Available firmware: A780 / A680 1.00.01 and above
A770 1.00.24 and above; 2.00.08 and above
A670 1.00.05 and above





PROGRAM

Symbology Reading Control MaxiCode Setting



F_DEFAULT

Family Code Selection	P.C	Parameter Selection	Option Code
MaxiCode Setting 	SS SS	Disable MaxiCode ◆ Enable MaxiCode	0 1
MaxiCode Min. Length 	SS MS	Default (01) ◆ 01-Maximum Scan 3 digits from the option code chart in Appendix, then FuzzyScan will terminate this selection automatically.	FIN (3 digits)
MaxiCode Max. Length 	SS MS	Default (150) ◆ 150-Minimum Scan 3 digits from the option code chart in Appendix, then FuzzyScan will terminate this selection automatically.	FIN (3 digits)





PROGRAM

Symbology Reading Control Aztec Code Setting



F_DEFAULT

Family Code Selection	P.C	Parameter Selection	Option Code
Aztec Code Setting 	SS SS	Disable Aztec Code Enable Aztec Code ◆	0 1
Aztec Code Min. Length 	SS MS	Default (01) ◆ 01-Maximum Scan 4 digits from the option code chart in Appendix; then FuzzyScan will terminate this selection automatically.	FIN (4 digits)
Aztec Code Max. Length 	SS MS	Default (3832) ◆ 3832-Minimum Scan 4 digits from the option code chart in Appendix; then FuzzyScan will terminate this selection automatically.	FIN (4 digits)



PROGRAM

Symbology Reading Control

Australian Post, US Planet, US Postnet, British Post, & Japan Post Setting



F_DEFAULT

Family Code Selection	P.C	Parameter Selection	Option Code
Australian Post Setting 	SS	Disable Australian Post ◆	0
	SS	Enable Australian Post	1
	SS	Raw format Output ◆	2
	SS	Numeric Encoding Output (N Encoding Table)	3
	SS	Alphanumeric Encoding Output (C Encoding Table)	4
	SS	Auto-discriminate Output (Combination C & N Encoding Table)	5
US Planet Setting 	SS	Disable US Planet ◆	0
	SS	Enable US Planet	1
	SS	Disable Check Digit Transmission ◆	2
	SS	Enable Check Digit Transmission	3
US Postnet Setting 	SS	Disable US Postnet ◆	0
	SS	Enable US Postnet	1
	SS	Disable Check Digit Transmission ◆	2
	SS	Enable Check Digit Transmission	3
British Post Setting 	SS	Disable British Post ◆	0
	SS	Enable British Post	1
	SS	Disable Check Digit Transmission ◆	2
	SS	Enable Check Digit Transmission	3
Japan Post Setting 	SS	Disable Japan Post ◆	0
	SS	Enable Japan Post	1

▪ **Australian Post Setting:** Auto-discriminate output option increase the risk of misread because the encoded data format does not specify the Encoding Table used for encoding.





PROGRAM

Symbology Reading Control Netherlands KIX Code, Intelligent Mail, & KoreaPost Code Setting



F_DEFAULT

Family Code Selection	P.C	Parameter Selection	Option Code
Netherlands KIX Code Setting 	SS SS	Disable Netherlands KIX Code ◆ Enable Netherlands KIX Code	0 1
Intelligent Mail Setting (USPS 4CB/One Code) 	SS SS	Disable Intelligent Mail ◆ Enable Intelligent Mail	0 1
Korea Post Code Setting 	SS SS	Disable ◆ Enable Length fixed in 6 characters.	0 1



PROGRAM

Keyboard Interface Control Keyboard Layout (Language) Setting



F_DEFAULT

Family Code Selection	P.C	Parameter Selection	Option Code
Keyboard Layout 	SS	USA (QWERTY) ◆	00
	SS	France (AZERTY)	01
	SS	Germany (QWERTZ)	02
	SS	United Kingdom - UK (QWERTY)	03
	SS	Canadian French (QWERTY)	04
	SS	Spain (Spanish, QWERTY)	05
	SS	Sweden/Finland (QWERTY)	06
	SS	Portugal (QWERTY)	07
	SS	Norway (QWERTY)	08
	SS	Spain (Latin America, QWERTY)	09
	SS	Italy (QWERTY)	10
	SS	Netherlands (QWERTY)	11
	SS	Denmark (QWERTY)	12
	SS	Belgium (AZERTY)	13
	SS	Switzerland-Germany (QWERTZ)	14
	SS	Iceland (QWERTY)	15
	SS	Japan (DOS/V)	16
SS	Czech (QWERTY)	17	
SS	Universal	99	

Please refer to the **ASCII/HEX Table** listed in the Appendix to determine HEX codes for characters, symbols, and functions to be used as preamble or postamble. To set preamble or postamble as function key output, you must enable the “**Function Key Emulation**” feature as listed in page 47 first

- When Universal Keyboard is selected, ASCII 0x20-0x7E characters are sent as sequence of alt key plus numeric keypad value. This is only valid for Windows OS.

▪ **Keyboard Interface Message String :**

Preamble	Data Length	Prefix Symbol ID	Scanned Data	Suffix Symbol ID	Postamble	Record Suffix
1-15 characters	2-4 digits	1 or 3 characters	Variable length	1 or 3 characters	1-15 characters	1 character



PROGRAM

Keyboard Interface Control

Record Suffix, Preamble, Postamble, FNC1 Symbol Character Transmission



F_DEFAULT

Family Code Selection	P.C	Parameter Selection	Option Code
Record Suffix 	SS SS SS SS SS SS	None RETURN ◆ TAB SPACE ENTER (Numeric Key Pad) User defined character (1 character)	0 1 2 3 4 5, (00-7F)
Preamble 	SS MS	None ◆ 1-15 characters Maximum 15-character input; scan "FIN" to terminate this selection.	FIN [00-7F], [FIN]
Postamble 	SS MS	None ◆ 1-15 characters Maximum 15-character input; scan "FIN" to terminate this selection.	FIN [00-7F], [FIN]
FNC1 Symbol Char. Transmit 	SS SS	Disable Enable ◆	0 1

- **FNC1 Symbol Char. Transmit:** When this function is enabled and the FNC1 is contained in scanned data, the scanner transmits the FNC1 to the host. Chart of the FNC1 is provided in Appendix- Keyboard Function Code Table. When the scanner interface is set to keyboard, the scan code is converted to corresponding key function before it is transmitted.
- The function of "Caps Lock Control" and "Key Pad Emulation" are **only** available for IBM PC/AT, PS/VP, PS/2 series personal computers and compatible machines. While selecting the other host interfaces, these selections don't perform the above functions for you.





PROGRAM

Keyboard Interface Control Caps Lock & Caps Lock Release Control



F_DEFAULT

Family Code Selection	P.C	Parameter Selection	Option Code
Caps Lock Control 	SS	"Caps Lock Off" State ◆	0
	SS	"Caps Lock On" State	1
	SS	Auto Detect (PC/AT, PS/2, Keyboard Replacement and DOS/V Machines only)	2
Caps Lock Release Control 	SS	"Caps Lock On, Caps Off" ◆	0
	SS	"Caps Lock On, Shift Off"	1

- The function of "Caps Lock Control" is **only** available for IBM PC/AT, PS/VP, PS/2 series personal computers and compatible machines. While selecting the other host interfaces, these selections don't perform the above functions for you.
- Please check the **actual** Caps Lock state in use while software application is running. If the Caps Lock state is off, select "Caps Lock Off" state, and then FuzzyScan will perform normal data transmission. If the Caps Lock state is on, select "Caps Lock On" state. Select "Auto Detect", FuzzyScan will perform special transmission handshaking without changing the status of Caps Lock switch.



PROGRAM

Keyboard Interface Control Delay Setting



F_DEFAULT

Family Code Selection	P.C	Parameter Selection	Option Code
Intermessage Delay 	SS MS	None ◆ 1-99 (x5) msec. Scan 2 digits from the option code chart in Appendix; then FuzzyScan will terminate this selection automatically.	FIN (2 digits)
Intercharacter Delay 	SS MS	None ◆ 1-99 (x5) msec. Scan 2 digits from the option code chart in Appendix; then FuzzyScan will terminate this selection automatically.	FIN (2 digits)
Interfunction Delay 	SS MS	None ◆ 1-99 (x5) msec. Scan 2 digits from the option code chart in Appendix; then FuzzyScan will terminate this selection automatically.	FIN (2 digits)

- **Intermessage Delay** is a time delay between messages output by FuzzyScan. Increasing this delay will help host applications process the incoming data on time.
- **Intercharacter Delay** is a time delay between data characters output by FuzzyScan. These two parameters are used to synchronize data communication when : 1) the data transmission speed is too fast, characters may be skipped; 2) multitasking operation system or host computers in a network may slow down the keyboard handling; 3) various notebook or desktop PC systems require different timing parameter settings. Please always add one extra unit as safety margin when adjusting these two parameters.
- **Interfunction Delay** is a time delay of transmission of segments in each message string.



PROGRAM

Keyboard Interface Control

Function Key & Key Pad Emulation, Upper/Lower Case Setting, Dollar Sign Control



F_DEFAULT

Family Code Selection	P.C	Parameter Selection	Option Code
Function Key Emulation 	SS SS SS	Enable Keyboard Function Code Table 1 Output ◆ Enable Keyboard Function Code Table 2 Output (Ctrl-Output) Enable Keyboard Function Code Table 3 Output Refer to Appendix – Keyboard Function Code Table for details. Keyboard Function Code Table 3 is only supported by <i>A Series & PA Series</i> .	0 1 2
Key Pad Emulation 	SS SS	Disable key pad emulation ◆ Enable numeric output as key pad (Num Lock On) output	0 1
Upper/Lower Case 	SS SS SS SS	Normal case (neglect the upper/lower case control) ◆ Inverse case (change all characters output to inverse case) Upper case (force all characters output as upper case) Lower case (force all characters output as lower case)	0 1 2 3
Dollar Sign Control 	SS SS SS SS SS	Dollar sign output as “ \$ ” ◆ Dollar sign output as “ ¥ ” Dollar sign output as “ € ” Dollar sign output as “ £ ” Dollar sign output as “ ¢ ”	0 1 2 3 4

▪ The function of “**Key Pad Emulation**” is **only** available for IBM PC/AT, PS/VP, PS/2 series personal computers and compatible machines. While selecting the other host interfaces, these selections don’t perform the above functions for you.



PROGRAM

Keyboard Interface Control Code Page: Barcode Encoding Format, Keyboard Output



F_DEFAULT

Family Code Selection	P.C	Parameter Selection	Option Code
Barcode Encoding Format 	MS	UTF8	00
		Code page 950	10
		Code page 949	11
		Code page 936	12
		Code page 932	13
		Code page 874	14
		WIN1250	15
		WIN1251	16
		WIN1252 ◆	17
		WIN1253	18
		WIN1254	19
		WIN1255	1a
		WIN1256	1b
		WIN1257	1c
		WIN1258	1d
		ISO 8859-1 Latin 1, Western European	1e
		ISO 8859-2 Latin 2, Central European	1f
		ISO 8859-3 Latin 3, Southern European	20
		ISO 8859-4 Latin 4, Northern European	21
		ISO 8859-5 Cyrillic	22
		ISO 8859-6 Arabic	23
		ISO 8859-7 Greek	24
		ISO 8859-8 Hebrew	25
		ISO 8859-9 Latin 5, Turkish	26
		ISO 8859-10 Latin 6, Nordic	27



		ISO 8859-11 Thai	28
		ISO 8859-13 Latin 7, Baltic	29
		ISO 8859-14 Latin 8, Celtic	2a
		ISO 8859-15 Latin 9	2b
		ISO 8859-16 Latin 10, South-Eastern European	2c
<p>Keyboard Output</p>	MS	MAC Unicode Output	01
		WIN Notepad Unicode Output	02
		WIN Wordpad Unicode Output	03
		Code page 950 Output	10
		Code page 949 Output	11
		Code page 936 Output	12
		Code page 932 Output	13
		Code page 874 Output	14
		WIN1250 Output	15
		WIN1251 Output	16
		WIN1252 Output ◆	17
		WIN1253 Output	18
		WIN1254 Output	19
		Code page 852 Output	30
		Code page 855 Output	31
		Code page 866 Output	32
		Code page 850 Output	33
		Code page 437 Output	34
		Code page 737 Output	35
		Code page 857 Output	36
Code page 862 Output	37		
Code page 720 Output	38		
Code page 775 Output	39		
WIN1255 Output	1a		
WIN1256 Output	1b		
WIN1257 Output	1c		
WIN1258 Output	1d		

- **Corresponding Languages:** Please see Appendix below, “Code Page - Table of Corresponding Languages”.
- **Barcode Encoding Format:** 2D barcodes can be encoded using different code pages. To properly decode the data of a 2D barcode, the scanner must first be set to the corresponding code page of such data. Select UTF8 if the 2D barcode was encoded in Unicode (UTF-8).
- **Keyboard Output:** Different languages use different code pages. For your scanner to properly display the content of a 2D barcode, select the code page that corresponds to the content’s language. Please check your system locale setting in Windows and make sure that it also matches this language.
 - 1) Mac Device Output: If your host is a Mac device, select “MAC Unicode Output” as the scanner’s output setting (the data will be in Unicode). You must also first ensure that your Mac device has the required Unicode Hex Input Setup and is configured for the 16-bit input method. Please see Appendix below, “Code Page - Unicode Hex Input Setup”.
 - 2) WIN Notepad Unicode Output: If your host is a Windows device, you can output the data in Unicode format to Notepad. You must first ensure that your Windows device has the required Unicode Hex Input Setup, and is set to the US English input method. Please see Appendix below, “Code Page - Unicode Hex Input Setup”.
 - 3) WIN WordPad Unicode Output: If your host is a Windows device, you can output the data in Unicode format to WordPad. You must first ensure that your Windows device is set to the US English input method.



PROGRAM

Serial Interface Control

STX/ETX Control, Record Suffix, Preamble, Postamble, FNC1 Symbol Char. Transmission



F_DEFAULT

Family Code Selection	P.C	Parameter Selection	Option Code
STX/ETX Control 	SS SS	Disable STX/ETX transmission ◆ Enable STX/ETX transmission STX/ETX are two characters used to indicate the starting and ending of the total data frame transmitted via serial interface.	0 1
Record Suffix 	SS SS SS SS SS SS	None CR (0DH) ◆ LF (0AH) CRLF (0D0AH) TAB (09H) SPACE (20H)	0 1 2 3 4 5
Preamble 	SS MS	None ◆ 1-15 characters Maximum 15-character input; scan "FIN" to terminate this selection.	FIN [00-7F], [FIN]
Postamble 	SS MS	None ◆ 1-15 characters Maximum 15-character input; scan "FIN" to terminate this selection.	FIN [00-7F], [FIN]
FNC1 Symbol Char. Transmit 	SS SS	Disable Enable ◆ When this function is enabled and the FNC1 is contained in scanned data, the scanner transmits the FNC1 to the host. Chart of the FNC1 is provided in Appendix – Keyboard Function Code Table. When the scanner interface is set to keyboard, the scan code is converted to corresponding key function before it is transmitted	0 1

▪ Serial Interface Message String (RS232, USB COM) :

STX	Preamble	Data Length	Prefix Symbol ID	Scanned Data	Suffix Symbol ID	Postamble	ETX	Record Suffix
1 character	1-15 characters	2-4 digits	1 or 3 characters	Variable length	1 or 3 characters	1-15 characters	1 character	1 character





PROGRAM

Serial Interface Control Delay Setting



F_DEFAULT

Family Code Selection	P.C	Parameter Selection	Option Code
Intermessage Delay 	SS MS	None ◆ 1-99 (x5) msec. Scan 2 digits from the option code chart in Appendix; then FuzzyScan will terminate this selection automatically.	FIN (2 digits)
Intercharacter Delay 	SS MS	None ◆ 1-99 (x5) msec. Scan 2 digits from the option code chart in Appendix; then FuzzyScan will terminate this selection automatically.	FIN (2 digits)
Interfunction Delay 	SS MS	None ◆ 1-99 (x5) msec. Scan 2 digits from the option code chart in Appendix; then FuzzyScan will terminate this selection automatically.	FIN (2 digits)

- **Intermessage Delay** is a time delay between messages output by FuzzyScan. Increasing this delay will help host applications process the incoming data on time.
- **Intercharacter Delay** is a time delay between data characters output by FuzzyScan. These two parameters are used to synchronize data communication when : 1) the data transmission speed is too fast, characters may be skipped; 2) multitasking operation system or host computers in a network may slow down the keyboard handling; 3) various notebook or desktop PC systems require different timing parameter settings. Please always add one extra unit as safety margin when adjusting these two parameters.
- **Interfunction Delay** is a time delay between transmission and reception of each segment of the message string.



PROGRAM

Serial Interface Control Protocol, ACK/NAK Setting



F_DEFAULT

Family Code Selection	P.C	Parameter Selection	Option Code
Handshaking Protocol 	SS SS SS SS	None (free running mode) ◆ RTS/CTS (hardware handshaking) ACK/NAK (software handshaking) Xon/Xoff (software handshaking)	0 1 2 3
NAK Retry Count 	SS SS	3 times ◆ 0~255 times	FIN (3 digits)
ACK Indication 	SS SS SS SS	Disable ACK Time-out Indication Enable ACK Time-out Indication ◆ Disable ACK Indication ◆ Enable ACK Indication	0 1 2 3

- USB COM doesn't support RTS/CTS handshaking protocol.
- When the **ACK/NAK Software Handshaking** option is selected, the FuzzyScan waits for an **ACK** (acknowledge) or **NAK** (not acknowledge) from the host computer after each data transmission. If the NAK is received, FuzzyScan will re-send the data until receiving ACK.'
- **NAK Retry Count**
 After transmitting data, the scanner expects a NAK response from the host up to the preset "Serial Response Time-out". If the scanner doesn't get a response, the scanner will issue an error indication and discard the data. When a NAK is received, the scanner transmits the same data again and waits for either an ACK or NAK. The scanner issues an error indication and discards the data under following two conditions:
 1) After preset NAK retry counts is received within the preset serial response time-out.
 2) If the preset time-out is up but the preset NAK retry counts haven't come to the end.
 The default retry counts are three times. If you program "0 time", the scanner won't resend the data to the host when the scanner receives a NAK. The scanner will discard the data. If you program "255 times", the scanner can receive unlimited NAKs from the host within the pre-set serial response time-out.
 This function is not available for batch mode. When you enable this function in on-line mode, the out-of-range function will be disable automatically.
- **ACK Indication:**
 Disable: There's neither LED nor beeping indication for this setting.
 Enable: There's a specific LED and beeping indication for this setting.



PROGRAM

Serial Interface Control Response Time-out Setting, Baud Rate, Data Frame



F_DEFAULT

Family Code Selection	P.C	Parameter Selection	Option Code		
Serial Response Time-out 	SS	None	3 seconds	0	6
	SS	200 mseconds	4 seconds	1	7
	SS	500 mseconds ◆	5 seconds	2	8
	SS	800 mseconds	8 seconds	3	9
	SS	1 second	10 seconds	4	A
	SS	2 seconds	15 seconds	5	B
Baud Rate (BPS) 	SS	38.4K BPS	2400 BPS	0	4
	SS	19.2K BPS	1200 BPS	1	5
	SS	9600 BPS ◆	57.6K BPS	2	8
	SS	4800 BPS	115.2K BPS	3	9
Data Frame 	SS	8, None, 1 ◆	7, Space, 1	0	8
	SS	8, Odd, 1	7, Mark, 1	1	9
	SS	8, Even, 1	7, None, 2	2	A
	SS	8, Space, 1	7, Odd, 2	3	B
	SS	8, Mark, 1	7, Even, 2	4	C
	SS	8, None, 2	7, Space, 2	5	D
	SS	7, Odd, 1	7, Mark, 2	6	E
	SS	7, Even, 1		7	

- When the **RTS/CTS Hardware Handshaking** option is selected, the **RTS** (request to send) and **CTS** (clear to send) signals will be issued before normal data communication. This option is very helpful to ensure the reliability of data communication.
- The **Serial Response Time-out** is a pre-defined delay time for FuzzyScan to wait for handshaking, acknowledgment or non-acknowledgment from the host computer



PROGRAM

Serial Interface Control
Code Page: Barcode Encoding Format,
Serial Port Output (A & PA Series Only)



F_DEFAULT

Family Code Selection	P.C	Parameter Selection	Option Code
Barcode Encoding Format 		UTF8	00
		Code page 950	10
		Code page 949	11
		Code page 936	12
		Code page 932	13
		Code page 874	14
		WIN1250	15
		WIN1251	16
		WIN1252 ◆	17
		WIN1253	18
		WIN1254	19
		WIN1255	1a
		WIN1256	1b
		WIN1257	1c
		WIN1258	1d
		ISO 8859-1 Latin 1, Western European	1e
		ISO 8859-2 Latin 2, Central European	1f
		ISO 8859-3 Latin 3, Southern European	20
		ISO 8859-4 Latin 4, Northern European	21
		ISO 8859-5 Cyrillic	22
ISO 8859-6 Arabic	23		
ISO 8859-7 Greek	24		
ISO 8859-8 Hebrew	25		
ISO 8859-9 Latin 5, Turkish	26		
ISO 8859-10 Latin 6, Nordic	27		
ISO 8859-11 Thai	28		
ISO 8859-13 Latin 7, Baltic	29		
ISO 8859-14 Latin 8, Celtic	2a		



		ISO 8859-15 Latin 9	2b
		ISO 8859-16 Latin 10, South-Eastern European	2c
<p>Serial Port Output</p>	MS	Raw Data ◆	00
		Unicode (Big Endian)	01
		Unicode (Little Endian)	02
		UTF8	03
		CP950 Output (Big Endian)	10
		CP949 Output (Big Endian)	11
		CP936 Output (Big Endian)	12
		CP932 Output (Big Endian)	13
		CP874 Output	14
		WIN1250 Output	15
		WIN1251 Output	16
		WIN1252 Output	17
		WIN1253 Output	18
		WIN1254 Output	19
		WIN1255 Output	1A
		WIN1256 Output	1B
		WIN1257 Output	1C
		WIN1258 Output	1D
		CP852	30
		CP855	31
		CP866	32
		CP850	33
		CP437	34
		CP737	35
		CP857	36
		CP862	37
		CP720	38
		CP775	39
CP950 Output (Little Endian)	90		
CP949 Output (Little Endian)	91		
CP936 Output (Little Endian)	92		
CP932 Output (Little Endian)	93		

▪ To get multilingual output from the serial output, please choose correct barcode encoding format and also serial port output format.



PROGRAM

**Wand/Laser Emulation Control
(F & L Series)**



F_DEFAULT

**Output Polarity, Signal State,
Narrow/Wide Ratio, Margin & Module Time**

Family Code Selection	P.C	Parameter Selection	Option Code
Output Polarity 	SS SS	High level (5Vdc) on Bar (low level on Space) ◆ Low level (0Vdc) on Bar (high level on Space) Determine the output voltage level for both bar and space.	0 1
Initial Signal State 	SS SS	High Level (5Vdc) ◆ Low Level (0Vdc) Determine the initial state of output voltage level.	0 1
Margin Time 	SS SS SS SS SS	10 msec. 15 msec. 20 msec. ◆ 25 msec. 30 msec.	0 1 2 3 4
Module Time 	SS SS SS SS	Extremely short Short Medium ◆ Long	0 1 2 3
Narrow/Wide Ratio 	SS SS SS	1:2 ◆ 1:2.5 1:3	0 1 2



PROGRAM

Wand/Laser Emulation Control (F & L Series)

Code 39/Code 128 Emulation



F_DEFAULT

Family Code Selection	P.C	Parameter Selection	Option Code
Code 39/Code 128 Emulation 	SS	Disable standard Code 39 emulation ◆	0
	SS	Enable standard Code 39 skip emulation	1
	SS	Enable standard Code 39 replace emulation	2
	SS	Enable Full ASCII Code 39 emulation	3
	SS	Enable Code 128 emulation	4

- **Code 39 Skip** : When this option is selected, all scanned data will be translated as Standard Code 39 wand/laser emulation output. If any lower case characters are read, they will be translated to upper case characters. Any other characters that are not available in Code 39 symbology set will be **skipped**.
- **Code 39 Replace** : Any character not normally available in the standard Code 39 symbology set, will be translated as **Space**.



PROGRAM

Operation Control (F & L Series)



F_DEFAULT

Operation Mode

Family Code Selection	P.C	Parameter Selection	Option Code
Operation Mode 	SS	Low Power mode	0
	SS	Trigger mode ◆	1
	SS	Presentation mode	2
	SS	Alternative mode	3
	SS	Flash mode	4
	SS	Force mode	5
	SS	Toggle mode	6
	SS	Diagnostic mode	7
	SS	Level mode	8

- **Low Power Mode (Low Power Triggering):** The scanner goes into idle state after scanning the bar code. You must press the trigger to wake up the scanner for operation.
- **Trigger Mode (External Triggering):** The scanner goes into standby state after scanning the bar code. You must press the trigger to turn on the light source of the scanner before scanning the bar code.
- **Presentation Mode (Auto Detection):** Presentation mode uses ambient light to detect the bar codes. The light source is off until the scanner detects an image which is similar to a barcode. Then the light source turns on automatically to read the bar code. If the light level in the room is not high enough, Presentation Mode may not work properly. You can choose different level of "Presentation Sensitivity" to meet your application (Please refer to the setting of "Presentation Sensitivity").
- **Alternative Mode (Periodic Power Off):** The scanner keeps the light source of the scanner turned on till the pre-defined light source on time is up. After the scanner turns off the light source, you must press the trigger to turn on the light source again. After each good read, the timer counter of "Light Source on Time" is reset. For you do not have to press the trigger frequently, it is very convenient for multiple scanning.
- **Flash Mode (Pulse Driven Reading):** The scanner flashes the light source of the scanner without using the trigger. If the scanner detects an image which is similar to a bar code, the scanner forces on the light source automatically and scans the bar code. Flash Duty Cycle adjustment can change the frequency of the blinking.
- **Force Mode (Continued Power On):** The light source of the scanner is forced on for continued operation without pressing the trigger switch. This mode is convenient for high speed bar code reading.
- **Toggle Mode (Repeat Reading):** The toggle mode is very similar to the Alternative Mode but without the pre-defined light source on time concern. You must press the trigger to turn on the light source of the scanner to scan. The scanner keeps the light source turned on until you press the trigger again.
- **Diagnostic Mode (Test Reading):** This operation mode is specifically designed for diagnostic purposes. When this operation mode is selected, the light source of the scanner is force on without regard for other programmable parameters, such as reread delay, redundancy, and so forth.
- **Level Mode (Auto Power Off):** When this operation mode is selected, the scanner continues to turn on the light source of the scanner before a good read or pre-defined "Light Source on Time". If the scanner decodes a bar code successfully, it turns off the light source immediately. After the scanner turns off the light source, you must press the trigger to turn on the light source again. If there is no scanning operation performed during the pre-defined light source on time, the scanner enters the idle state after the pre-defined light source on time is up.
- FuzzyScan Laser model only have LED illumination (without laser aiming line) in **Flash/ Force/Toggle/ Diagnostics Modes.**



PROGRAM

Operation Control (F & L Series)



F_DEFAULT

Presentation Control, Scan Rate, Flash Duty, SmartStand Power Off Timeout

Family Code Selection	P.C	Parameter Selection	Option Code
Presentation Control 	SS SS SS	Presentation mode ◆ Flash mode Force mode	0 1 2
Scan Rate Control 	SS SS	Dynamic ◆ Fixed	0 1
Flash Duty Cycle 	SS SS SS SS	1/2 duty cycle ◆ 2/3 duty cycle 3/4 duty cycle 4/5 duty cycle L680/L780 laser imagers don't support this function.	0 1 2 3
SmartStand Power Off Timeout 	SS SS SS	3 mins ◆ 5 mins 10 mins Only available for FuzzyScan Laser model	0 1 2

- **Presentation Control:** When the scanner is placed on SmartStand, the scanner will be switched from hand-held scanning to hands free scanning automatically. Three hands scanning modes are available. You are recommended to use flash mode or force mode while under insufficient ambient light.
- **Scan Rate Control:** The scanner will have better motion tolerance when you select "Fixed" scan rate. It's suitable for application which needs higher motion tolerance on the move. But this may impact to the reading distance.
- The **Flash Duty Cycle** is designed to control the flashing frequency of the light source.
- The **SmartStand Power Off Timeout** is a pre-defined duration for scanner's light source on time when the scanner is placed on SmartStand. While the scanner is placed on SmartStand, the scanning-type will be switched from hand-held scanning to presentation scanning and the light source will be forced on automatically. The light source will be off when the pre-defined duration is up.



PROGRAM

Operation Control (L Series)



F_DEFAULT

LED Illumination Control, Illumination Delay

Family Code Selection	P.C	Parameter Selection	Option Code
LED Illumination Control 	SS	Always on	0
	SS	Intelligent Mode ◆	1
Only available for <i>L Series</i> .			
LED Illumination Delay 	SS	100 ms	0
	SS	150 ms ◆	1
	SS	200 ms	2
	SS	250 ms	3
	SS	300 ms	4
Only available for <i>L Series</i> .			

- LED Illumination Control:** When you enable “always on”, the LED illumination will be always on when you press the trigger. When you enable “intelligent mode”, the scanner will emit the laser aiming line first, the LED illumination will be turned on after the preset LED illumination delay. Intelligent mode is recommended to be used in regular ambient light environment.



PROGRAM

**Operation Control
(F & L Series)**



F_DEFAULT

**Laser Aiming Control,
1D Barcode Reading Direction**

Family Code Selection	P.C	Parameter Selection	Option Code
Laser Aiming Control 	SS Disable SS Enable ◆	Only available for <i>L Series</i> .	0 1
1D Barcode Forward-reading Indication 	SS None ◆ SS "S" MS User defined character(1 character)		0 1 2 [00-7F]
1D Barcode Backward-reading Indication 	SS None SS "X" ◆ MS User defined character(1 character)		0 1 2 [00-7F]
1D Barcode Direction Indication Transmission 	SS Disable ◆ SS Enable prefix direction mark transmission SS Enable suffix direction mark transmission SS Enable both prefix and suffix direction mark transmission		0 1 2 3

▪ **Laser Aiming Control:** You can disable or enable laser aiming line when you scan **PDF barcode**.



PROGRAM

**Operation Control
(A Series)**



F_DEFAULT

**Operation Mode,
Presentation & Illumination Control**

Family Code Selection	P.C	Parameter Selection	Option Code
Operation Mode 	SS	Low Power mode (Low power triggering)	0
	SS	Trigger mode (External triggering) ◆	1
	SS	Presentation mode (Auto detection)	2
	SS	Alternative mode (Periodic power off)	3
	SS	Force mode (Continued power on)	4
	SS	Toggle mode (Repeat reading)	5
	SS	Diagnostic mode (Test reading)	6
	SS	Level mode (Auto power off)	7
	SS	Multiple Read Mode	8
Presentation Control 	SS	Presentation mode ◆	0
	SS	Force mode	1
Illumination Control 	SS	Disable	0
	SS	Enable ◆	1
Presentation Background Lighting 	SS	LEDs Off	0
	SS	LEDs On ◆	1

- **Hand-Held Mode:** Low power mode, Trigger mode, Alternative mode, Toggle mode, Level mode, Multiple read mode
- **Hand-Free Mode:** Presentation mode, Force mode,
- The **Illumination Control** is only available for hand-held mode.
- **Presentation Background Lighting Control:** You can enable or disable presentation background lighting of the scanner according to the ambient light condition in presentation mode. When the ambient light is dim or dark, enabling this is helpful for motion sensing function of the scanner.



PROGRAM

**Operation Control
(A Series)**



F_DEFAULT

**Aiming Control, Delay Aiming Time-out Control,
Decode Aiming Control**

Family Code Selection	P.C	Parameter Selection	Option Code
Aiming Control 	SS	Regular Aiming	0
	SS	Intelligent Aiming ◆	1
	SS	Delay Aiming Control	2
Delay Aiming Time-out Control 	SS	200 ms	0
	SS	400 ms ◆	1
	SS	800 ms	2
	SS	1 sec	3
	SS	1.5 sec.	4
	SS	2 sec.	5
	SS	3 sec.	6
	SS	4 sec.	7
Decode Aiming Control 	SS	Disable in Hand-Held mode	0
	SS	Enable in Hand-Held mode ◆	1
	SS	Disable in Hand-Free mode	2
	SS	Enable in Hand-Free mode ◆	3

- The **Aiming Control** is only available for trigger mode. In Intelligent Aiming, the aiming light is turned on when the scanner is lifted. A trigger pull activates decoding process. After 2 seconds of inactivity, the aiming light will be shut off. Delay Aiming Control allows a delay time for the operator to aim the scanner before the image is taken. During the delay time, the aiming light will be on, but the LED illumination won't be turned on until the delay time is up.
- The **Delay Aiming Time-out Control** is only available for trigger mode. You can use Delay Aiming Time-out Control to set the delay time.





PROGRAM

Operation Control (A Series)



F_DEFAULT

Center Alignment, Unique Barcode Reporting

Family Code Selection	P.C	Parameter Selection	Option Code
Center Alignment 	SS	Disable in Hand-Held Mode ◆	0
	SS	Enable in Hand-Held Mode	1
	SS	Disable in Hand-Free Mode ◆	2
	SS	Enable in Hand-free Mode	3
Unique Barcode Reporting 	SS	Disable ◆	0
	SS	Enable	1

- **Center Alignment:** When this function is enabled, the scanner only decodes barcode(s) around aiming line.
- **Unique Barcode Reporting:** When this function is enabled, the scanner will only output data from each barcode once during a scanning cycle (trigger key pressed and held without release). This prevents the output of repeat data in case a barcode is accidentally read multiple times during the same scanning cycle. For **Multiple Read mode** only.



PROGRAM

Operation Control
(A Series)
Smart Scene



F_DEFAULT

Family Code Selection	P.C	Parameter Selection	Option Code
<p>Smart Scene</p>	SS	Scene 1 ◆	0
	SS	Scene 2	1
	SS	Scene 3	2
	SS	Scene 4	3
	SS	Scene 5	4
	SS	Scene 6	5
	SS	Scene 7	6

▪ **Smart Scene** optimizes the scanner’s motion tolerance, scanning speed and scanning sensitivity in different environments.

Scene 1: This is the default setting. It optimizes the scanner’s motion tolerance, scanning speed and scanning sensitivity in most working environments.

Scene 2: When scanning high-density barcodes, you can set the scanner to “Scene 2” to optimize scanners’ motion tolerance, scanning speed and scanning sensitivity.

Scene 3: Scene 3 is for general retail applications. When scanning common retail barcodes, you can set the scanner to “Scene 3” to optimize scanner’s motion tolerance, scanning speed and scanning sensitivity.

Scene 4: Scene 4 is also for general retail applications. It optimizes the scanner’s sensitivity and speed when scanning common retail barcodes. Moreover, it provides superior reading performance when scanning barcodes from the screens of mobile devices, especially large screens or screens with low brightness.

Scene 5: Scene 5 is application-specific. It optimizes the scanner’s motion tolerance, scanning speed and scanning sensitivity when scanning low PCS (print contrast) barcodes on circuit boards.

Scene 6: Scene 6 is application-specific. It optimizes the scanner’s motion tolerance, scanning speed and scanning sensitivity when scanning barcodes on circuit boards under sufficient ambient light.

Scene 7: Scene 7 is application-specific. It optimizes the scanner’s motion tolerance, scanning speed and scanning sensitivity when scanning barcodes from the screens of mobile devices.



PROGRAM

Operation Control (A Series)

Batch Reading



F_DEFAULT

Family Code Selection	P.C	Parameter Selection	Option Code
<p>Batch Reading</p> 	SS	None ◆ Batch Reading rule input (01-16 rules)	[FIN] [Rules] [FIN]

▪ **Batch Reading:** When this function is enabled, you can scan multiple barcodes one by one continuously upon one trigger event. The scanner reports a good read beep and indication only if all bar codes set by the “Batch Reading Rule” are read. Otherwise, the scanner reports an error beep and indication. The scanned data will be transmitted according to the preset sequence which is defined in “Batch Reading Rule” regardless the scanned order of those barcodes.

- Batch Reading function is only available **Trigger Mode**.
- Batch Reading is not available when **Multiple Read Mode** or **Center Alignment** is turned on.
-

▪ **Batch Reading Rule:**

- To set the Batch Reading rule
 - 1.Scan the **PROGRAM** symbol.
 - 2.Scan the **Batch Reading** symbol (Family Code).
 - 3.Use the **Option Code** to define the preset Batch Reading rule.
 - 4.Scan the **FIN** symbol.
 - 5.Scan the **END** symbol to save your Batch Reading rule.

Note: Scan the **ABORT and END** symbol to exit without saving any Batch Reading rule setting.

- When you scan “None”, the preset Batch Reading Rule will be cancelled.

- Batch Reading Rule Syntax:

[n] [Element 1] FF [Element 2] FF [Element 3] FF ...[Element n] FF

Where **n** is the number of elements in the overall rule. The number of elements is up to 16.**FF** indicates the end of one element.

- Element structure:

[Cino ID Hex value] [Code length] [Character match(es)]

Where:

- **[Cino ID Hex value]**

Length: 2 byte

Please find Cino ID hex value from **Symbology ID Table** in appendix. Locate the Hex value for the symbology and scan the 2 digit hex values from the **Option Code**.

Note: 99 is the universal number, indicating all symbologies.



- **[Code length]**
Length: 4 byte
Specify what length of data output will be acceptable for this symbology. When you calculate the length, you must consider the whole data string which includes the programmed Preamble, Postamble, Scanned Data Length, Prefix/Suffix Symbol ID or AIM ID. Scan the four digit data length from the **Option Code**.
Note: 40 characters is entered as 0040; 9999 is a universal number, indicating all lengths.
- **[Character match]**
Length: 2-8 byte
You can refer to **HEX/ASCII Reference Table** to find the Hex value that represents the character(s) you want to match. Use the **Option Code** to scan the alphanumeric combination that represents the ASCII characters. You can match up to 4 characters which are counted from the start character of the whole **Data String**.
Note: When setting the matched character(s), you must match the content of the whole Data String, including the programmed Preamble, Postamble, Scanned Data Length, Prefix/Suffi Symbol ID OR AIM ID if you had defined. **FF** is the universal character, indicating all characters.
- **Batch Reading rule example**
In this example, you are scanning Code 39, Code 128, and Code 93 bar codes, but you would like to output the data in following sequence:
Code 128 - Code 39 - Code 93



B-CODE39



A-CODE128



C-CODE93

You would set up the Batch Reading rule with the following command line:

```
[PROGRAM] [Batch Reading] [0301999941FF07999942FF09999943FF] [FIN] [END]
```

The breakdown of the command line is shown below:

03	The number of elements in the overall rule
01	Code identifier of Code 128
9999	Code length that must match for Code 128, 9999 = all lengths
41	Start character match for Code 128, 41h = "A"
FF	End of first code
07	Code identifier of Code 39
9999	Code length that must match for Code 39, 9999 = all lengths
42	Start character that must match for Code 39, 42h = "B"
FF	End of second code
09	Code identifier of Code 93
9999	Code length that must match for Code 93, 9999 = all lengths
43	Start character match for Code 93, 43h = "C"
FF	End of third code

To program the previous example using specific lengths, you would have to count the programmed Preamble, Postamble, Scanned Data Length, Prefix/Suffix Symbol ID OR AIM ID if you had defined as part of the length. If you enable the Suffix Symbol ID of symbology, you would add one character to the previous example's length.

You would set up the Batch Reading rule with the following command line:

```
[PROGRAM] [Batch Reading] [0301001041FF070009FF09000943FF] [FIN] [END]
```



The breakdown of the command line is shown below:

- 03 The number of elements in the overall rule
- 01 Code identifier of Code 128
- 0010 Code length that must match for Code 128
 A-CODE128 sample length (9) plus Suffix Symbol ID (1) = 10
- 41 Start character match for Code 128, 41h = "A"
- FF End of first code
- 07 Code identifier of Code 39
- 0009 Code length that must match for Code 39
 B-CODE39 sample length (8) plus Suffix Symbol ID (1) = 9
- FF Universal matched character, indicating all character
 Also indicate end of second code
- 09 Code identifier of Code 93
- 0009 Code length that must match for Code 93
 C-CODE93 sample length (8) plus Suffix Symbol ID (1) = 9
- 43 Start character match for Code 93, 43h = "C"
- FF End of third code

Note: If the [Character match(es)] is set to "FF", the following "FF" which indicated the end of the code was not need to set.

- Structure of **Data String**

STX (RS232/USB COM interface)	Preamble	Scanned Data Length	Prefix Symbol ID Or Prefix AIM Symbol ID	Scanned Data modified by DataWizard	Suffix Symbol ID Or Suffix AIM Symbol ID	Postamble	ETX (RS232/USB COM interface)
1 character	1-15 characters	2-4 digits	1 or 3 characters	Variable length	1 or 3 characters	1-15 characters	1 character



PROGRAM

Operation Control
(All Series)



F_DEFAULT

**Buzzer Tone Adjust,
Power On & Good Read Indicator, Vibrator Control**

Family Code Selection	P.C	Parameter Selection	Option Code
Buzzer Tone Adjust 	SS	Buzzer tone – mute	0
	SS	Buzzer tone – low (Frequency 1.20 kHz)	1
	SS	Buzzer tone – medium (Frequency 2.70 kHz) ◆	2
	SS	Buzzer tone – high (Frequency 2.81 kHz)	3
	SS	Buzzer tone - extremely high (Frequency 2.93 kHz)	4
	SS	Power-on beep ◆	5
	SS	No power-on beep	6
Power On Indicator 	SS	Disable (LED off)	0
	SS	LED steady on ◆	1
	SS	LED flash	2
		F560 series scanner doesn't support this function.	
Good Read Indicator 	SS	Disable	0
	SS	Enable ◆	1
Vibrator Control 	SS	Disable	0
	SS	Enable ◆	1
		Optional function is only available for vibrator model.	

▪ **Buzzer Tone Adjust:**

- Available firmware: A680 / A780 1.00.01 and above
- A770 rev.1.00.26, rev. 2.00.10 and above
- A670 rev 1.00.07 and above
- F680 / L680 rev.2.01.12 and above
- F780 / L780 rev.2.01.12 and above
- F560 rev. 2.01.14 and above



PROGRAM

**Operation Control
(A Series)**

Buzzer Volume



F_DEFAULT

Family Code Selection	P.C	Parameter Selection	Option Code
<p>Buzzer Volume</p>	<p>SS SS SS</p>	<p>Low Medium High ◆</p>	<p>0 1 2</p>

▪ **Buzzer Volume:**

Available firmware: A680 / A780 1.00.01 and above
 A770 rev. 1.00.21, rev. 2.00.04 and above
 A670 rev 1.00.03 and above



PROGRAM

Operation Control
(All Series)



F_DEFAULT

Redundancy & 1D Code Inverse Reading

Family Code Selection	P.C	Parameter Selection	Option Code
<p>Redundancy</p>	SS	None	0
	SS	Level 1 <input checked="" type="checkbox"/>	1
	SS	Level 2	2
	SS	Level 3	3
	SS	Level 4	4
	SS	Level 5	5
To prevent potential miss reading.			
<p>1D Barcode Inverse Reading</p>	SS	Disable <input checked="" type="checkbox"/>	0
	SS	Enable	1

- The **Redundancy** is the number of times the same bar code label has to be decoded before it is transmitted.



PROGRAM

Operation Control
(All Series)



F_DEFAULT

Reread Delay & Good Read Delay Control

Family Code Selection	P.C	Parameter Selection	Option Code
Reread Delay (Double Scan Verification) 	SS	Disable	0
	SS	Immediate time out ◆	1
	SS	Short time out	2
	SS	Medium time out	3
	SS	Long time out	4
	SS	Force verification	5
Good Read Delay 	SS	None ◆	0
	SS	200 msec.	1
	SS	500 msec.	2
	SS	1 sec.	3
	SS	1.5 sec.	4
	SS	2 sec.	5
	SS	3 sec.	6

- The **Reread Delay (Double Scan Verification)** is designed to inhibit FuzzyScan from reading the same bar code label twice in pre-defined short duration. Force Verification will not allow reading of the same bar code twice.
- This **Good Read Delay** is the minimum amount of time before the imager can read another bar code.



PROGRAM

Operation Control
(All Series)



F_DEFAULT

**Light Source On Time, Hands Free Time-out,
Good Read Duration, Time Delay to Low Power Mode**

Family Code Selection	P.C	Parameter Selection	Option Code
Light Source On Time 	SS	Short	0
	SS	Medium	1
	SS	Long ◆	2
	SS	Extremely long	3
Hands Free Time-out 	SS	Short ◆	0
	SS	Medium	1
	SS	Long	2
	SS	Extremely long	3
	SS	Disable	4
Good Read Duration 	SS	Short	0
	SS	Medium ◆	1
	SS	Long	2
	SS	Extremely long	3
	SS	Extremely short	4
Time Delay to Low Power Mode 	SS	1 sec	0
	SS	3 sec	1
	SS	5 sec	2
	SS	7 sec	3
	SS	9 sec	4
	SS	Immediate ◆	5

- The **Light Source On Time** is a pre-defined light source time out counter for Alternative Mode, Presentation Mode and Level Mode. The scanner keeps the light source on till the pre-defined light source on time is up. You can adjust this parameter to meet your own application requirement.
- The Presentation Mode, Force Mode and Flash Mode are referred to as “hands free” mode. The hands free mode will be automatically changed to manual trigger mode when you press the trigger. You can remain the scanner in manual trigger mode by setting the **Hands Free Time-Out**. Once the time-out duration is up (if there’s no any trigger operation), the imager will revert to the original hands free mode.
- The **Time Delay to Low Power Mode** sets the time for scanner to enter low power mode after any scanning activity. This setting is only available for the scanner is in low power mode.



PROGRAM

Operation Control
(All Series)



F_DEFAULT

Presentation Auto-Sense & Sensitivity

Family Code Selection	P.C	Parameter Selection	Option Code
Presentation Auto-sense 	SS	Disable	0
	SS	Enable ◆	1
Presentation Sensitivity 	SS	Level 1	0
	SS	Level 2	1
	SS	Level 3	2
	SS	Level 4	3
	SS	Level 5 ◆	4
	SS	Level 6	5
	SS	Level 7	6

- When enabling the **Presentation Auto-sense**, the scanner can be switched from hand-held and hand-free scanning automatically when working with the SmartStand.
- The **Presentation Sensitivity** is used to configure the sensitivity level when the scanner is set as presentation mode. The higher lever means higher sensitivity for detecting the barcode.







PROGRAM

Condensed DataWizard Preamble, Postamble, Data Length, Symbol ID Transmission



F_DEFAULT

Family Code Selection	P.C	Parameter Selection	Option Code
Preamble 	SS MS	None ◆ 1-15 characters Maximum 15-character input; scan "FIN" to terminate this selection.	FIN [00-7F], [FIN]
Postamble 	SS MS	None ◆ 1-15 characters Maximum 15-character input; scan "FIN" to terminate this selection.	FIN [00-7F], [FIN]
Data Length Transmission 	SS SS	Disable ◆ Enable 2~4 digits data length transmission	0 1
Symbology ID Transmission 	SS SS SS SS SS SS SS	Disable symbology ID transmission ◆ Enable prefix symbology ID transmission Enable suffix symbology ID transmission Enable both prefix and suffix symbology ID transmission Enable prefix AIM symbology ID transmission Enable suffix AIM symbology ID transmission Enable both prefix and suffix AIM symbology ID transmission	0 1 2 3 4 5 6

- **DataWizard** is the most powerful, Artificial-Intelligence based data editing expert system provided specially for the FuzzyScan family bar code readers. Through DataWizard, you can process the scanned data prior the transmissions in many ways as **Insert, Delete, Match, Verify, Replace, Reorganize,** and **Repeat Transmission**. It will help you to arrange the transmission of scanned data to any specific format without software modification.
- Due to the resources concern, **Full-feature DataWizard** is only supported by **PowerTool**. Through the PowerTool, all settings and configurations can be done on-screen on Windows-based operating system.
- A **Condensed Version DataWizard** is provided by each FuzzyScan scanner. Through this menu, the condensed DataWizard can be utilized easily via barcode menu readings.
- Please note that all "**Character**" input should be referred to the **ASCII/HEX Table** listed in Appendix to find matched HEX value.
- If you have any problem to use DataWizard, please refer to following pages for details, as well as consult your local FuzzyScan vendor or our web site for further assistance.



PROGRAM

Condensed DataWizard Data Formatter Setting



F_DEFAULT

Family Code Selection	P.C	Parameter Selection	Option Code	2nd Option Code
Formatter Control 	SS MS MS	Disable ◆ Select one bar code symbology Select all bar code symbologies	FIN (2 digits) 00	automatic termination automatic termination
1st Insertion 	SS DS	Disable ◆ Enable 2-digits identified position; max. 3 insertion characters	FIN (2 digits) position	[1-3 characters], [FIN]
2nd Insertion 	SS DS	Disable ◆ Enable 2-digits identified position; max. 3 insertion characters	FIN (2 digits) position	[1-3 characters], [FIN]
3rd Insertion 	SS DS	Disable ◆ Enable 2-digits identified position; max. 3 insertion characters	FIN (2 digits) position	[1-3 characters], [FIN]
4th Insertion 	SS DS	Disable ◆ Enable 2-digits identified position; max. 3 insertion characters	FIN (2 digits) position	[1-3 characters], [FIN]

- The **Data Formatter** is used to edit the scanned raw data prior to transmitting the data to the host computers or terminals. It allows you to select desired bar code symbologies for formatter control, and provides **Multiple Position Insertion** and **Multiple Character Insertion** (max three characters) in the identified position.
- While the Data Formatter is enabled, it arranges only scanned data without **Preamble**, **Postamble**, **STX**, **ETX**, **Data Length**, **Prefix/Suffix Symbology ID** or **Record Suffix**. All of the above programmable parameters perform the same function depending on your setting.
- Regarding the “**Bar Code Selection**” and “**Position Calculation**” of data formatter, please refer to page 75 for details.
- Please note that all “**Character**” input should be referred to the **ASCII/HEX Table** listed in Appendix to find matched HEX value.



PROGRAM

Condensed DataWizard Data Verifier Setting



F_DEFAULT

Family Code Selection	P.C	Parameter Selection	Option Code	2nd Option Code
Verifier Control 	SS MS MS	Disable ◆ Select one bar code symbology Select all bar code symbologies	FIN (2 digits) 00	automatic termination automatic termination
Identified Data Length 	SS DS	Disable ◆ Enable Determine the identified data length for verification.	FIN (2 digits)	
1st Identified Character 	SS DS	Disable ◆ Enable 2-digits checking position; 1 identified character	FIN (2 digits) position	[00-7F]
2nd Identified Character 	SS DS	Disable ◆ Enable 2-digits checking position; 1 identified character	FIN (2 digits) position	[00-7F]
3rd Identified Character 	SS DS	Disable ◆ Enable 2-digits checking position; 1 identified character	FIN (2 digits) position	[00-7F]

- The **Data Verifier** is used to provide advanced verification for error-free scanning and to work as an **Embedded Data Transmitting Filter**.
- All data must conform to the **Identified Bar Code Symbologies**, **Identified Data Length**, and one to three **Identified Characters** in the checking position. Otherwise, the FuzzyScan will not transmit the data to the host computers or terminals, but will instead issue **3 long beeps** for verification error and **skip** the scanned data.
- The Data Verifier checks only scanned data without **Preamble**, **Postamble**, **STX**, **ETX**, **Data Length**, **Prefix/Suffix Symbology ID** or **Record Suffix**.
- Regarding the “**Bar Code Selection**” and “**Position Calculation**” of **Data Verifier**, please refer to page 75 for details.
- Please note that all “**Character**” input should be referred to the **ASCII/HEX Table** listed in Appendix to find matched HEX value.



PROGRAM

Condensed DataWizard Data Replacer Setting



F_DEFAULT

Family Code Selection	P.C	Parameter Selection	Option Code	2nd Option Code
Replacer Control 	SS MS MS	Disable ◆ Select one bar code symbology Select all bar code symbologies	FIN (2 digits) 00	automatic termination automatic termination
1st Replacement 	SS DS	Disable ◆ Enable 2-digits identified position; 1 replacement character	FIN (2 digits) position	[00-7F]
2nd Replacement 	SS DS	Disable ◆ Enable 2-digits identified position; 1 replacement character	FIN (2 digits) position	[00-7F]
3rd Replacement 	SS DS	Disable ◆ Enable 2-digits identified position; 1 replacement character	FIN (2 digits) position	[00-7F]

- The **Data Replacer** is used to edit the scanned raw data prior to transmitting the data to the host computers or terminals. It allows you to select desired bar code symbologies for replacer control, and provides **Multiple Position Replacement** in the identified position.
- All data must conform to the **Identified Bar Code Symbologies**, and one to three **Identified Characters** in the identified position. While the Data Replacer is enabled, it arranges only scanned data without **Preamble, Postamble, STX, ETX, Data Length, Prefix/Suffix Symbology ID or Record Suffix**.
- Regarding the “**Bar Code Selection**” and “**Position Calculation**” of Data Replacer, please refer to page 75 for details.
- Please note that all “**Character**” input should be referred to the **ASCII/HEX Table** listed in Appendix to find matched HEX value.



PROGRAM

Condensed DataWizard Data Organizer Setting



F_DEFAULT

Family Code Selection	P.C	Parameter Selection	Option Code	2nd Option Code
Organizer Control 	SS MS MS	Disable ◆ Select one bar code symbology Select all bar code symbologies	FIN (2 digits) 00	Automatic termination Automatic termination
1st Organization 	SS DS	Disable ◆ Enable 2-digits identified position; Forward/backward data transmission setting	FIN (2 digits) position direction	0 (Forward) ◆ 1 (Backward)
2nd Organization 	SS DS	Disable ◆ Enable 2-digits identified position; Forward/backward data transmission setting	FIN (2 digits) position direction	0 (Forward) ◆ 1 (Backward)
Include/Exclude Control 	SS DS	Transmitted data excluded the data of identified position ◆ Transmitted data included the data of identified position	0 1	

- The **Data Organizer** is used to edit the scanned raw data prior to transmitting the data to the host computers or terminals. It allows you to select desired bar code symbologies for organizer control, and provides maximum two identified positions to send the data **forward** or **backward**. It also allows you to control the transmitted data **including** or **excluding** the data of identification position. Please refer to the application example listed in page 75 for details.
- While the Data Organizer is enabled, it arranges only scanned data without **Preamble**, **Postamble**, **STX**, **ETX**, **Data Length**, **Prefix/Suffix Symbology ID** or **Record Suffix**.
- Regarding the “**Bar Code Selection**” and “**Position Calculation**” of Data Organizer, please refer to page 75 for details.
- Please note that all “**Character**” input should be referred to the **ASCII/HEX Table**.



Select a Bar Code Symbology

You can select one or all types of bar code symbologies to use Condensed DataWizard for advanced transmission arrangement. If you scan “00” to select all types, the FuzzyScan will arrange all incoming data to meet your pre-defined format. If you want to select only one type bar code, please select one of the option code listed below.

1D Bar Code Symbology			
Code 128	01	Matrix 2 of 5	38
GS1-128	31	Interleaved 2 of 5	48
UPC-A	02	China Postal Code	58
UPC-A with 2 supplement	32	German Postal Code	68
UPC-A with 5 supplement	42	Standard/Industrial 2 of 5	08
UPC-E	03	Code 93	09
UPC-E with 2 supplement	33	Code 11	10
UPC-E with 5 supplement	43	MSI/Plessey	11
EAN-13	04	UK/Plessey	12
EAN-13 with 2 supplement	34	Telepen	13
EAN-13 with 5 supplement	44	GS1 DataBar	14
EAN-8	05	GS1 DataBar Limited	22
EAN-8 with 2 supplement	35	GS1 DataBar Expanded	23
EAN-8 with 5 supplement	45	Composite Codes	24
Codabar/NW-7	06	IATA	15
Code 39	07	Coupon Code	16
Code 32	37	PDF417	17
Trioptic Code 39	47	Micro PDF417	25
		Codablock F	18
		Code 16K	19
		Code 49	20

2D Bar Code Symbology			
QR Code	A0	MaxiCode	A2
MicroQR Code	A0	Aztec Code	A3
DataMatrix	A1	Chinese Sensible Code	A4
GS1 DataMatrix	A5		

Postal Code			
Korea Post Code	21	Japanese Post	B4
Australian Post	B0	KIX Post	B5
British Post	B1	Planet Code	B6
Intelligent Mail barcode	B3	Postnet	B8

Position Calculation

[Data Formatter]

If there is a 5-character input data string, refer to the following to calculate the actual position for insertion:

	X		X		X		X		X
00		01		02		03		04	05

[Data Verifier, Data Replacer, Data Organizer]

If there is a 11-character data string, please refer to the following to calculate the actual position for identification.

X	X	X	X	X	X	X	X	X	X	X
00	01	02	03	04	05	06	07	08	09	10

Application Example

If your bar code label is a 16-digit Interleaved 2 of 5 which includes the information of 6-digit date code, 6-digit serial number and 4-digit unit price, you want the FuzzyScan do the following for you without software modification:

- Apply only Interleaved 2 of 5 to the condensed DataWizard.
- Check bar code is actually with 16-digit length.
- Allow bar code output whose date code is leading with "9".
- Three outputs with "TAB" suffix.
- The date code output should skip "9" and replaced it by "A".
- The serial number output should be led with "SN".
- The unit price output should be skipped the first 2 digits.
- Test Bar Code : 9 8 1 0 2 5 1 2 3 4 5 6 9 8 7 6
- Actual Output : **A81025[TAB]SN123456[TAB]76[TAB]**

Programming Procedure

[Data Verifier]

- Scan "Program" to enter the programming mode.
- Scan "Verifier Control" and set bar code symbology to "48" (Interleaved 2 of 5).
- Scan "Identified Data Length" and set the length to "16".
- Scan "1st Identified Character" and set the identified position to "00", then set the identified character to "39" (Hex Code of 9).

[Data Formatter]

- Scan "Formatter Control" and set bar code symbology to "48".
- Scan "1st Insertion" and set the identified position to "06", then inserted characters to "09" (Hex Code of TAB), "53" (Hex Code of S), "4E" (Hex Code of N).
- Scan "2nd Insertion" and set the identified position to "12", then inserted character to "09". In the final, you must scan "FIN" (Finish) code to terminate this selection.
- Scan "3rd Insertion" and set the identified position to "16", then inserted character to "09". In the final, you must scan "FIN" (Finish) code to terminate this selection.

[Data Replacer]

- Scan “Replacer Control” and set bar code symbology to “48”.
- Scan “1st Replacement” and set the identified position to “00”, then replaced character to “41” (Hex Code of A).

[Data Organizer]

- Scan “Organizer Control” and set bar code symbology to “48”.
- Scan “1st Organization” and set the identified position to “16”, then set the data transmission to “0” (forward).
- Scan “2nd Organization” and set the identified position to “17”, then set the data transmission to “1” (backward).
- Scan “END” (Exit) to terminate the programming.

[Important Notice]

Please note that Condensed DataWizard will follow the preset working flow as below:

Verifier » Formatter » Replacer » Organizer

So when you set the identified position in Data Organizer, you must consider the inserted data which you already set via Data Formatter.

APPENDIX

Symbology ID Table

Each AIM Code Identifier contains the three-character string **Jcm** where:

J = Flag Character; **c** = Code Character; **m** = Modifier Character

1D Symbology ID Table												
Code Family	Primary Format	Cino ID		AIM ID		Code Family	Primary Format	Cino ID		AIM ID		
		Hex Value	Char.	Code Char.	Modified Char.			Hex Value	Char.	Code Char.	Modified Char.	
UPC	UPC-A	2	A	E	0	EAN/JAN	EAN/JAN-8	05	N	E	4	
	UPC-A with 2 suppl.	32			1		EAN/JAN-8 with 2 suppl.	35			1	
	UPC-A with 5 suppl.	42			2		EAN/JAN-8 with 5 suppl.	45			2	
	UPC-E	3	E		0		EAN/JAN-13	04	F	E	0	
	UPC-E with 2 suppl.	33			1		EAN/JAN-13 with 2 suppl.	34			1	
	UPC-E with 5 suppl.	43			2		EAN/JAN-13 with 5 suppl.	44			2	
	Example: A UPC-A bar code 012345678950 with 2 supplement 12 is transmitted as J E0012345678950 J E112						Example: A EAN/JAN-8 bar code 49123562 with 5 supplement 12345 is transmitted as J E449123562 J E212345					
Code 128	Code 128	01	B	C	m	Code 93	Code 93	09	H	G	m	
	GS1-128	31	C		1	Code 11	Code 11	10	P	H	m	
Codabar	Codabar/NW-7	06	D	F	m	MSI/Plessey	MSI/Plessey	11	R	M	m	
Code 25	Standard/Industrial 2 of 5	08	I	S	0	UK/Plessey	UK/Plessey	12	S	P	0	
	Matrix 2 of 5	38	K	X	0	Telepen	Telepen	13	T	B	m	
	Interleaved 2 of 5	48	J	I	m	GS1 DataBar	GS1 Databar	14	X	e	m	
							GS1 DataBar Limited	22				
							GS1 DataBar Expanded	23				
	China Postal Code	58	L	X	0	Composite	Composite Code	24				
German Postal Code	68	M	I	m	Code 39	Code 39	07	G	A	m		
						Code 39 Trioptic	47	W	X	0		
IATA	IATA	15	O	R	m		Code 32	37	G	A	0	
UCC Coupon	UCC Coupon Code	Z				PDF417	PDF417	17	V	L	m	
						Micro PDF417	25					
	Example : A UPC-A 512345678900 + GS1-128 81010123451297 bar code is transmitted as J E0512345678900 J C181010123451297						Codablock	Codablock F	18	Y	O	m
	Example: A EAN-13 9923456789019 + GS1-128 81010123451297 bar code is transmitted as J E09923456789019 J C181010123451297						Korea Post	Korea Post Code	21	a	X	0
Remark: Above examples are given for the transmission of AIM ID.												

2D Symbology ID Table											
Code Family	Primary Format	Cino ID		AIM ID		Code Family	Primary Format	Cino ID		AIM ID	
		Hex Value	Char.	Code Char.	Modified Char.			Hex Value	Char.	Code Char.	Modified Char.
QR Code	QR Code	A0	b	Q	m	British Post	British Post	B1	h	X	0
Micro QR Code	Micro QR Code					Intelligent Mail barcode	Intelligent Mail barcode	B3	j		0
Data Matrix	Data Matrix	A1	c	d	m	Japanese Post	Japanese Post	B4	k		0
	GS1 Data Matrix	A5									0
MaxiCode	MaxiCode	A2	d	U	m	KIX Post	KIX Post	B5	l		0
Aztec Code	Aztec Code	A3	e	z	m	Planet Code	Planet Code	B6	m		0
Chinese Sensible	Chinese Sensible	A4	f	X	0	Postnet	Postnet	B8	o		0
Australian Post	Australian Post	B0	g		0						

Keyboard Function Code Table

No.	ANSI	ASCII	Key Function 1	Key Function 2	Key Function 3*
00	NUL	00H	RESERVED	Ctrl + @	CTRL MAKE (Left)
01	SOH	01H	CTRL (Left)	Ctrl + A	CTRL BREAK (Left)
02	STX	02H	ALT (Left)	Ctrl + B	ALT MAKE (Left)
03	ETX	03H	SHIFT	Ctrl + C	ALT BREAK (Left)
04	EOT	04H	CAPS LOCK	Ctrl + D	CAPS LOCK
05	ENQ	05H	NUM LOCK	Ctrl + E	NUM LOCK
06	ACK	06H	ESC	Ctrl + F	ESC
07	BEL	07H	F1	Ctrl + G	F1
08	BS	08H	BACK SPACE	Ctrl + H	BACK SPACE
09	HT	09H	TAB	Ctrl + I	TAB
10	LF	0AH	F2	Ctrl + J	F2
11	VT	0BH	F3	Ctrl + K	F3
12	FF	0CH	F4	Ctrl + L	F4
13	CR	0DH	ENTER (CR)	Ctrl + M	ENTER (CR)
14	SO	0EH	F5	Ctrl + N	F5
15	SI	0FH	F6	Ctrl + O	F6
16	DLE	10H	F7	Ctrl + P	F7
17	DC1	11H	F8	Ctrl + Q	F8
18	DC2	12H	F9	Ctrl + R	F9
19	DC3	13H	F10	Ctrl + S	F10

▪ The **Key Function Table 3** is only supported by *A series* and *PA series*.

No.	ANSI	ASCII	Key Function 1	Key Function 2	Key Function 3
20	DC4	14H	F11	Ctrl + T	WIN MAKE (Left)
21	NAK	15H	F12	Ctrl + U	WIN BREAK (Left)
22	SYN	16H	INS (Insert) (Edit)	Ctrl + V	SHIFT MAKE (Left)
23	ETB	17H	DEL (Delete) (Edit)	Ctrl + W	SHIFT BREAK (Left)
24	CAN	18H	HOME (Edit)	Ctrl + X	HOME (Edit)
25	EM	19H	END (Edit)	Ctrl + Y	END (Edit)
26	SUB	1AH	PAGE UP (Edit)	Ctrl + Z	PAGE UP (Edit)
27	ESC	1BH	PAGE DOWN (Edit)	Ctrl + [PAGE DOWN (Edit)
28	FS	1CH	UP (Edit)	Ctrl + \	UP (Edit)
29	GS	1DH	DOWN (Edit)	Ctrl +]	DOWN (Edit)
30	RS	1EH	LEFT (Edit)	Ctrl + 6	LEFT (Edit)
31	US	1FH	RIGHT (Edit)	*see below note	RIGHT (Edit)

▪ The **Key Function Table 3** is only supported by *A series* and *PA series*.

 To emulate the keyboard function key input for user definable parameters, user must configure actual content using the **Reserved ASCII 00 – 31** characters, and also **Enable** the “Function Key Emulation”. Otherwise, the Ctrl output will be done by the scanner. Please refer to the above Keyboard Function Code Table which is for IBM PC/XT/AT, PS/2, PS/VP, COMPAQ PC, HP Vectra PC, Notebook PC, APPLE and PowerMac, and WYSE PC Enhanced or fully compatible machines.

 The last character in the Ctrl Output column is varied for different countries.

Country (refer to Keyboard Layout) & Character					
United State	-	Switzerland	-	France	=
Belgium	-	UK	-	Germany	-
Sweden	-	Denmark	-	Norway	-
Spain	-	Italy	-		

Code Page - Table of Corresponding Languages

Description	Code Page	Description	Code Page
Albanian	850	Hungarian	852
Arabic	1256	Icelandic	850
Arabic	720	Italian	850
Baltic	1257	Japanese	932
Bulgarian	866	Korean	949
Catalan	850	Latin 1	1252
Croatian	852	Latin 2	1250
Cyrillic	1251	Latin 5	1254
Czech	852	Latin American	850
Danish	850	Latvian	775
Dutch	850	Lithuanian	775
Estonian	775	Norwegian	850
English - United Kingdom	850	Polish	852
English - Australia	850	Portuguese	850
English - Canada	850	Romanian	852
English - New Zealand	850	Russian	866
English - United States	437	Serbian	855
English - South Africa	437	Slovakian	852
English - Philippines	437	Slovenian	852
Finnish	850	Spanish	850
French	850	Swedish	850
German	850	Chinese (Tradition)	950
Greece	737	Chinese (Simple)	936
Greece	1253	Thai	874
Hebrew - write	1255	Turkish	857
Hebrew Israel	862	Vietnamese	1258

Code Page - Unicode Hex Input Setup

1. Windows - Setting up the Windows Registry

Step 1: Open the Registry Editor. You can do so by typing “regedit” in the “Search Windows” function or in Command Prompt.

Step 2: Go to HKEY_CURRENT_USER\Control Panel\Input Method

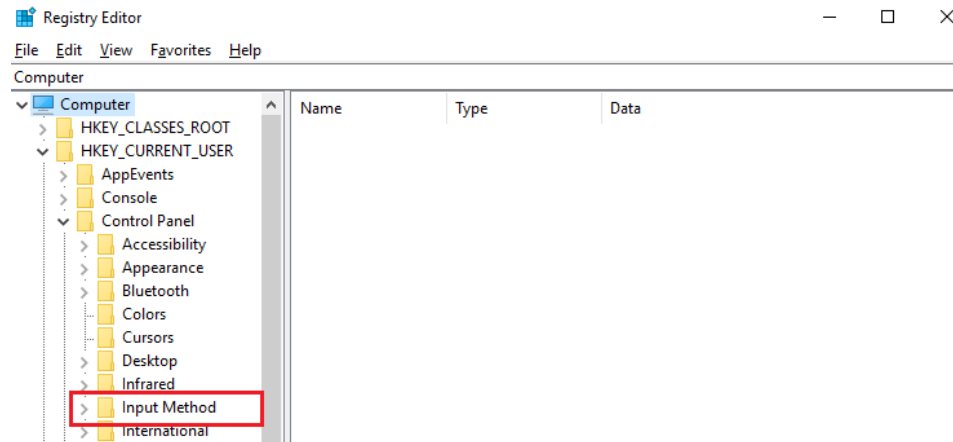

Step 3: Right-click on mouse or press shift + F10 (on keyboard) to add a new String Value (of type “REG_SZ”).

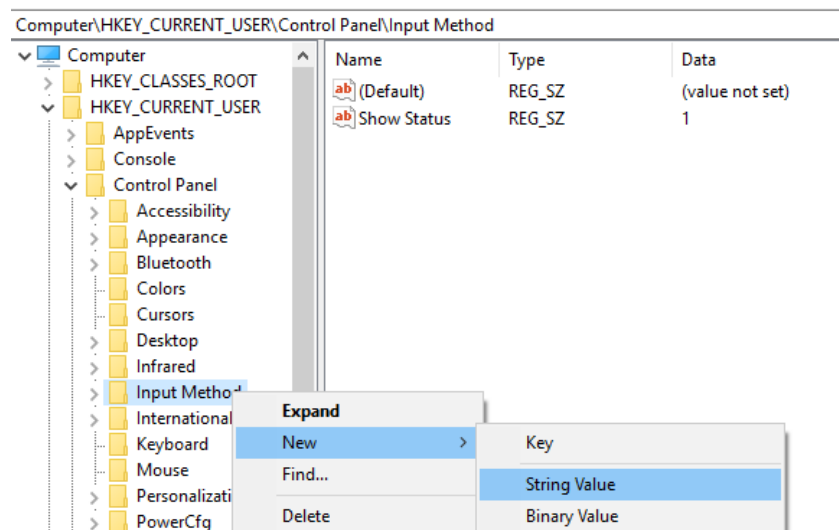

Step 4: Name the new String value as “EnableHexNumpad” and set its Value data to “1”.

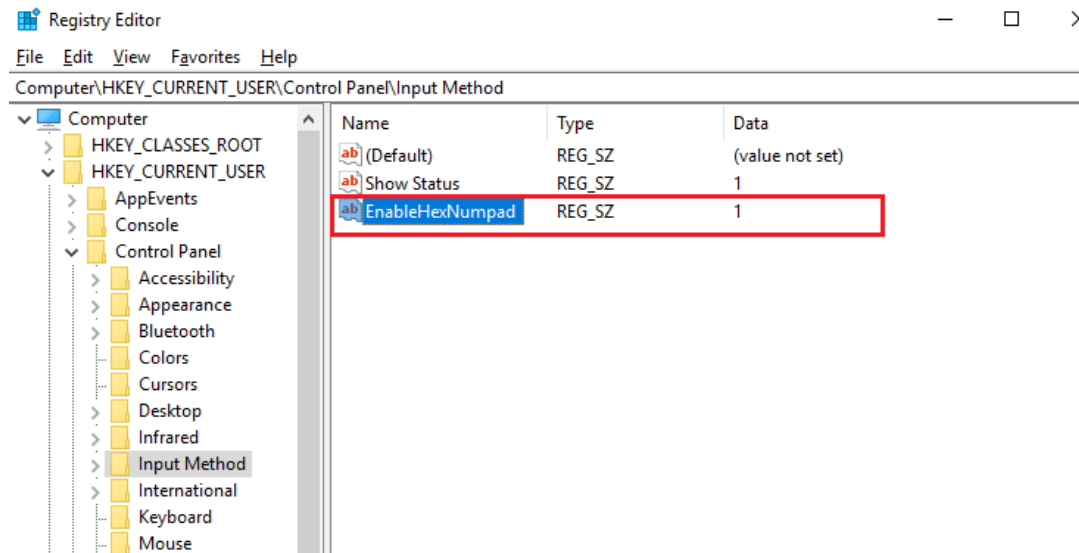

Step 5: Reboot the computer.

2. MAC - Adding Unicode Hex Input in menu bar

Step 1: Go to the Apple Menu -> System Preferences -> Keyboard

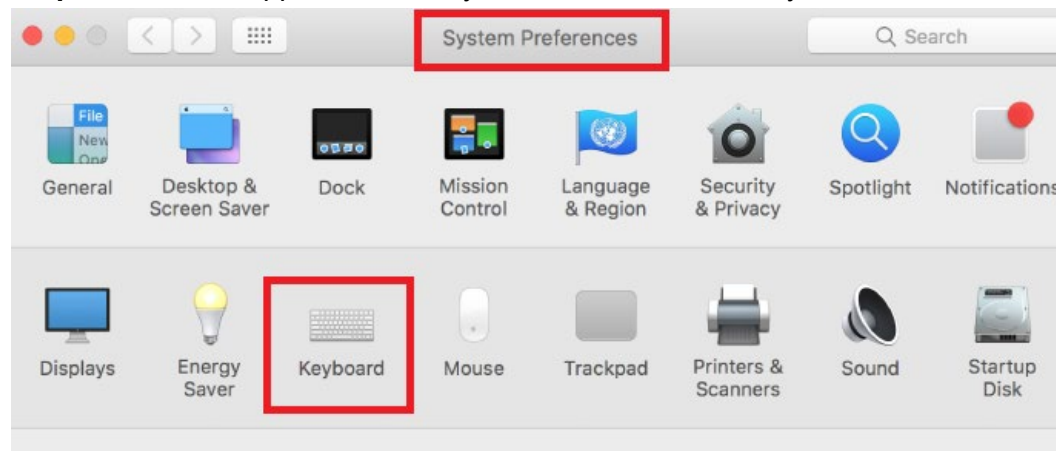

Step 2: On the Keyboard tab, click on “Input Sources” and check the “Show Input menu in menu bar” box.

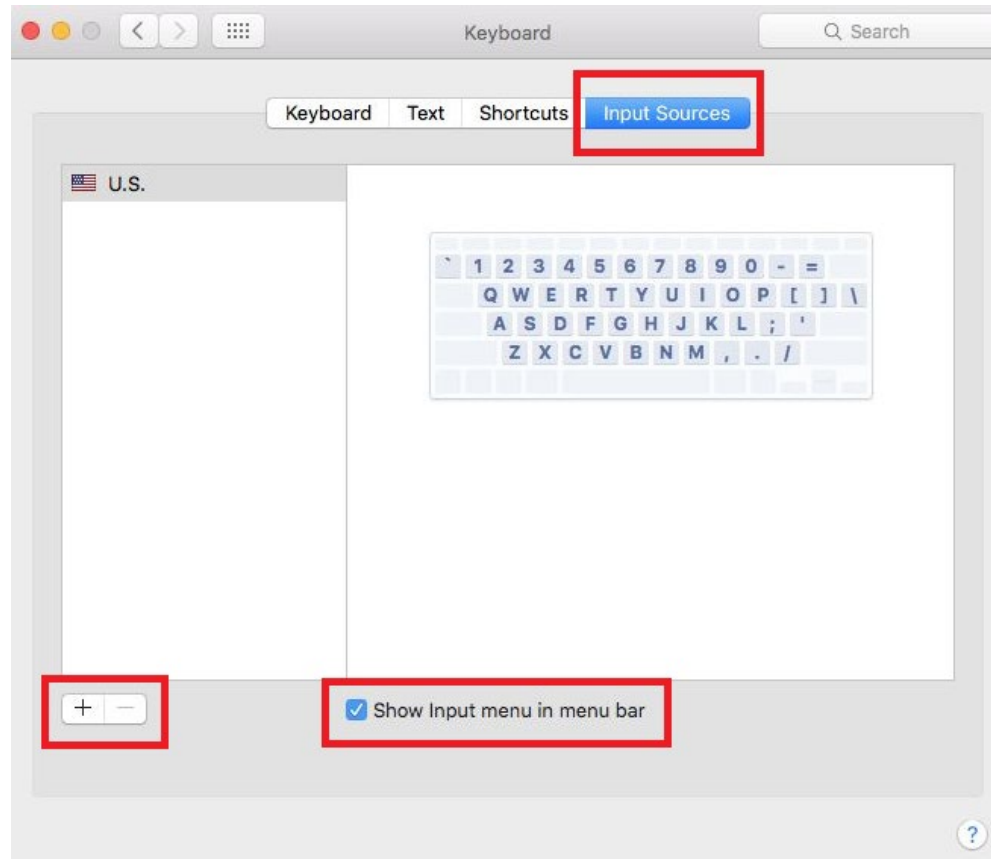

Step 3: Click the “+” button to add an input source.

Step 4: Scroll to and select “Others”. Click on “Unicode Hex Input” (you can also use the Search function to find it). When done, click on the “Add” button.

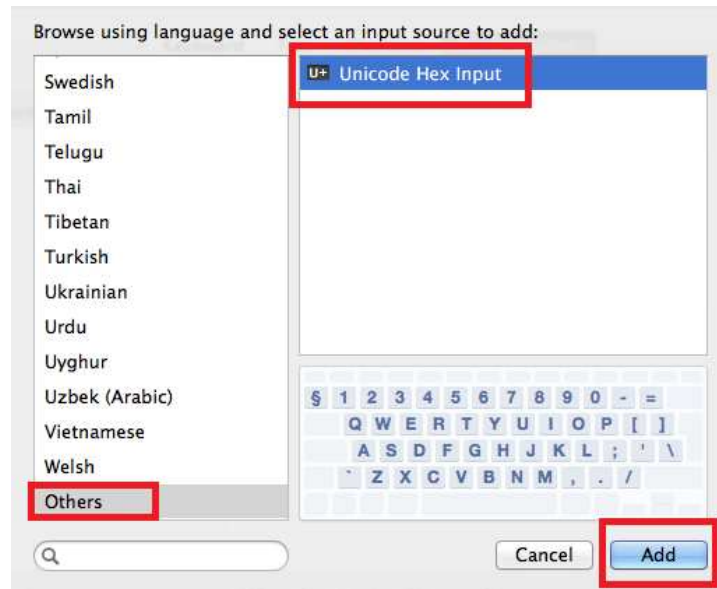

Step 5: Close the Keyboard Preferences menu.

Step 6: Change the input selection to Unicode Hex Input in menu bar.



ASCII Input Shortcut

To configure the user definable parameters of FuzzyScan via programming menu, FuzzyScan will ask you to scan your desired ASCII value in **HEX** form. You have to refer to the “**HEX/ASCII Table**” for details.

Example:

If you want the scanned data output leading with a Dollar Sign, you have to set the “Preamble” to “\$”. The configuration procedure is listed below for reference.

- Scan the system command – **PROGRAM** listed on page 3-24 to enter programming mode.
- Scan family code – **PREAMBLE** to select this family.
- Refer to the **Hex/ASCII Table**, you will find the HEX value of “\$” is **24**.
- Scan the option code – **2** listed on the fold out back cover.
- Scan the option code – **4** listed on the fold out back cover.
- Scan the system command – **FIN (Finish)** to terminate Preamble setting.
- Scan the system command – **End** to exit the programming mode for normal operation.

HEX/ASCII Reference Table

H L	0	1	2	3	4	5	6	7
0	NUL	DLE	SPACE	0	@	P	`	p
1	SOH	DC1	!	1	A	Q	a	q
2	STX	DC2	"	2	B	R	b	r
3	ETX	DC3	#	3	C	S	c	s
4	EOT	DC4	\$	4	D	T	d	t
5	ENQ	NAK	%	5	E	U	e	u
6	ACK	SYN	&	6	F	V	f	v
7	BEL	ETB	'	7	G	W	g	w
8	BS	CAN	(8	H	X	h	x
9	HT	EM)	9	I	Y	i	y
A	LF	SUB	*	:	J	Z	j	z
B	VT	ESC	+	;	K	[k	{
C	FF	FS	,	<	L	\	l	
D	CR	GS	-	=	M]	m	}
E	SO	RS	.	>	N	^	n	~
F	SI	US	/	?	O	_	o	DEL

 Example : ASCII “A” → HEX “41”; ASCII “a” → “61”

 : High Byte of HEX Value

 : Low Byte of HEX Value

Host Interface Quick Set Commands



RS232 Serial



Keyboard Replacement



USB HID Legacy Mode



◆USB HID Standard Mode



USB HID Turbo Mode



PS/2 (DOS/V) KBW Standard Mode



PS/2 (DOS/V) KBW Turbo Mode



USB Com Port Emulation

Operation Mode Quick Set Commands (*F & L Series*)



Low Power (Low power trigger)



Force (Continued power on)



Alternative (Periodic power off)



◆ Trigger (External triggering)



Toggle (Repeat reading)



Presentation (Auto sensing)



Flash (Pulse driven reading)



Diagnostic (Test reading)



Level (Auto power off)

Operation Mode Quick Set Commands (*A Series*)



Low Power (Low power trigger)



Force (Continued power on)



Alternative (Periodic power off)



◆Trigger (External triggering)

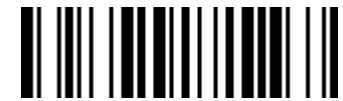

Toggle (Repeat reading)



Presentation (Auto sensing)

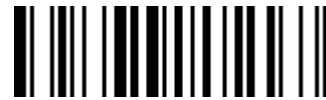

Level (Auto power off)

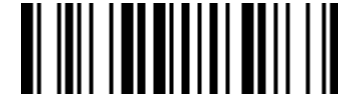

Diagnostic (Test reading)



Multiple Read

Option Codes



0



1



2



3



4



5



6



7



8



9



A



B



C



D



E



F



FIN (Finish)



Abort



END (Exit)

System Commands



PROGRAM
(Enter Programming Mode)



FIN (Finish)



END
(Exit Programming Mode)



Save User Default



User Default



System Information List
(SYSLIST)



PowerTool Host Link



Factory Default



Master Default

- **Factory Default:** After scanning "Factory Default" command, all parameters will be returned to factory default value.
- **Master Default:** After scanning "Master Default" command, the scanner will remain the pre-set parameters of **Host Interface Selection**, **Keyboard Interface Control** (except Record Suffix; Preamble; Postamble), **Serial Interface Control** (except Record Suffix; Preamble; Postamble), and **Wand/Laser Emulation Control**, the rest of parameters will be returned to default value.
- **User Default:** After scanning "Save User Default" command, all current parameters will be stored to the flash memory. Once you change the parameter and would like to return to previous setting, please scan "User Default".



www.cino.com.tw

FuzzyScan Family Programming Manual

CINO GROUP

PC WORTH INT'L CO., LTD.

cino