



WideTEK® 36CL/48CL/60CL



Setup Instructions English

11/2018

Contents

Information about the Instructions and the Manufacturer	4
Keep Instructions with the Scanner	4
Design Features in Text.....	5
Design Features in Pictures.....	5
Associated Documents	6
Copyright	6
Contact Data of the Manufacturer in Germany.....	7
Technical Support	7
Contact Data of the Manufacturer in the U.S.	7
Safety.....	8
Intended Use	8
Basic Safety Information.....	8
Avoiding Property Damage and Malfunctions.....	10
Responsibility of the Owner	10
Staff Qualifications.....	10
Design Features of Warning Notices	11
Formatting of Information Regarding Property Damage.....	11
Description	12
Purpose and Function	12
WideTEK® 36CL/48CL Overview	12
WideTEK® 60CL Overview.....	13
Rear View	14
Setup Menu Overview Screen	15
Rating Plate.....	16
Prepare for Setup.....	18
Connect the Power Supply	18
Establish the Network Connection	18
Positioning the Scanner on the Optional Floor Stand.....	19
Connect the Optional Monitor	20

Connect the Optional Touchscreen	20
Switch On the Scanner	21
Switch Off the Scanner	23
Perform Setup	25
Change the Menu Language	25
Activate the Setup Menu	27
Perform White Balance - 36CL/48CL	31
Perform White Balance - 60CL	41
Assign the IP Address	52
Modify User Settings	61
Set the Time and Date	68
Perform Test Suite	73
Perform Touchscreen Test	76
Height Adjustment (WT60CL)	80
Recovery	82
Technical Specifications	88
Scanner Specification	88
Ambient Conditions	90
Electrical Specifications	91
Document Specification	91
Dimensions and Weight WideTEK® 36CL-600	92
Dimensions and Weight WideTEK® 48CL-600	92
Dimensions and Weight WideTEK® 60CL-600	93

Information about the Instructions and the Manufacturer

These instructions show you how to safely prepare and perform the setup for the wide format scanners WideTEK® 36CL/48CL/60CL. The WideTEK® 36CL/48CL/60CL scanners are hereinafter referred to as "Scanner".

In these instructions, the start button is called "power button".

Keep Instructions with the Scanner

These instructions are a part of the scanner.

- Please always store these instructions together with the scanner.
- Ensure that the instructions are available for the user.
- Enclose the instructions when you sell the scanner or transfer it in any other way.

Design Features in Text

Many text passages in these instructions have been formatted to indicate specific elements, as illustrated below:

Normal text

BUTTONS OF THE SCREEN PAGE

"Menu names"

- Action steps
- Enumeration of the first level

Cross-references

- ❗ Tips contain additional information, such as special information to prepare for and perform the setup.

Design Features in Pictures

Where a reference is made to elements in a legend or in the text, these are marked with a number (1).

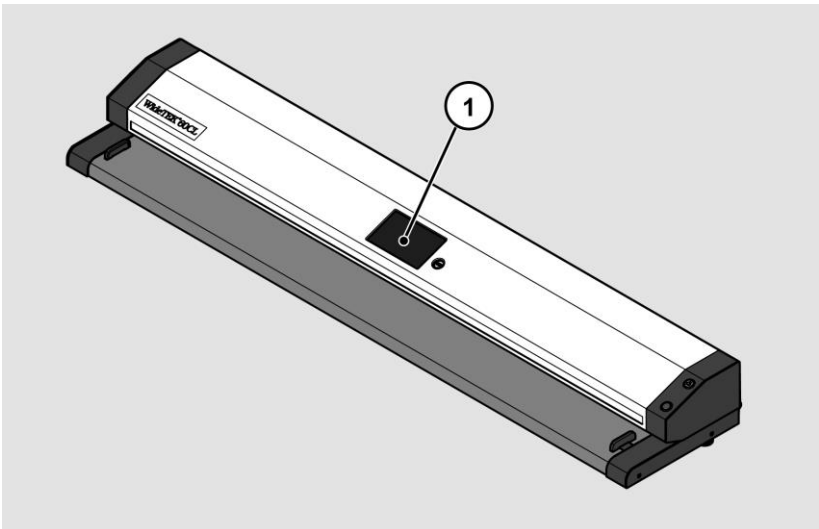

Associated Documents

In addition to these instructions, other documents associated with the operation of the scanner include:

- Unpacking and Repacking Instructions
- Legal Information (Declarations of Conformity, FCC Declaration, Safety & EMI Certificates, RoHS etc.).

Copyright

These instructions contains information that is subject to copyright. These instructions may not be reproduced in any form, printed, filmed, edited, copied or distributed, in whole or in part, without prior written permission from Image Access GmbH.

© Image Access GmbH 2018

All rights reserved.

Trademarks

Scan2Net®, Scan2PAD®, Bookeye® and WideTEK® are registered trademarks of Image Access, all other trademarks are the property of their respective owners.

Contact Data of the Manufacturer in Germany

Image Access GmbH
Hatzfelderstraße 161-163
42281 Wuppertal
Phone: +49-202-27058-0
E-Mail: documentation@imageaccess.de
Internet address: www.imageaccess.de

Technical Support

Image Access technical support can be reached at the e-mail address:
support@imageaccess.de.

Contact Data of the Manufacturer in the U.S.

Image Access LP
2511 Technology Drive, Suite 109
Elgin
IL 60124
Phone: +1-224-293-2585
E-Mail: support@imageaccess.us
Internet address: www.imageaccess.us

Safety

Intended Use

The scanner is used for scanning images and documents. The documents must comply with the characteristics described in the technical specifications. The scanner is designed for use in enclosed spaces in the commercial sector.

Intended use also includes observing and following all information provided in these instructions, especially the safety instructions. Any other use is considered to be improper and will void the warranty and liability claims.

Ambient Conditions

Ensure that the scanner is used exclusively under the following environmental conditions:

- Ambient temperature during operation: +5 °C to +40 °C
 - Storage temperature: 0 °C to +60 °C
 - Relative humidity: 20 to 80%, non-condensing
- Ensure that the scanner is not exposed to direct sunlight.

Basic Safety Information

Avoid Injury or Death by Electric Shock

- Never open the housing of the scanner.
- Do not expose the scanner to dripping or splashing water and do not place any vessel filled with liquid on the scanner. Penetrating liquid can damage the scanner.
- Do not insert objects through existing slots or openings into the interior of the scanner.

- Only connect the scanner with the plug of the supplied AC adapter to a professionally installed and grounded outlet.
- Do not use the AC adapter if the power supply's housing or the cable are damaged. In this case, replace the power supply with a power supply of the same type.
- Do not use the scanner if it is visibly damaged. In this case, unplug the power cord from the wall outlet. Contact Image Access technical support, see section *Technical Support* starting at page 7.

Avoid Burns

- Do not cover the existing openings in the scanner housing. They serve to ventilate. Covering the openings could cause overheating.
- Do not place the scanner in front of air conditioning units, which produce high heat.

Avoid Fractures, Contusions and Bruises

Incorrect installation of the cables can cause tripping.

- Lay the connecting cables so that no one can trip over them.

The scanner weighs between 53 lbs. (24 kg) and 75 lbs. (34 kg).

- Only carry the scanner with a second person.
- Place the scanner only on a stable, level and vibration-free surface that has sufficient strength for the weight of the scanner.

Avoiding Property Damage and Malfunctions

- Ensure adequate ventilation to comply with the environmental conditions.
- Do not place the scanner in the vicinity of devices that emit strong electromagnetic radiation.
- Always place the scanner on a suitable, stable table or the optional floor stand.
- Do not lean on the scanner.
- Ensure that the thickness of the material to be scanned does not exceed 2,5 mm.
- Do not use any cleaning agents containing abrasive additives, solvents or acids. Use a damp microfiber cloth.
- Operate the touchscreen only with your finger. Other objects can damage the touchscreen.

Responsibility of the Owner





The scanner owner must ensure that only qualified personnel carry out the setup of the scanner.

Staff Qualifications



The staff that carries out the setup of the scanner must have knowledge in installing, connecting and putting computer accessories into operation.

Design Features of Warning Notices

In these instructions, the following warning information can be found:

 WARNING	
	Notices with the word WARNING warn about a dangerous situation that could lead to death or serious injuries.
 CAUTION	
	Notices with the word CAUTION warn about a situation that could lead to light or medium-scale injuries.

The following symbols are used in the warnings:

Symbol	Explanation
	Danger from electrical shock
	General danger symbol

Formatting of Information Regarding Property Damage

ATTENTION!	
	These notices warn of situations that can lead to property damage.

Description

Purpose and Function

The scanner is used for scanning images and documents. It is designed for use in enclosed spaces in the commercial sector. Intended use also includes observing and following all instructions in these instructions, especially the safety instructions. Any other use is considered to be improper and will void the warranty and liability claims.

WideTEK® 36CL/48CL Overview

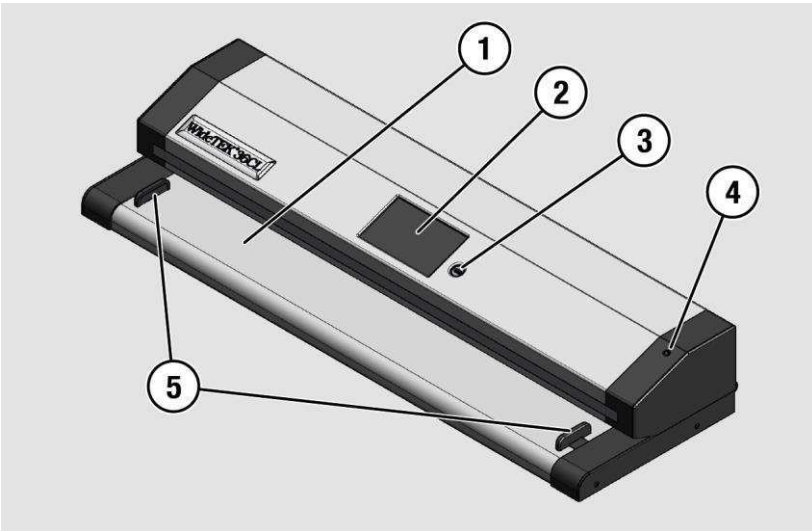

No.	Name
1	Document transport
2	Touchscreen
3	USB connector
4	Power button
5	Transport guides

WideTEK® 60CL Overview

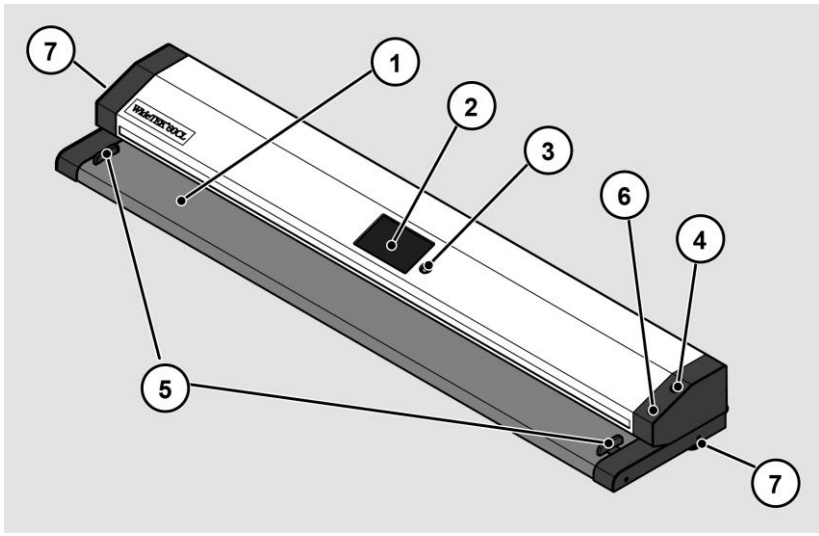

No.	Name
1	Document transport
2	Touchscreen
3	USB connector
4	Power button
5	Transport guides
6	Stop button ¹
7	Height adjustment screws

¹ (for example WideTEK 60CL)

Rear View

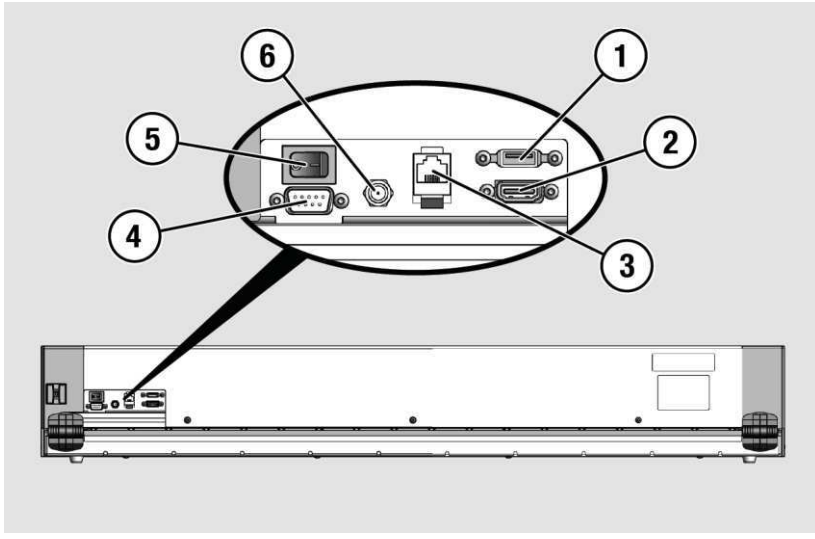

No.	Name
1	USB connector
2	HDMI connector
3	Network connector
4	Recovery key connector ¹
5	Main switch
6	19 V DC connector for external power supply

¹ (for example WideTEK 36CL/48CL)

Setup Menu Overview Screen

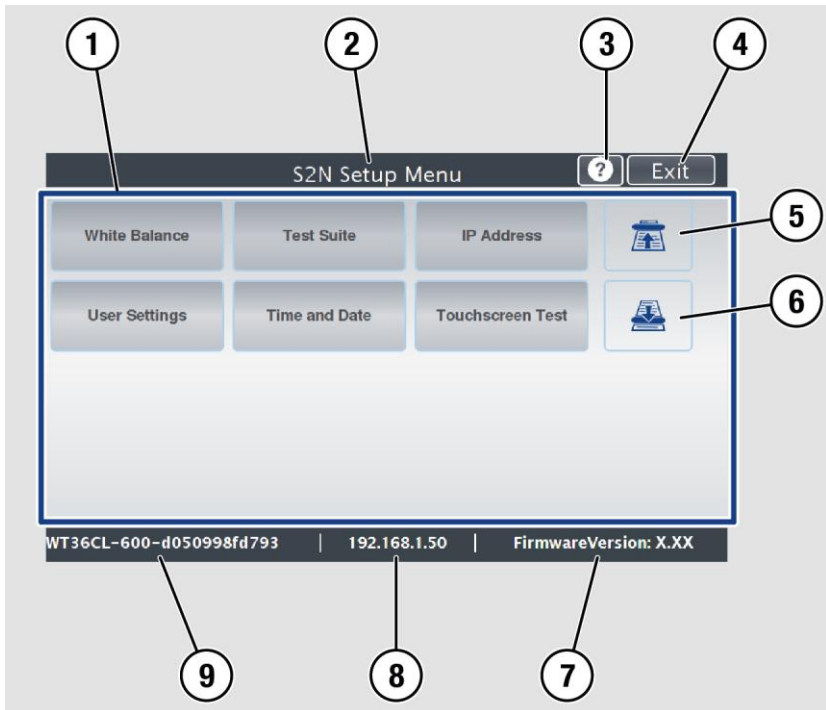

No.	Name
1	Buttons and parameters
2	Menu name
3	Display the online help ¹
4	Button to leave the setup menu to the start screen
5	Button to drive the document forward in the scanner
6	Button to drive the document backward in the scanner (rewind).
7	Firmware version
8	IP address
9	Serial number

¹ The display of the online help is only available when a second touchscreen is connected to the scanner.

Description

Rating Plate

The rating plate is attached to the back of the scanner.

The following figure shows the WideTEK® 36CL-600 rating plate.

Type/品类: Wide F. Scanner/大幅面扫描仪
Model/型号: WT36CL-600
Volt/电压: 19V  **Amperes/电流:** 3A



 Conforms to
 UL Std. 60950-1
 Cert. to CAN/CSA Std.
 C22.2 No. 60950-1
 Self Declaration: Conforms to IS 13252 (Part 1):2010, R-41006580



 Intertek

 Intertek
 3171507

 This device complies with part 15 of the FCC Rules. Operation is subject to the following two conditions: (1) This device may not cause harmful interference (2) this device must accept any interference received, including interference that may cause undesired operation.

Made in Germany 德国制造
 Image Access GmbH, Wuppertal
 www.imageaccess.de
 Serial No./Manufacturing Date on Barcode Label



The following figure shows the WideTEK® 48CL-600 rating plate.

Type/品类: Wide F. Scanner/大幅面扫描仪
Model/型号: WT48CL-600
Volt/电压: 19V  **Amperes/电流:** 3A



 Conforms to
 UL Std. 60950-1
 Cert. to CAN/CSA Std.
 C22.2 No. 60950-1
 Self Declaration: Conforms to IS 13252 (Part 1):2010, R-41006580



 Intertek

 Intertek
 3171507

 This device complies with part 15 of the FCC Rules. Operation is subject to the following two conditions: (1) This device may not cause harmful interference (2) this device must accept any interference received, including interference that may cause undesired operation.

Made in Germany 德国制造
 Image Access GmbH, Wuppertal
 www.imageaccess.de
 Serial No./Manufacturing Date on Barcode Label



The following figure shows the WideTEK® 60CL-600 rating plate.

Type/品类: Wide F. Scanner/大幅面扫描仪
 Model/型号: WT60CL-600
 Volt/电压: 19V  Amperes/电流: 3A

   Conforms to
 UL Std. 60950-1
 Cert. to CAN/CSA Std.
 C22.2 No. 60950-1
 Self Declaration: Conforms to IS 13252 (Part 1):2010, R-41006580

 
 Intertek
 Intertek
 3171507





 This device complies with part 15 of the FCC Rules. Operation is subject to the following two conditions: (1) This device may not cause harmful interference (2) this device must accept any interference received, including interference that may cause undesired operation.

 Made in Germany 德国制造
 Image Access GmbH, Wuppertal
 www.imageaccess.de

Serial No./Manufacturing Date on Barcode Label 

Prepare for Setup



Connect the Power Supply

 WARNING	
	<p>Risk of electric shock due to incorrect connection.</p> <ul style="list-style-type: none"> ➤ Ensure that the power receptacle intended for the connection is properly grounded. ➤ Ensure that the power receptacle intended for the connection of the scanner is properly fused.
 CAUTION	
	<p>Incorrect laying of the connection cables can cause tripping. Fractures, contusions and bruises can be the result.</p> <ul style="list-style-type: none"> ➤ Place the connecting cables so that nobody can trip over them.

To connect the power supply, proceed as follows:

- Make sure that the main switch of the scanner is switched off (0 position).
- Use only the AC adapter and power cord supplied.
- Ensure the power cord is not damaged.
- Connect the connector from the power supply to the associated 19 Vdc connector on the back of the scanner.
- If not already done, connect the supplied power cable to the associated connector on the power supply.
- Connect the power plug of the power supply to a power receptacle of the correct voltage (100-240 Vac).



Establish the Network Connection

 CAUTION	
	<p>Incorrect laying of the connection cables can cause tripping. Fractures, contusions and bruises can be the result.</p> <ul style="list-style-type: none"> ➤ Place the connecting cables so that nobody can trip over them.

To establish the network connection, proceed as follows:

- Connect one plug of the enclosed network cable to the network connector socket on the back of the scanner.
- Connect the second plug to the network socket of an existing network.



Positioning the Scanner on the Optional Floor Stand

 CAUTION	
	<p>The scanner weighs between 53 lbs. (24 kg) and 75 lbs. (34 kg).</p> <ul style="list-style-type: none">➤ Only carry the scanner with a second person.➤ Ensure that the scanner is secured so that it does not fall over.

To position the scanner on the optional floor stand, proceed as follows:

- Assemble the floor stand according to the floor stand assembly instructions.
- Position the scanner on the floor stand as described in the accompanying floor stand assembly instructions.



Connect the Optional Monitor

 CAUTION	
	<p>Incorrect laying of the connection cables can cause tripping. Fractures, contusions and bruises can be the result.</p> <ul style="list-style-type: none">➤ Place the connecting cables so that nobody can trip over them.

To connect the optional monitor, proceed as follows:

- Connect the HDMI connector plug of the monitor to the HDMI connector socket, located on the back of the scanner.

Connect the Optional Touchscreen

 CAUTION	
	<p>Incorrect laying of the connection cables can cause tripping. Fractures, contusions and bruises can be the result.</p> <ul style="list-style-type: none">➤ Place the connecting cables so that nobody can trip over them.

To connect the optional touchscreen, proceed as follows:

- Connect the HDMI connector plug of the touchscreen to the HDMI connector socket, located on the back of the scanner.
- Connect the USB connector plug of the touchscreen to the USB connector socket, located on the back of the scanner.

Switch On the Scanner

To switch on the scanner, proceed as follows:

- Press the MAIN SWITCH (1) on the back to the "I" position.

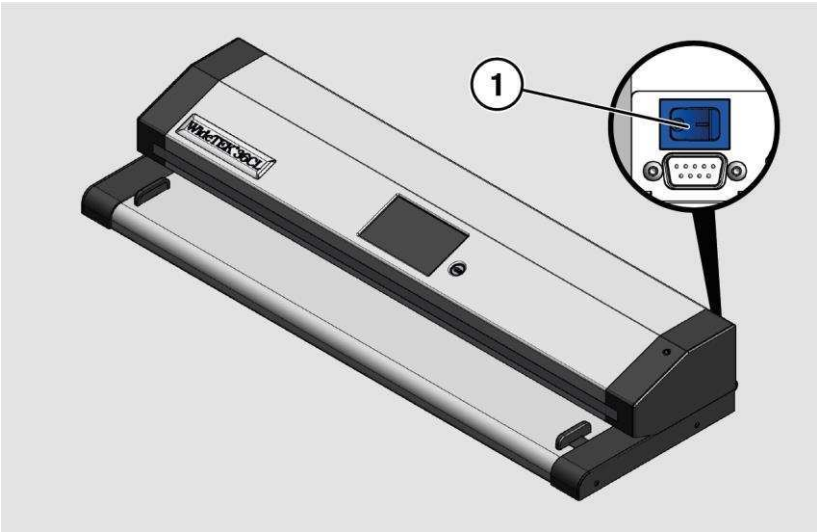

The scanner is in standby mode. The power button is illuminated in green.

Prepare for Setup

To start the scanner from standby mode, proceed as follows:

- Touch the green illuminated power button.

The power button lights up in blue.

The scanner performs a system test. After a short wait, the "Start screen" is displayed in English.

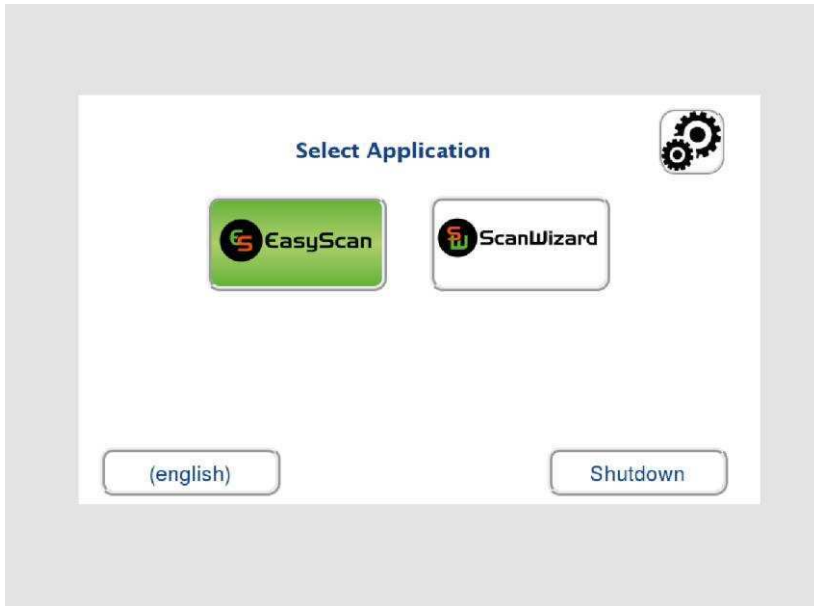

Switch Off the Scanner

To switch the scanner to standby mode after performing the setup, proceed as follows:

- On the "Start screen" screen tap on SHUTDOWN (1).

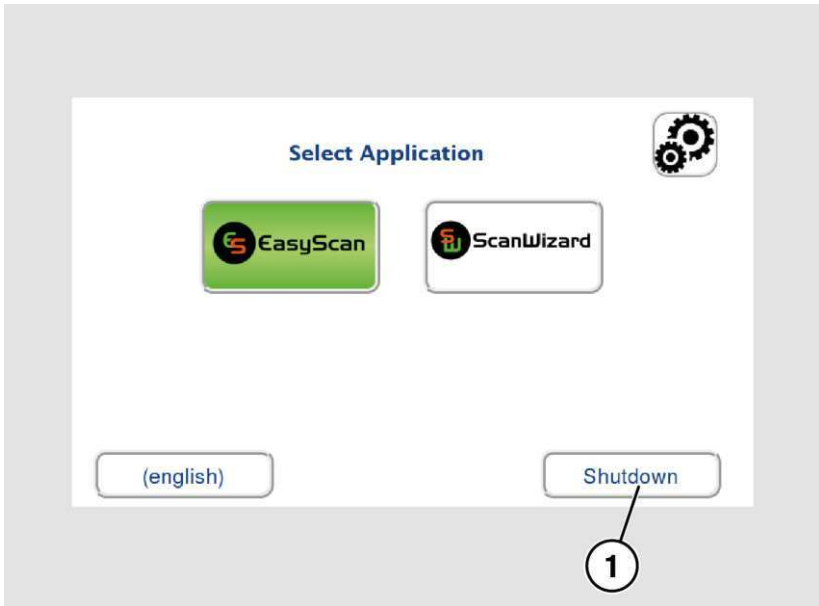

- Confirm with YES.

The scanner shuts down. This process can take up to 40 seconds.

The power button is illuminated in green. The scanner is in standby mode.

Alternatively, switch the scanner into the standby mode as follows:

- Touch the blue illuminated power button (2) and confirm the action in the dialog on the touchscreen.

The scanner shuts down. This process can take up to 40 seconds.

The power button lights up green. The scanner is in standby mode.

To switch off the scanner for longer periods, proceed as follows:

- Make sure that the scanner is in standby mode.

The power button is illuminated in green.

- Press the MAIN SWITCH (1) in the "0" position.

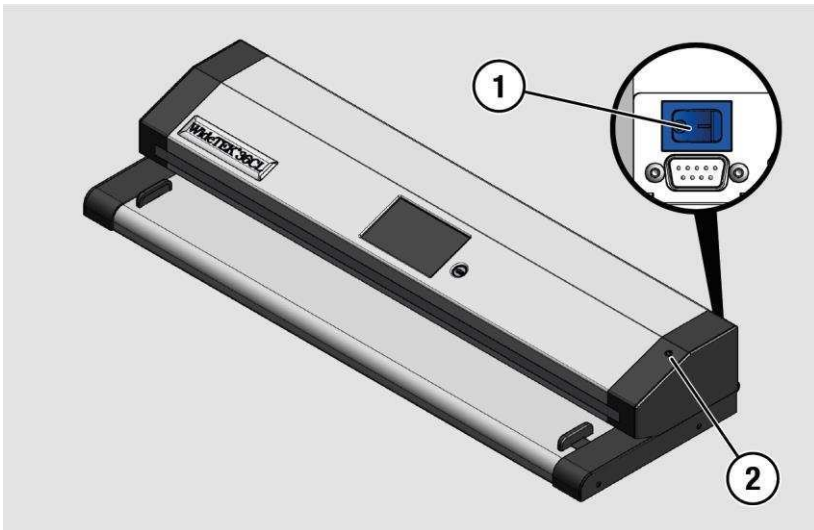

To switch off the scanner using a hard shutdown, proceed as follows:

- Press and hold the power button for longer than four seconds.

The power supply to the scanner is immediately interrupted.

The power button is illuminated in green.

- Press the MAIN SWITCH (1) in the "0" position.

Perform Setup

Change the Menu Language

To change the menu language, proceed as follows:

- Tap the LANGUAGE (1) button.

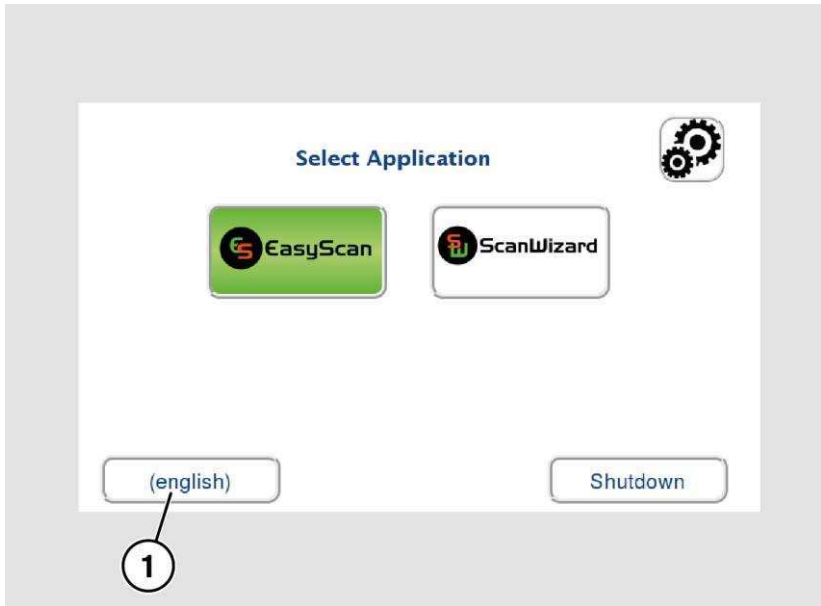

A window for selecting the language appears.

- To display more languages, slide the scroll bar (1) downward.



- Tap the desired language.

The window for selecting the language is closed. The "Start screen" is displayed.

Activate the Setup Menu

To activate the setup menu, you have to log in on the scanner. Proceed as follows:

- Tap the GEAR SYMBOL (1).

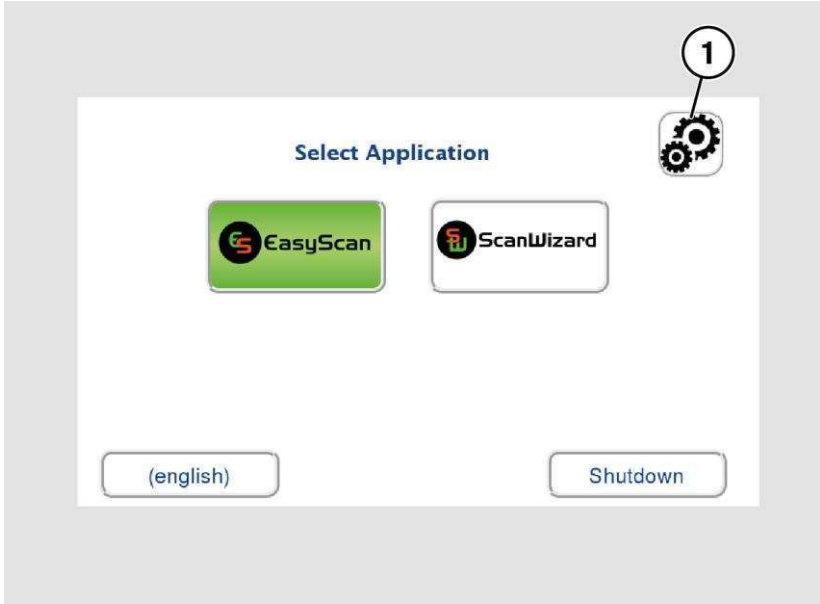

The login window appears.

- In the login window, enter the login credentials.
- To enter the credentials, tap with your finger on the corresponding input field.

The screen keyboard is displayed.

- Enter the word "Poweruser" in the fields "Username" (1) and "Password" (2).
- Please note that the input is case sensitive.

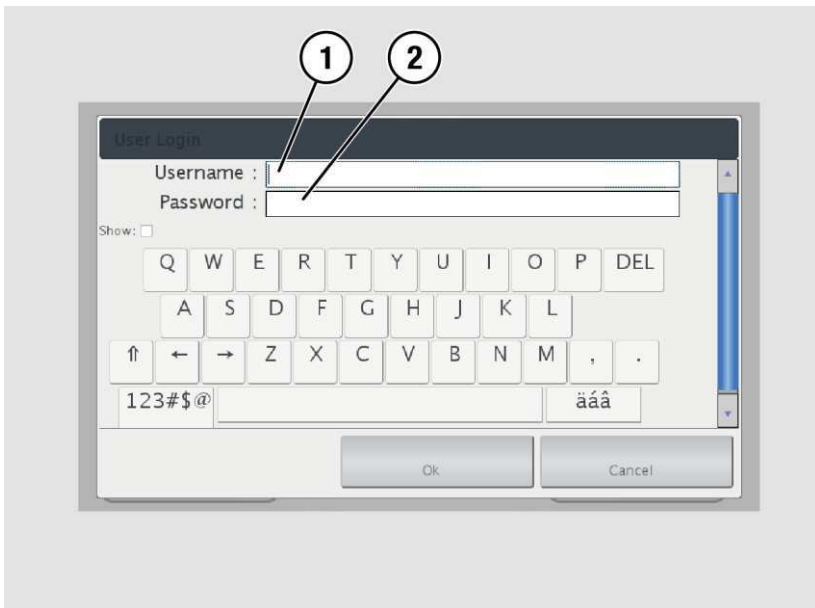

- To complete the log in, press OK (1).

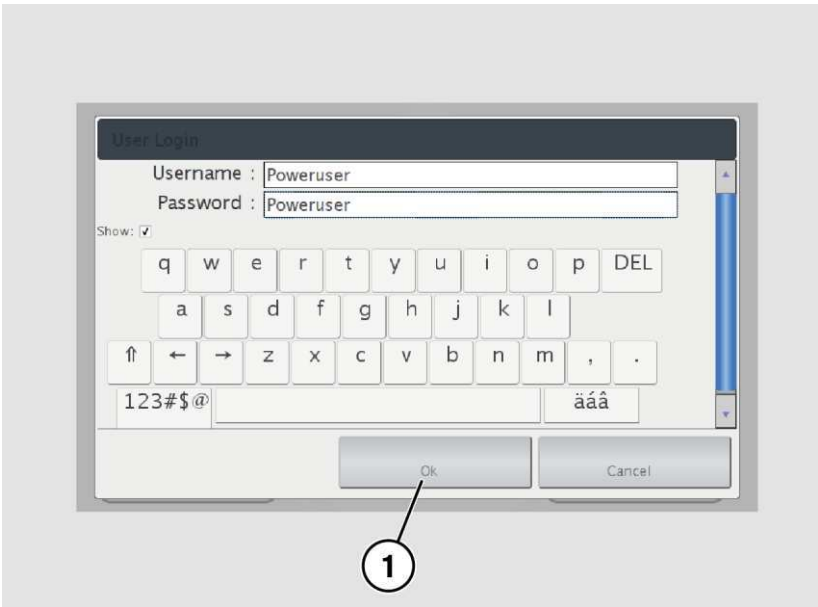

The "Setup Menu" screen is displayed.



White Balance: Display the "White Balance" submenu

Test Suite: Display the "Test Suite" submenu

IP Address: Display the "IP Address" submenu

User Settings: Display the "User Settings" submenu

Time and Date: Display the "Time and Date" submenu

- To select a submenu from the "S2N Setup menu" screen, tap with your finger on the button of the screen.

Perform White Balance - 36CL/48CL

- On the "Setup Menu" screen, tap on WHITE BALANCE (1).

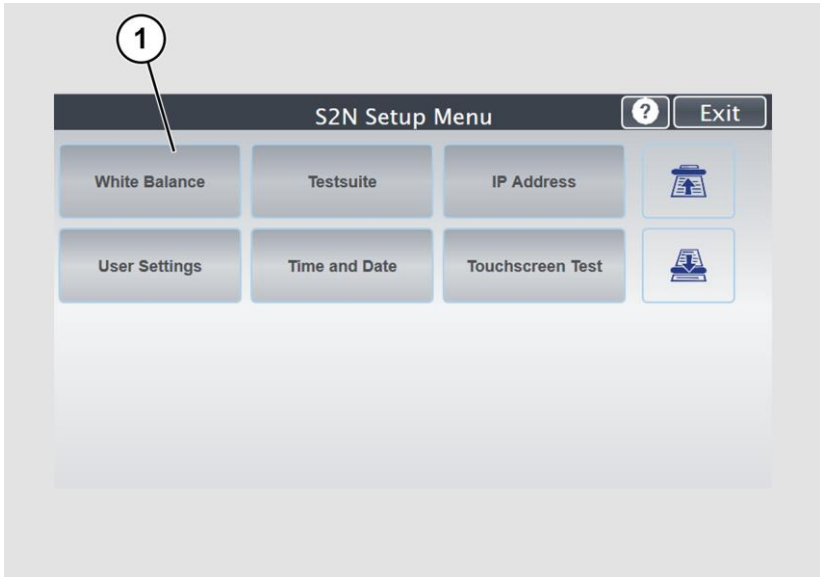

The "White Balance" screen is displayed.

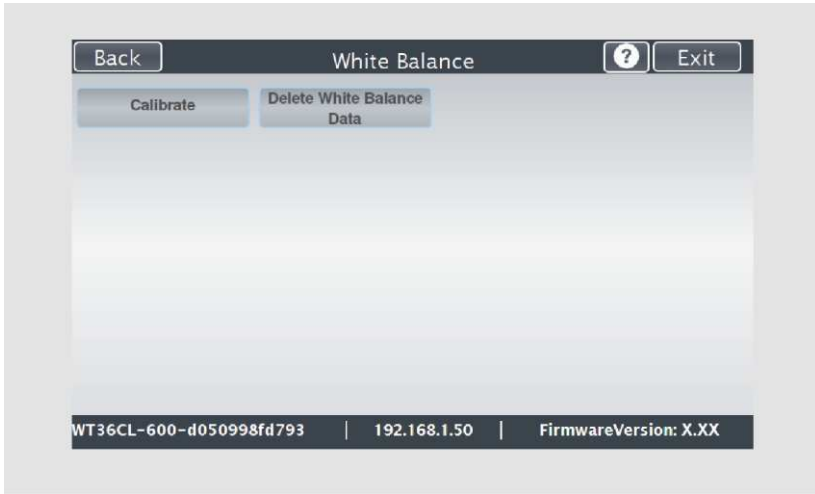

Calibrate: Start white balance
Delete White Delete existing white balance data
Balance Data:

The white balance is used to ensure the quality of the scan results. The white balance will be carried out using a test target. The test targets are marked as follows:

- WT36C-Z-01-A
- WT48-WA-01-A

Before beginning the white balance procedure, remove the transport guides. To remove the transport guides, proceed as follows:

- Lift the transport guides (1) approximately 5 mm (1.).
- Pull the transport guides (1) inwards (2.).

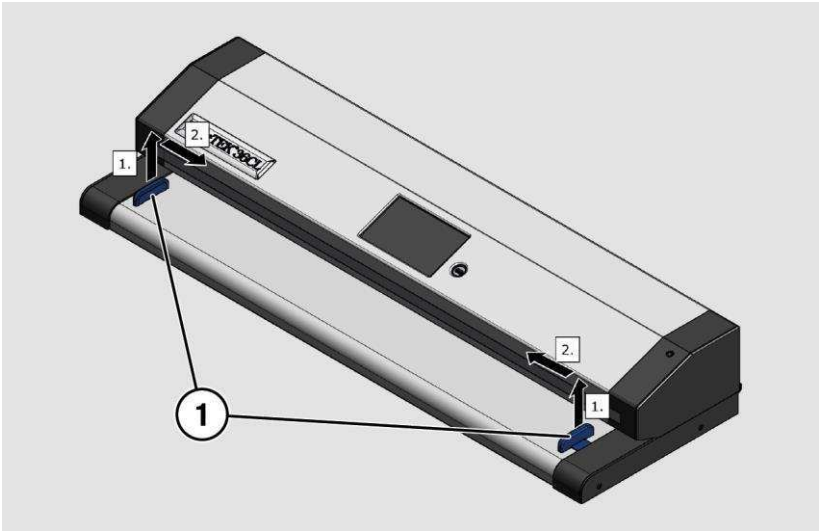

ATTENTION!

Impairment of the scan quality can occur if an improper test target for the white balance is used.

- Make sure that the test target is free from wrinkles, discolorations, cracks or other damage.
- Store the test target for the white balance in a safe place protected from daylight.

To perform the white balance, proceed as follows:

- Position the supplied test target (1) in the document transport as illustrated below (2).

The test target (1) is pulled into the scanner.

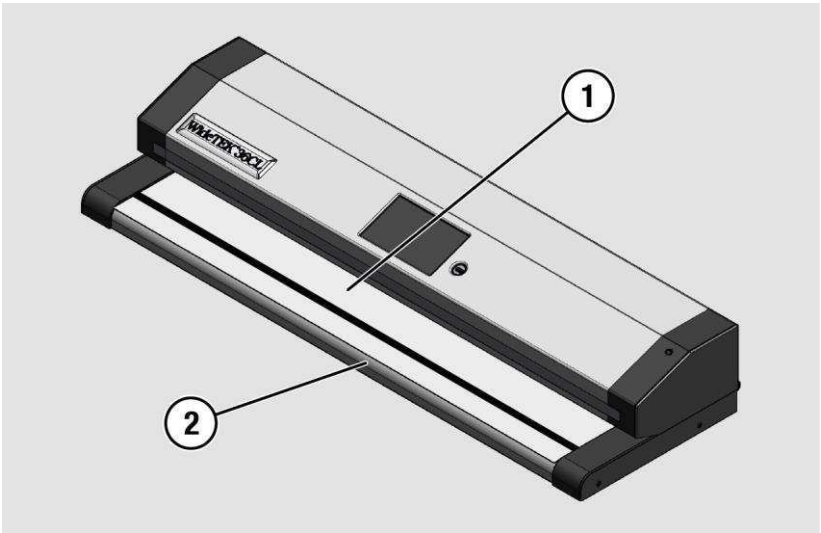

➤ Tap on CALIBRATE (1).

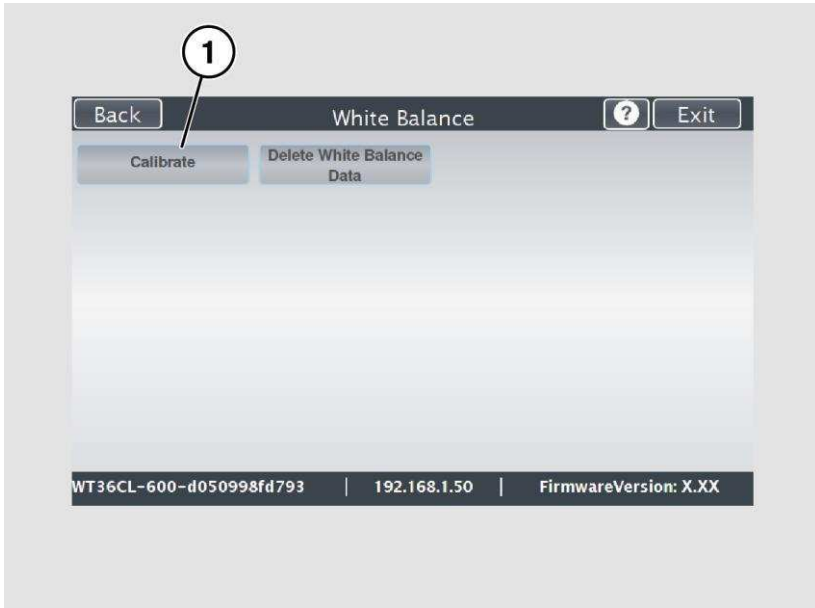

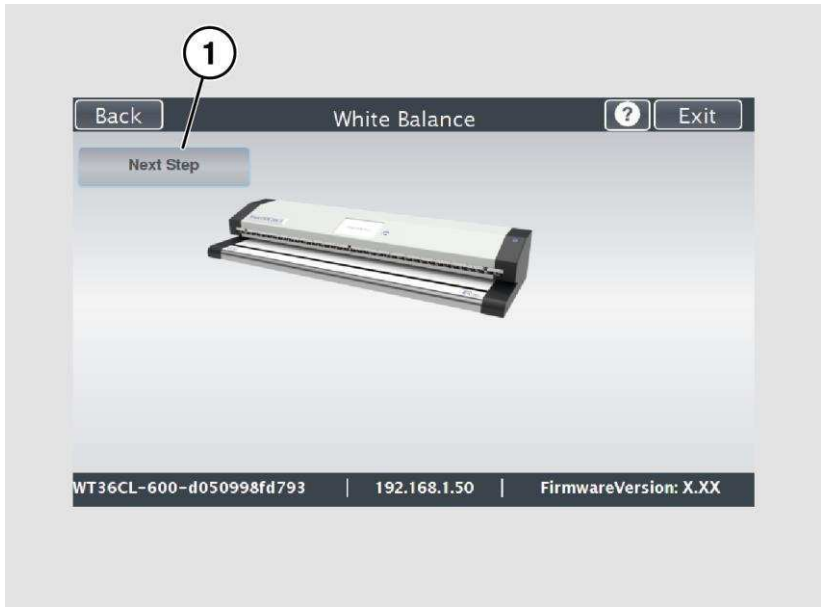

- Tap on NEXT STEP (1).

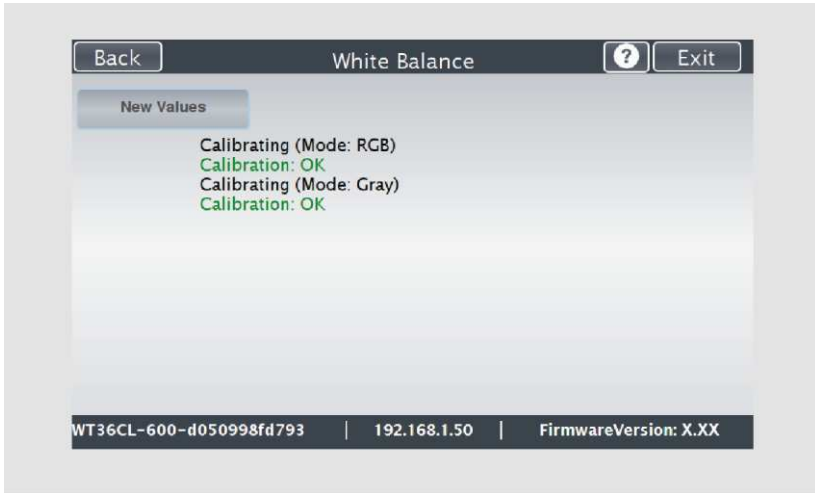

The white balance starts and the calibration is performed. During the white balance, a rotating icon appears. The test target is transported forward and returned. The entire white balance sequence takes about 18 seconds.

Then, the white balance result is displayed as shown in the example below.



-  On an error-free white balance calibration, the result is displayed in green.
An incorrect result is displayed in red. If this is the case, the white balance starts over again.

- To perform the white balance again, tap NEW VALUES (2).
- To return to the previous submenu, tap BACK (1).
- To return to the "Start screen", tap EXIT (3).

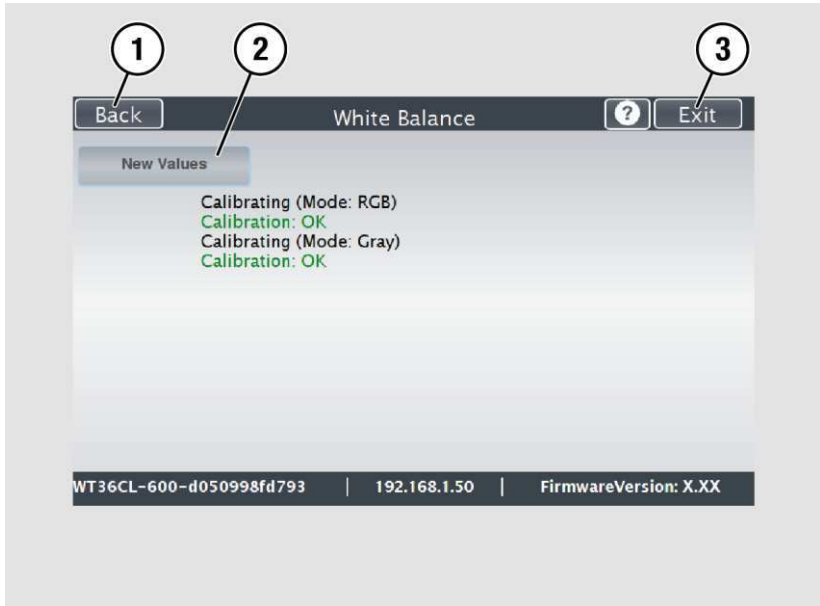

- To delete the stored data of the white balance calibration, tap DELETE WHITE BALANCE DATA (2).
- After deleting the stored data, run the white balance again, as described.
- If problems arise during the white balance calibration, contact Image Access technical support, see section *Technical Support* starting at page 7.
- To return to the previous submenu, tap BACK (1).
- To return to the "Start screen", tap EXIT (3).

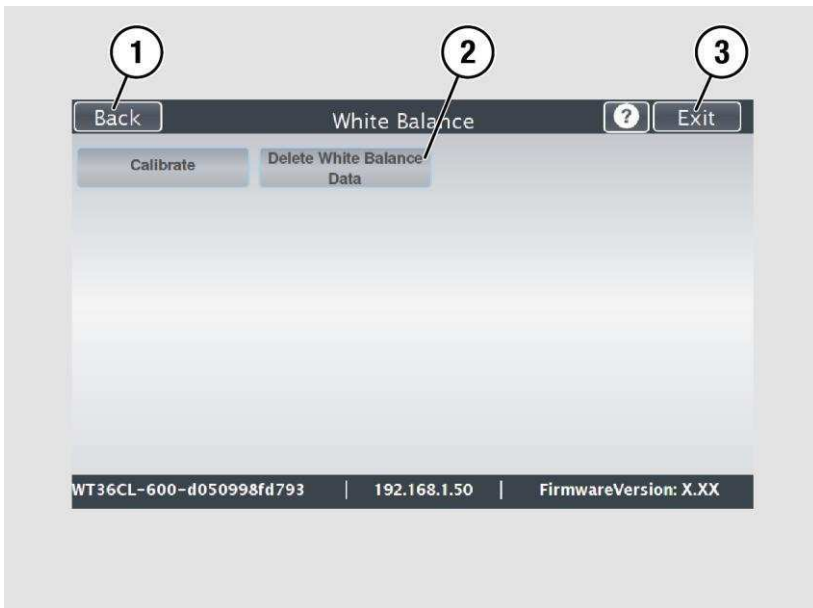

After a successful white balance, proceed as follows:

- Remove the test target.
- Put the transport guides back into their position.
- Store the test target in a place which is protected from daylight.
- Ensure that the test target is not damaged, wrinkled or soiled.

Perform White Balance - 60CL

- On the "Setup Menu" screen, tap on WHITE BALANCE (1).

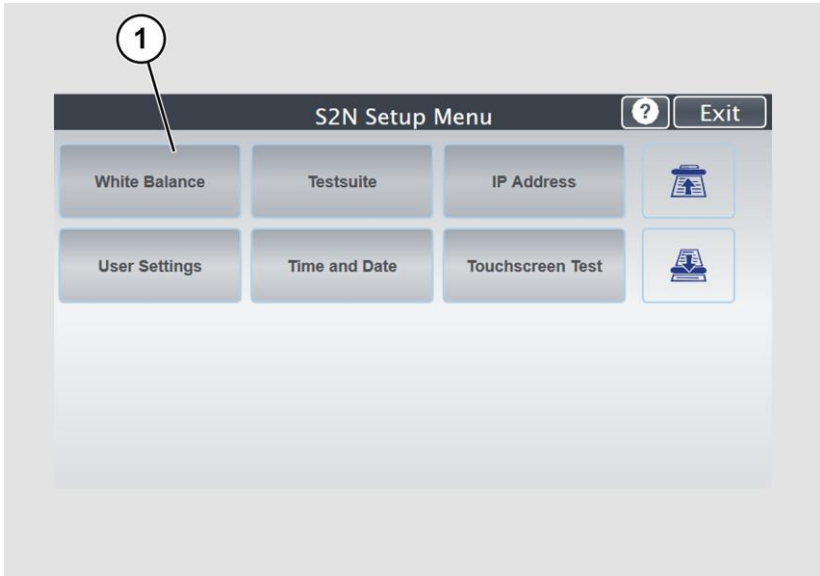

The "White Balance" screen is displayed.

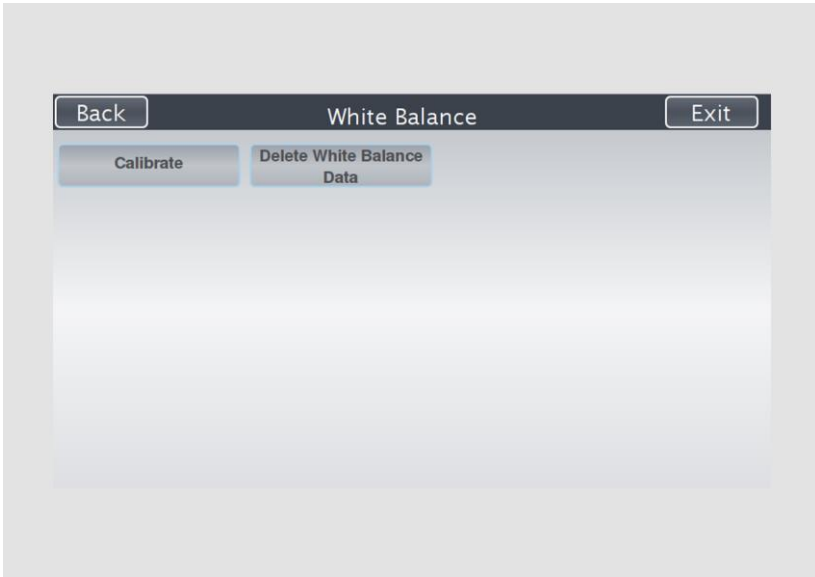

Calibrate: Start white balance
Delete White Delete existing white balance data
Balance Data:

The white balance is used to ensure the quality of the scan results. The white balance will be carried out using a test target. The test target is marked as follows:

- WT36C-Z-01-A

Before beginning the white balance procedure, remove the transport guides. To remove the transport guides, proceed as follows:

- Lift the transport guides (1) approximately 5 mm (1.).
- Pull the transport guides (1) inwards (2.).

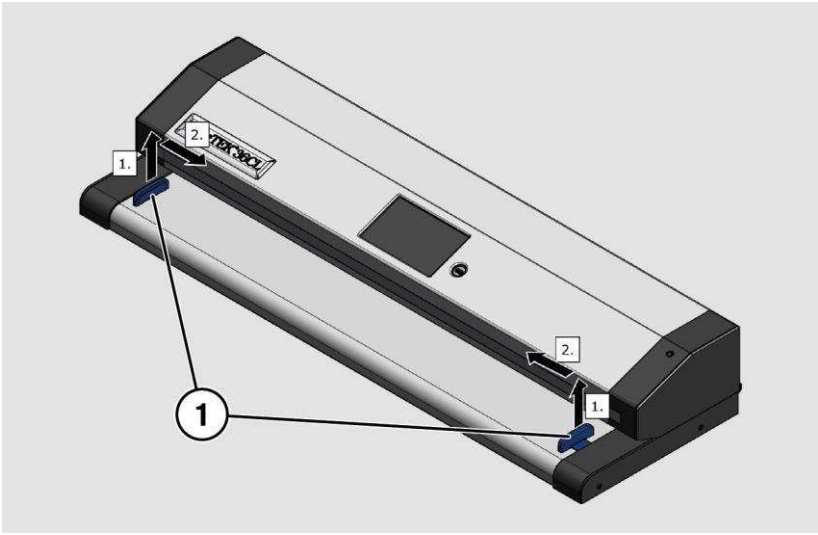

ATTENTION!

Impairment of the scan quality can occur if an improper test target for the white balance is used.

- Make sure that the test target is free from wrinkles, discolorations, cracks or other damage.
- Store the test target for the white balance in a safe place protected from daylight.

Perform Setup

To perform the white balance, proceed as follows:

- Position the supplied test target (1) in the document transport as illustrated below (2).

The test target (1) is pulled into the scanner.

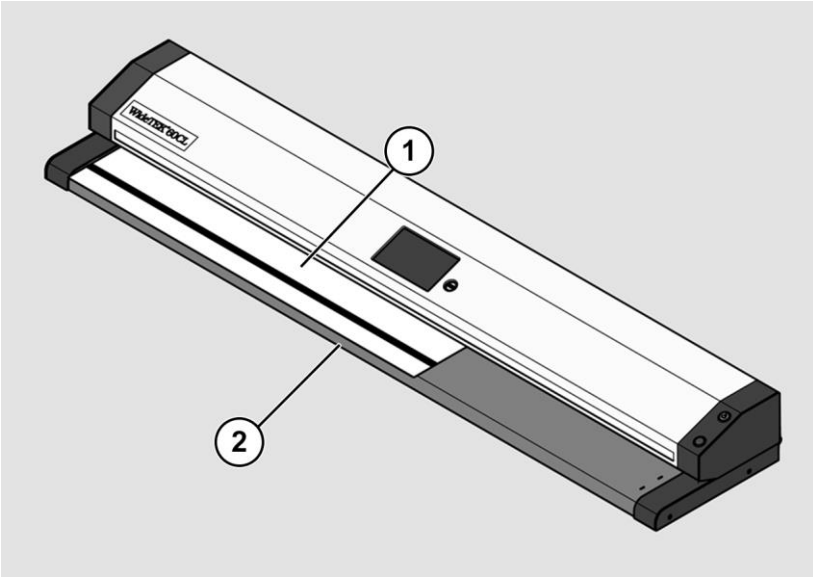

- Tap on CALIBRATE (1).

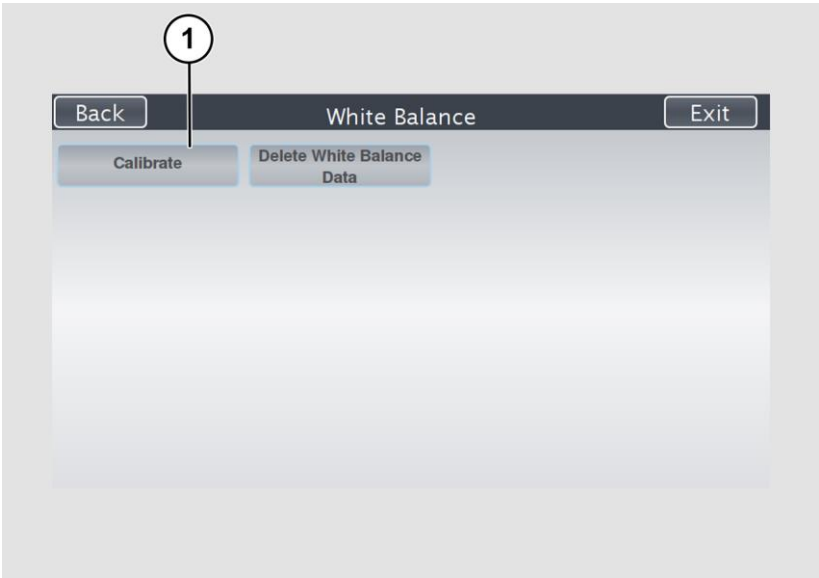

➤ Tap on NEXT STEP (1).

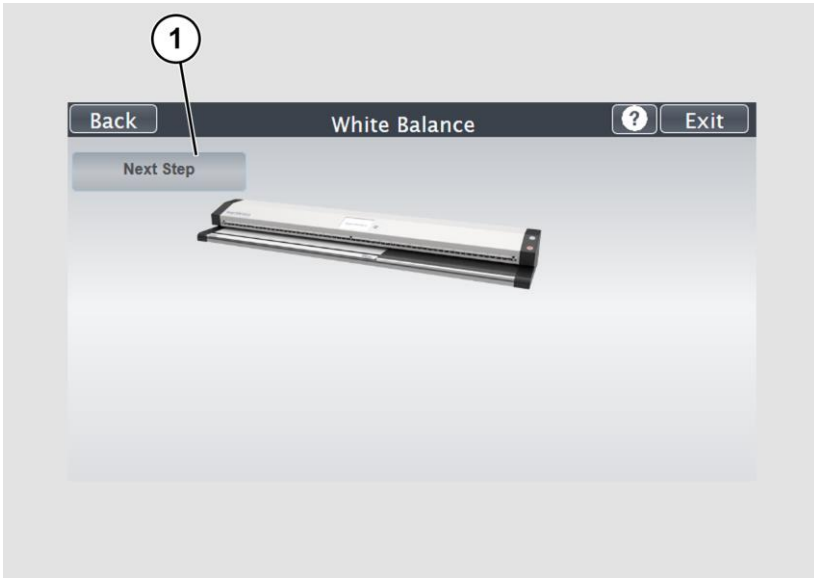

The white balance starts, and the calibration is performed. During the white balance, a rotating icon appears. The test target is transported forward and returned. The entire white balance sequence takes about 18 seconds.

Then, the white balance result is displayed as shown in the example below.

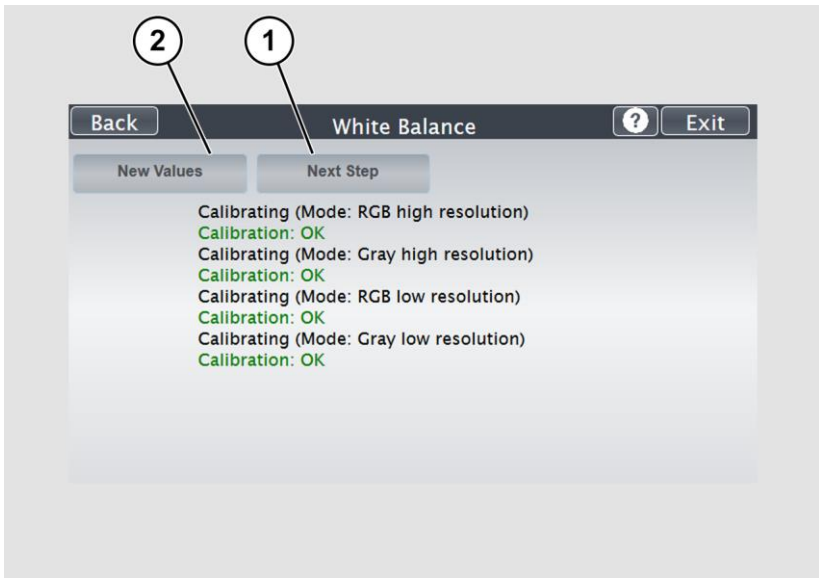

- i** On an error-free white balance calibration, the result is displayed in green.
An incorrect result is displayed in red. If this is the case, repeat the white balance calibration by a click on NEW VALUES (2).

Perform Setup

To perform the second white balance, proceed as follows:

- Position the supplied test target (1) in the document transport as illustrated below (2).

The test target (1) is pulled into the scanner.

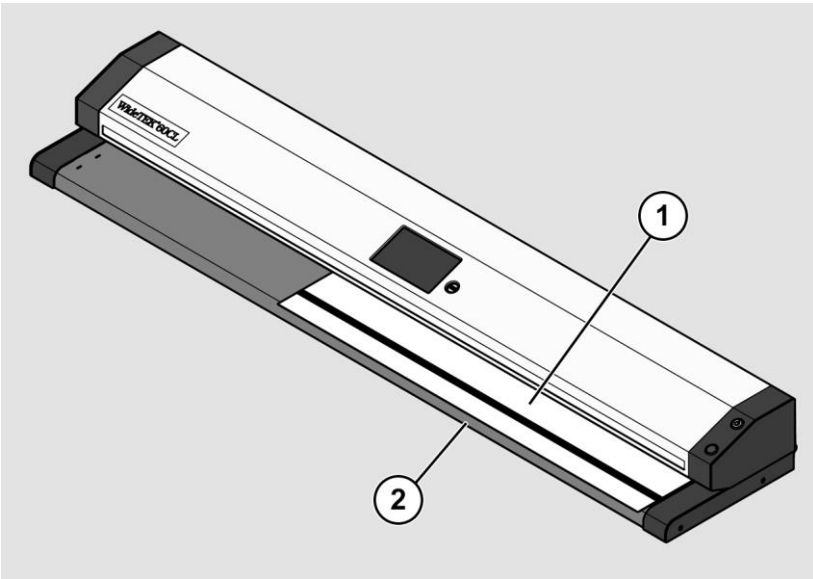

- Tap on NEXT STEP (1).

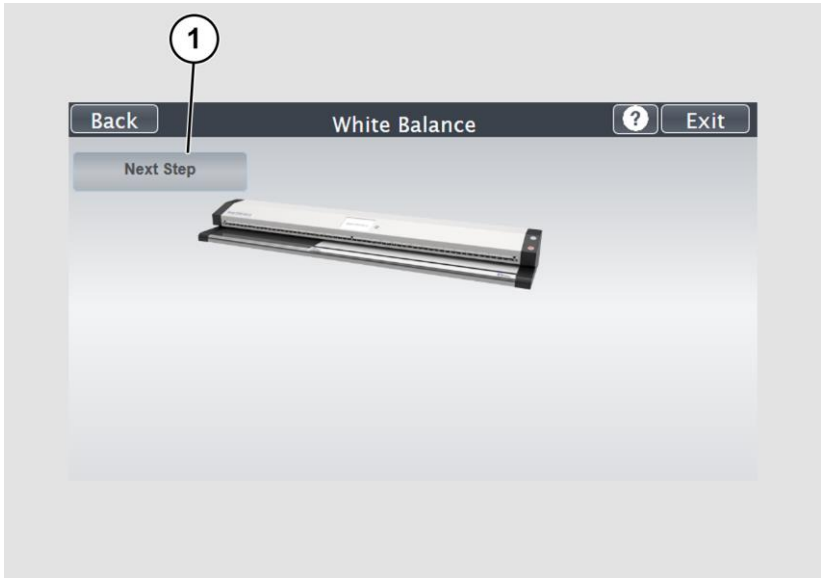

The white balance starts, and the calibration is performed. During the white balance, a rotating icon appears. The test target is transported forward and returned. The entire white balance sequence takes about 18 seconds.

Then, the white balance result is displayed as shown in the example below.

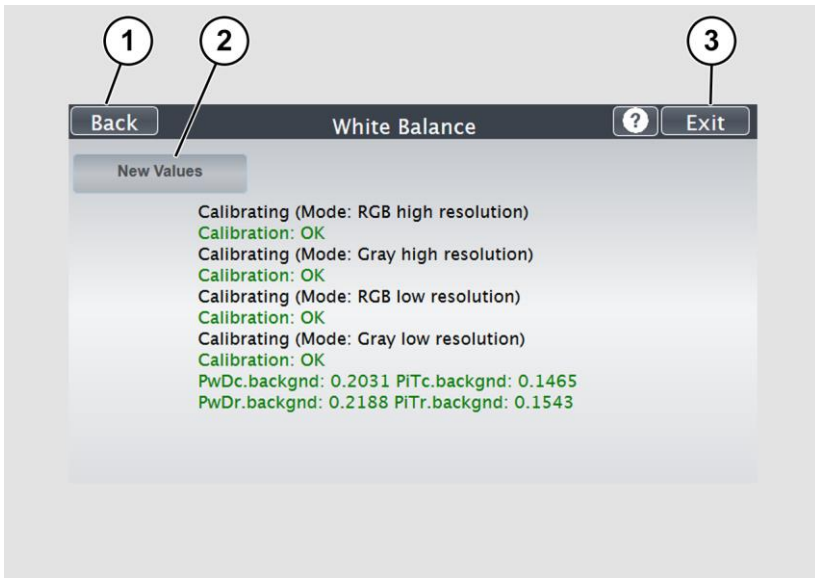

- To return to the previous submenu, tap BACK (1).
- To return to the "Start screen", tap EXIT (3).

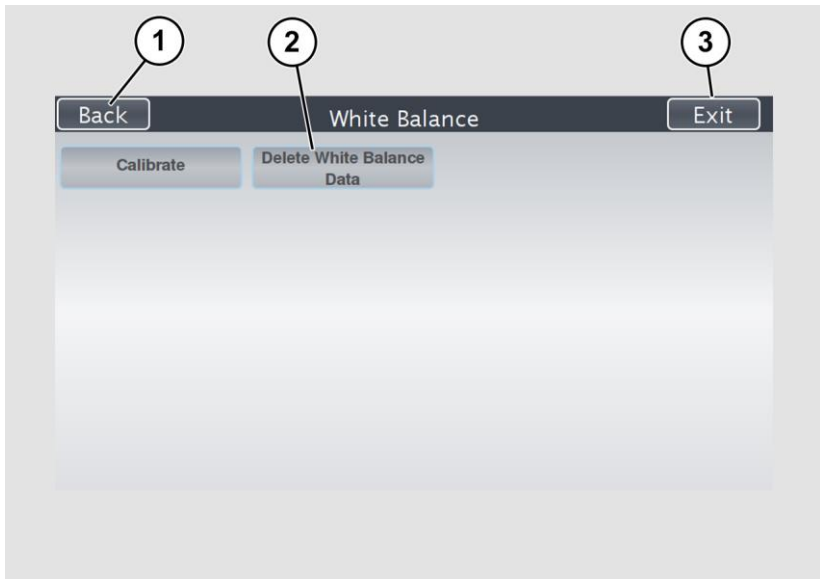

- To delete the stored data of the white balance calibration, tap DELETE WHITE BALANCE DATA (2).
- After deleting the stored data, run the white balance again, as described.
- If problems arise during the white balance calibration, contact Image Access technical support, see section *Technical Support* starting at page 7.
- To return to the previous submenu, tap BACK (1).
- To return to the "Start screen", tap EXIT (3).

After a successful white balance, proceed as follows:

- Remove the test target.
- Put the transport guides back into their position.
- Store the test target in a place which is protected from daylight.
- Ensure that the test target is not damaged, wrinkled or soiled.

Assign the IP Address

Manually Assign the IP Address

To manually assign the IP address, proceed as follows:

- On the "Setup Menu" screen, tap on IP Address (1).

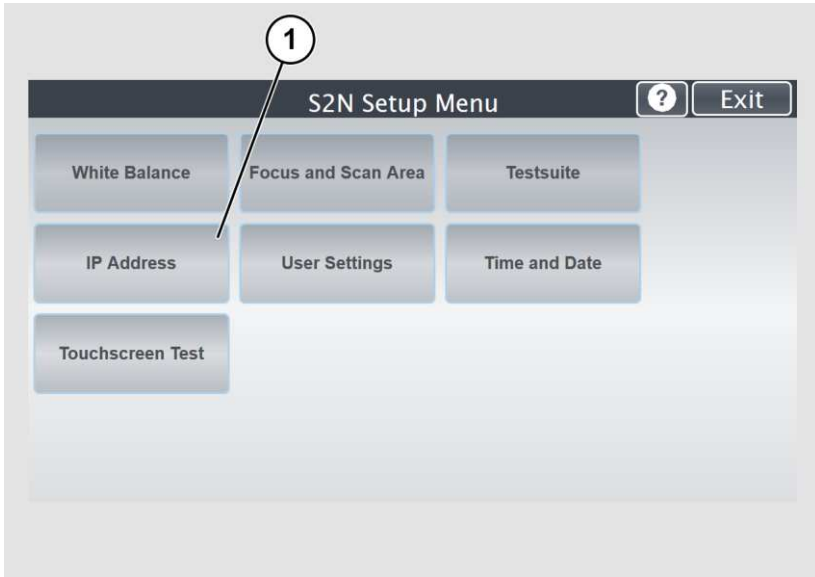

The "IP Address" screen is displayed.



Set network settings:

Accept the network settings provided

Reset to Factory:

Reset to factory settings

IP Address:

Input field for the IP address

Default Gateway:

Input field for the gateway address

Subnet Mask:

Input field for data on the subnet mask

IP Configuration Method

Assign an IP address manually or automatically

Manual/DHCP:

➤ Tap the "IP Address" (1) field.

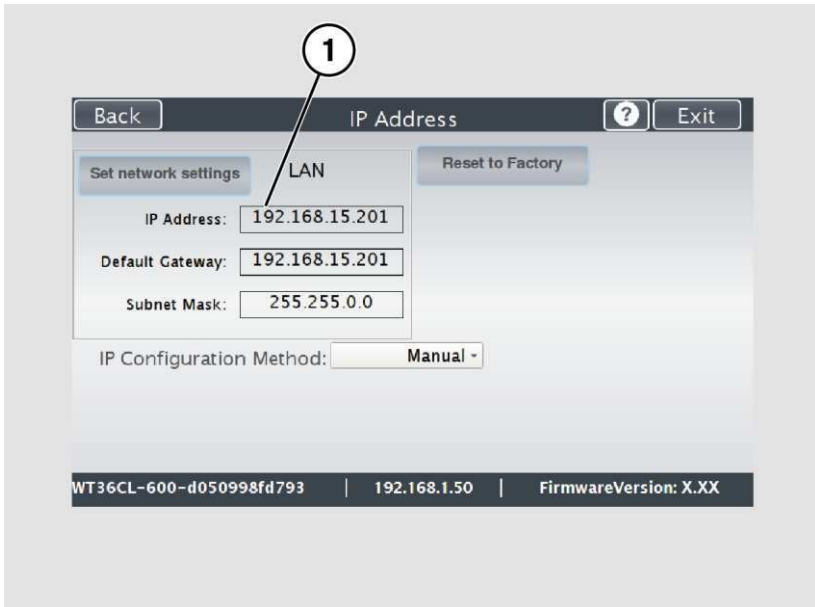

The "IP Address" window is displayed.

- Enter the IP address (1).

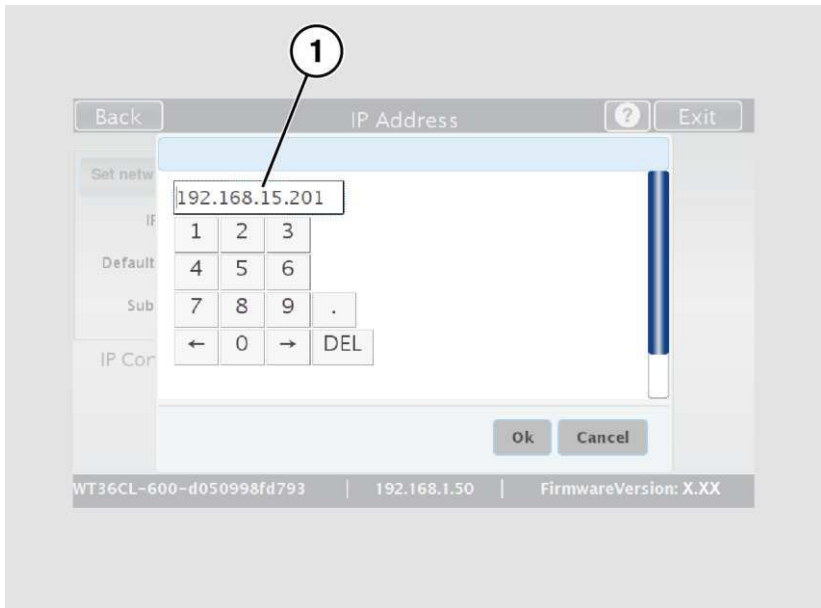

- To delete a digit, move the cursor to the right, behind the digit to be deleted and tap DEL (1).

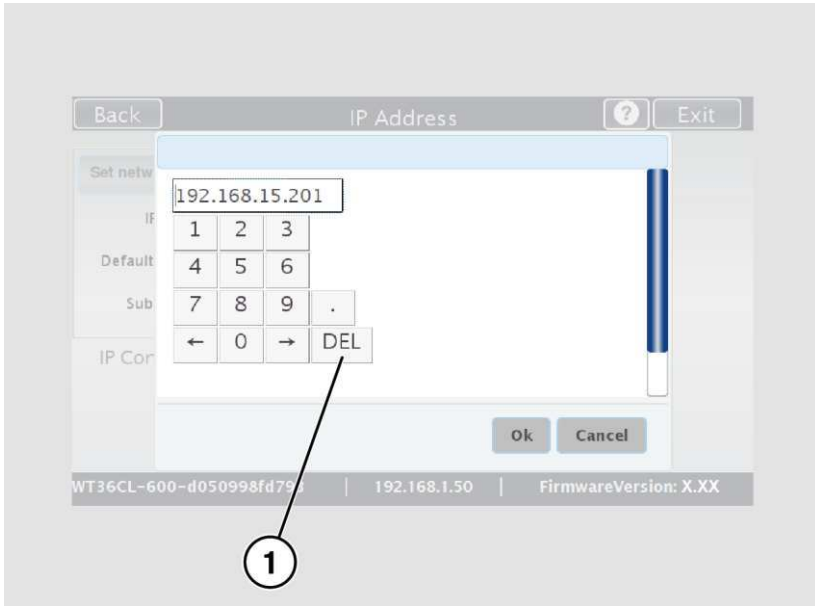

The arrow keys left (1) and right (2) next to the number "0" move the cursor within the chosen row.

- To complete the entry, press OK (3).
- Perform the settings for gateway and subnet mask in the same way.

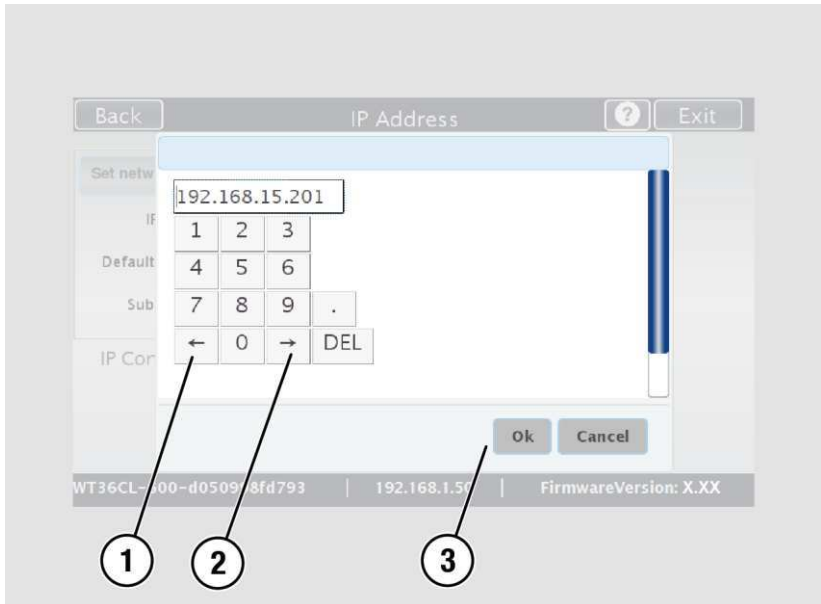

- To save the network settings, tap SET NETWORK SETTINGS (2).
- To return to the previous submenu, tap BACK (1).
- To return to the "Start screen", tap EXIT (3).

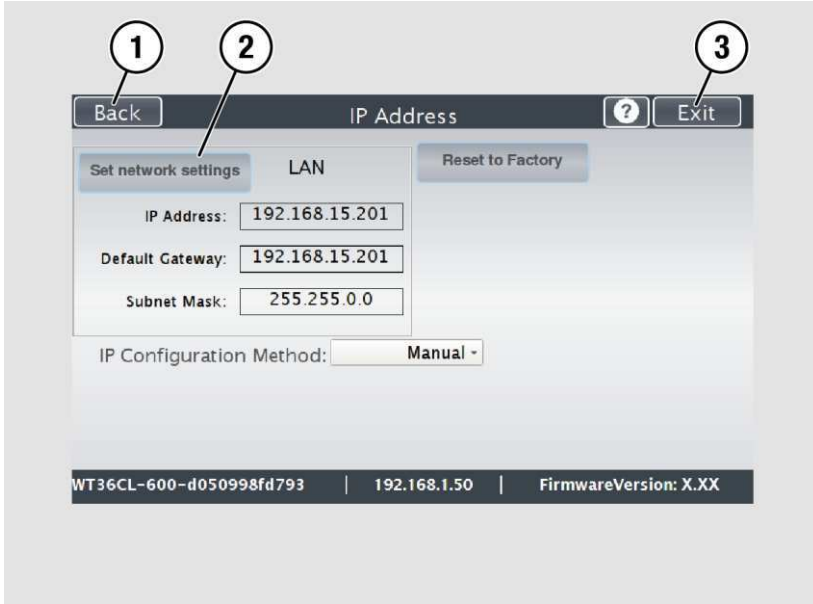

Automatically Assign the IP Address

To automatically assign the IP address, proceed as follows:

- On the setup menu screen, press the button IP ADDRESS (1).

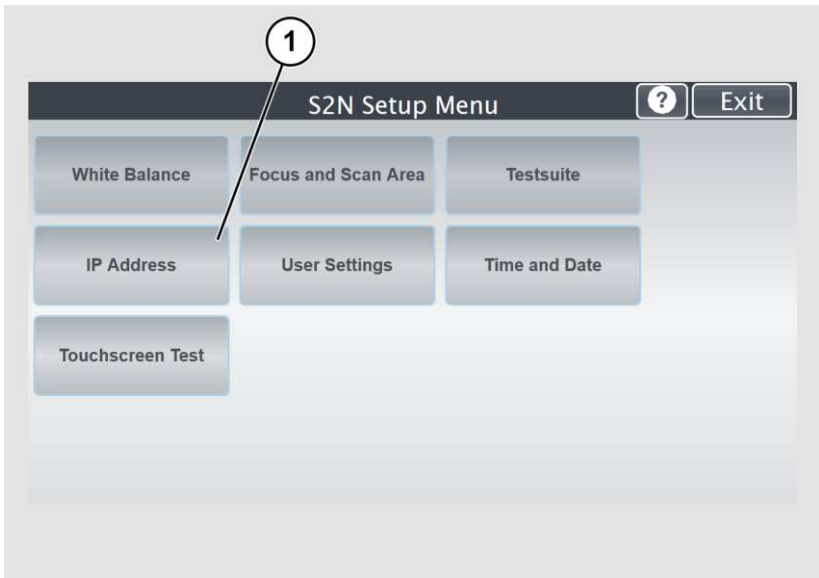

Perform Setup

- In the selection menu "IP Configuration Method", select the "DHCP" (3) entry.
- To return to the previous submenu, tap BACK (1).
- To return to the "Start screen", tap EXIT (2).

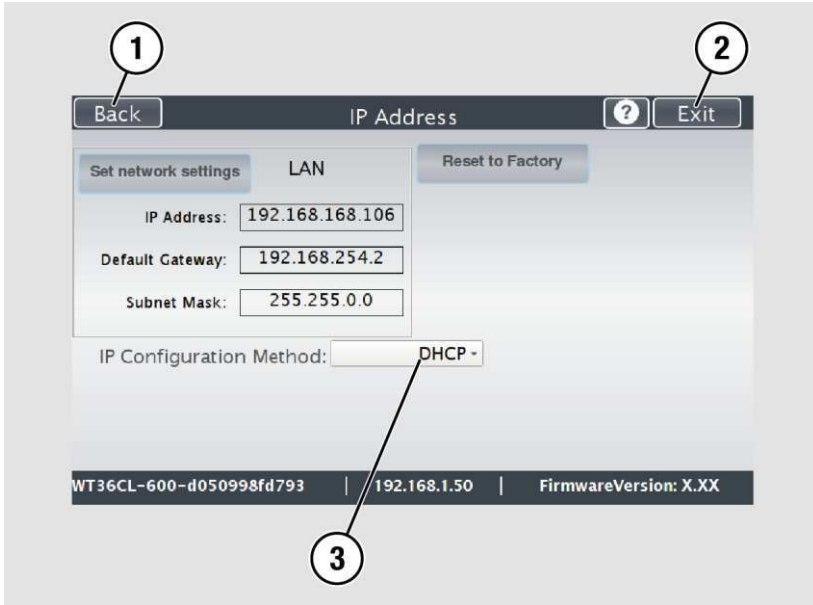

Modify User Settings

- On the "Setup Menu" screen, tap on USER SETTINGS (1).

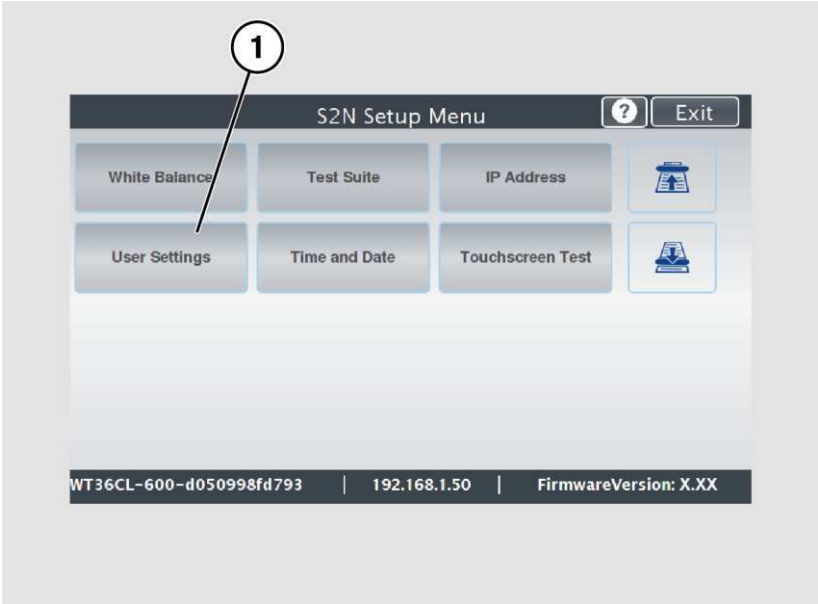

The "User Settings" screen is displayed.

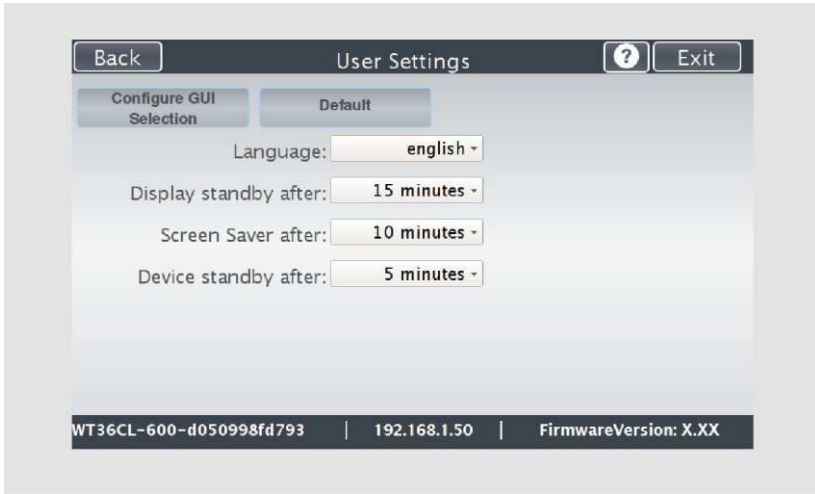

- | | |
|--------------------------|--|
| Configure GUI Selection: | Open the submenu for setting the application in the start screen |
| Default: | The scanner default settings will be established again |
| Language: | Select language |
| Display standby after: | Define the period of inactivity, until an optional external monitor and the touchscreen switch to the standby mode |
| Screen Saver after: | The period of inactivity is defined until the screen saver is activated |
| Device standby after: | The period of inactivity is defined, until the scanner goes into standby mode |

Select Language

To select the language, proceed as follows:

- Tap the on the selection arrow of the selection menu "Language" to display the list of languages.
- Tap the desired language (2).
- To return to the previous submenu, tap BACK (1).
- To return to the "Start screen", tap EXIT (3).

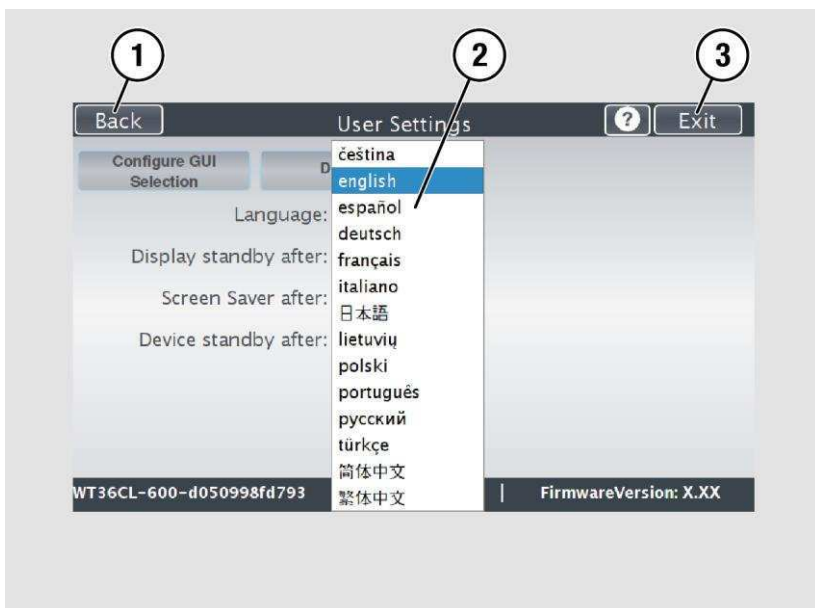

Set Standby Times

To set the standby times, proceed as follows:

- Tap the selection arrow of the selection menu.
- Tap on the desired entry (2).
- Perform the settings for the screen saver and the device standby in the same way.
- To return to the previous submenu, tap BACK (1).
- To return to the "Start screen", tap EXIT (3).

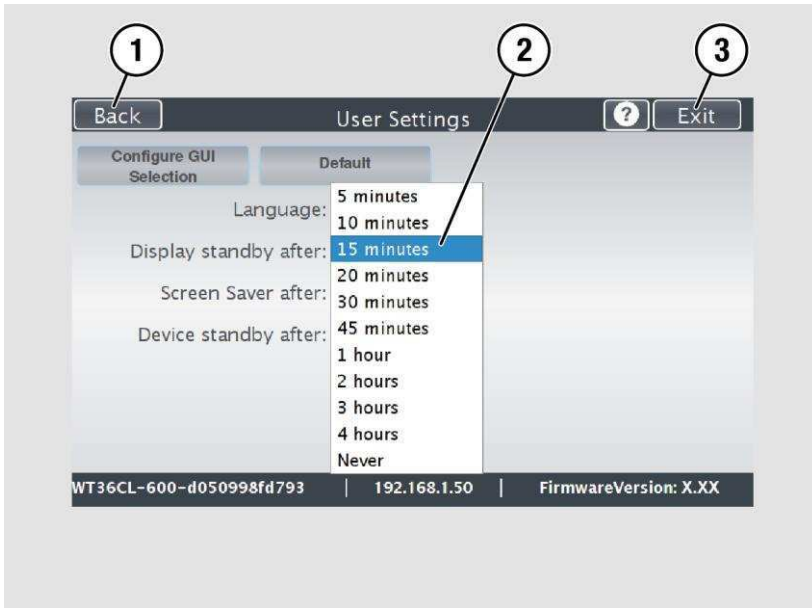

Configuring the GUI Selection

- Tap the "User Settings" screen on CONFIGURE GUI SELECTION (1).

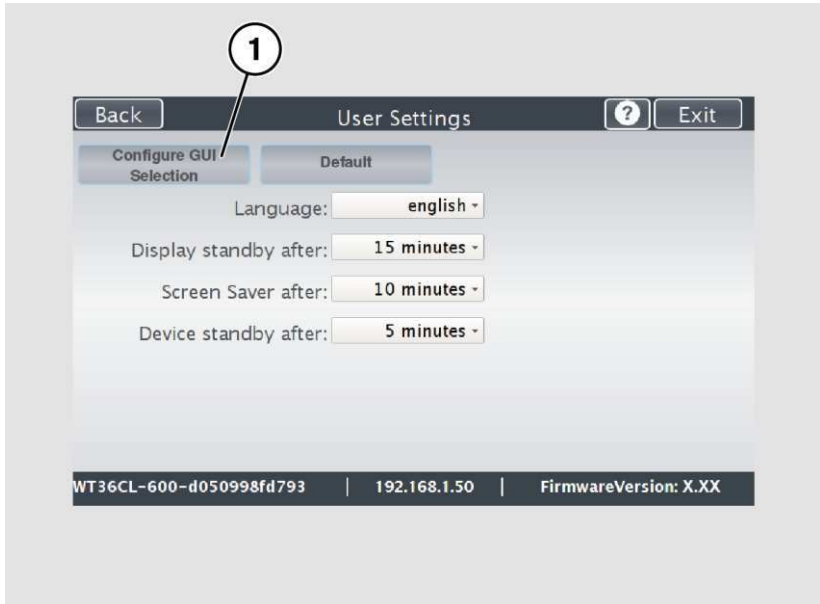

The "Configure GUI Selection" screen is displayed.

This menu displays the "EasyScan" and "ScanWizard" applications, which are available as a standard selection. If after system start you want to display only one of the applications, proceed as follows:

- Under "Displays" (1) disable the box corresponding to the application you do not want to display.

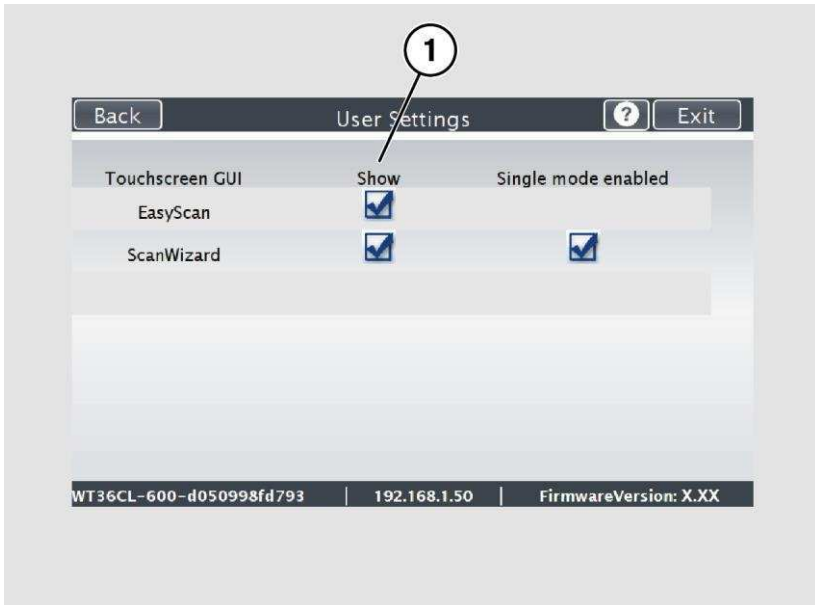

By default, single mode is defined (activate the checkbox "Single mode enabled").

- To start the application in job mode, uncheck the checkbox "Single mode enabled" (2).
- To return to the previous submenu, tap BACK (1).
- To return to the "Start screen", tap EXIT (3).

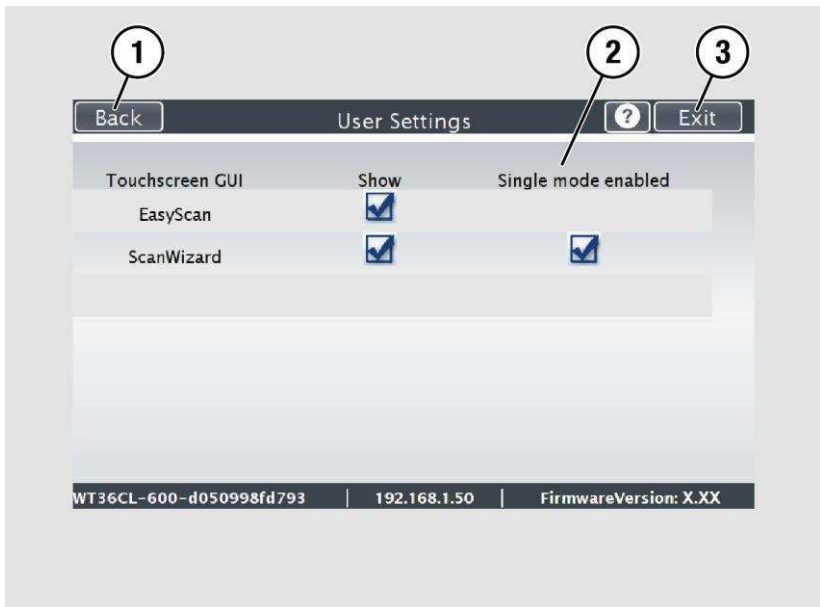

Set the Time and Date

- On the "Setup Menu" screen, tap on TIME and DATE (1).

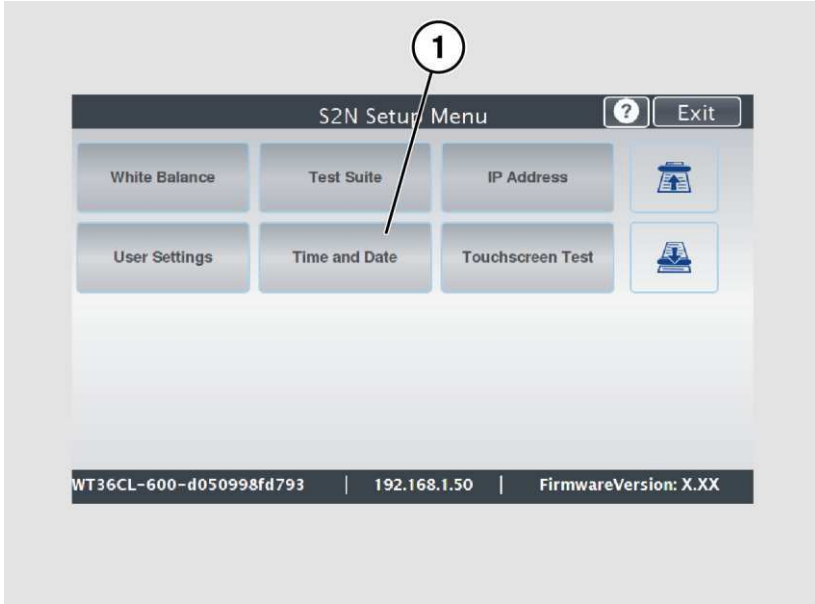

The screen "Time and Date" appears.

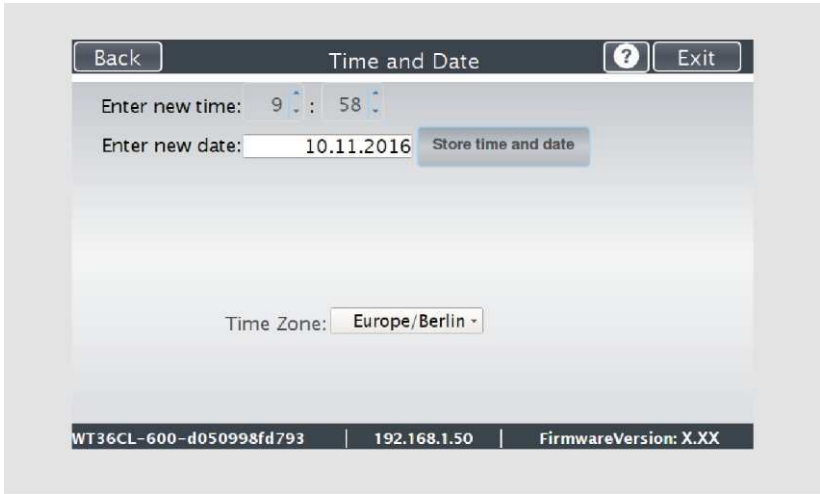

- | | |
|----------------------|---|
| Enter new time: | Enter hours and minutes with the arrow keys |
| Enter new date: | Open a calendar to set the date |
| Store time and date: | Accept the set values |
| Time Zone: | Select a time zone |

Perform Setup

To set the time, proceed as follows:

- Tap the "Enter new time" field.
- To set the time later, tap the up arrow (2).
- To set the time earlier, tap the down arrow (2).
- To save the modified time, click STORE TIME AND DATE (3).
- To return to the previous submenu, tap BACK (1).
- To return to the "Start screen", tap EXIT (4).

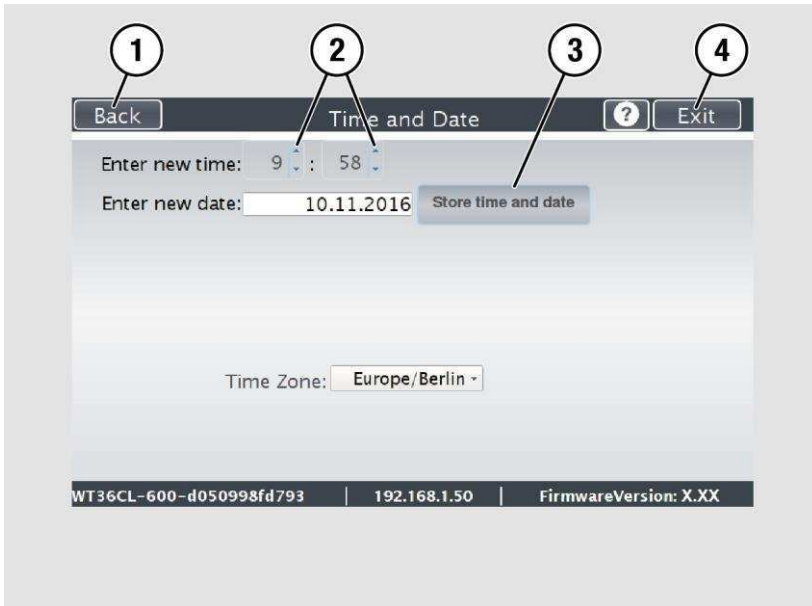

To set the date, proceed as follows:

- Tap the "Enter new date" field.

A calendar (3) is displayed.

- Select the appropriate date in the calendar (3).
- To set the month and year, tap the arrow keys (2, 4) at the top of the calendar.
- To set the day, tap the corresponding day in the calendar.
- To save the date, click STORE TIME AND DATE (5).
- To return to the previous submenu, tap BACK (1).
- To return to the "Start screen", tap EXIT (6).

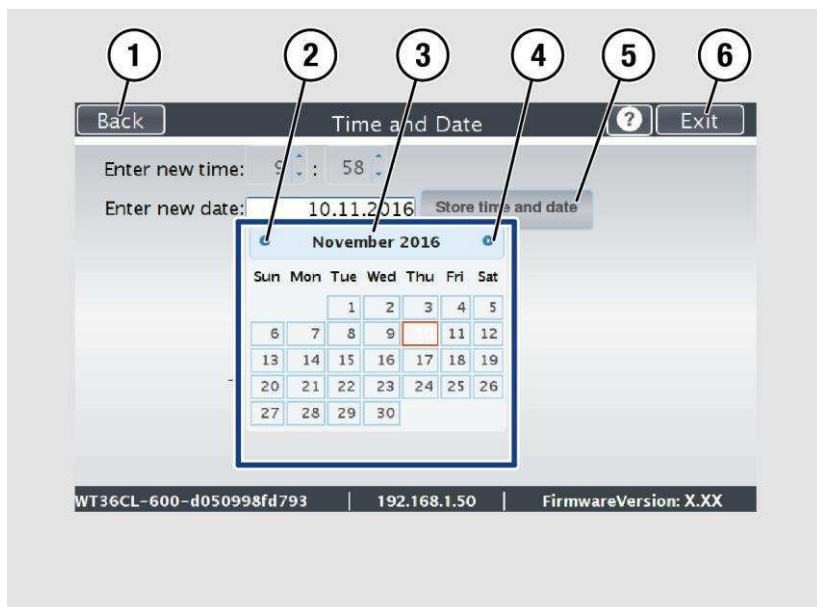

Perform Setup

- To select the time zone, tap the selection arrow (4).
A selection list with available time zones is displayed.
- Select the appropriate time zone.
- To save the time zone, click STORE TIME AND DATE (2).
- To return to the previous submenu, tap BACK (1).
- To return to the "Start screen", tap EXIT (3).

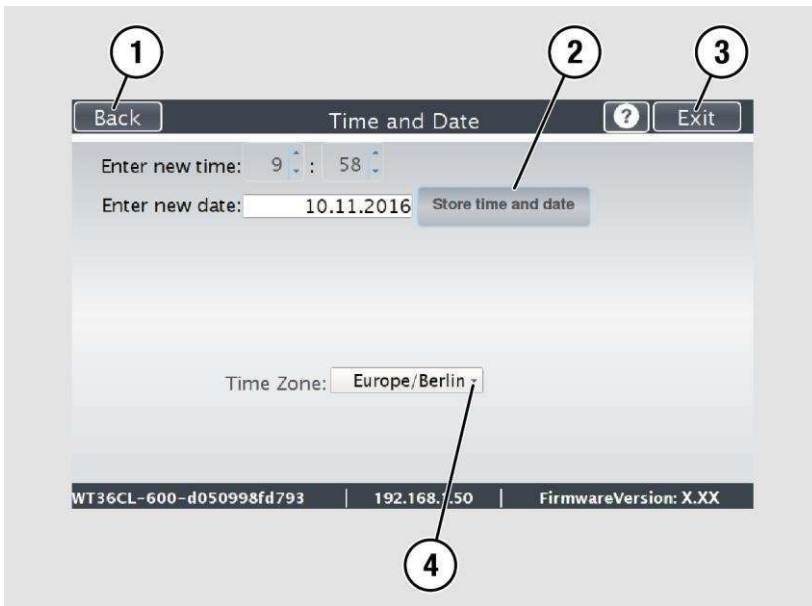

Perform Test Suite

- On the "Setup Menu" screen, tap on TESTSUITE (1).



The "Testsuite" screen is displayed.

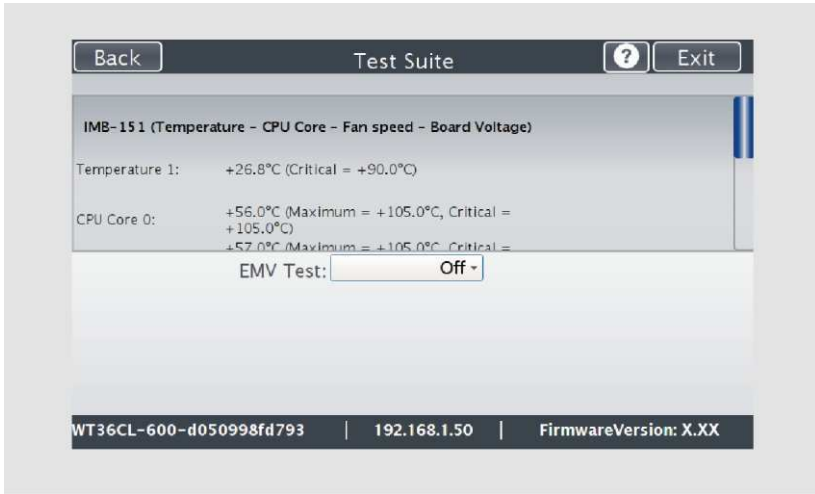

Information about the mainboard:

Display the current values for: Temperature of PCB and CPU cores, fan speed, PCB voltages

Information for testing electromagnetic compatibility:

Off/On

Testing electromagnetic compatibility (EMV test)

- i The EMV test may only be performed by certified service technicians.
- To perform the electromagnetic compatibility test, select "on" (3) in the "EMV Test" selection menu.
- To return to the previous submenu, tap BACK (1).
- To return to the "Start screen", tap EXIT (2).

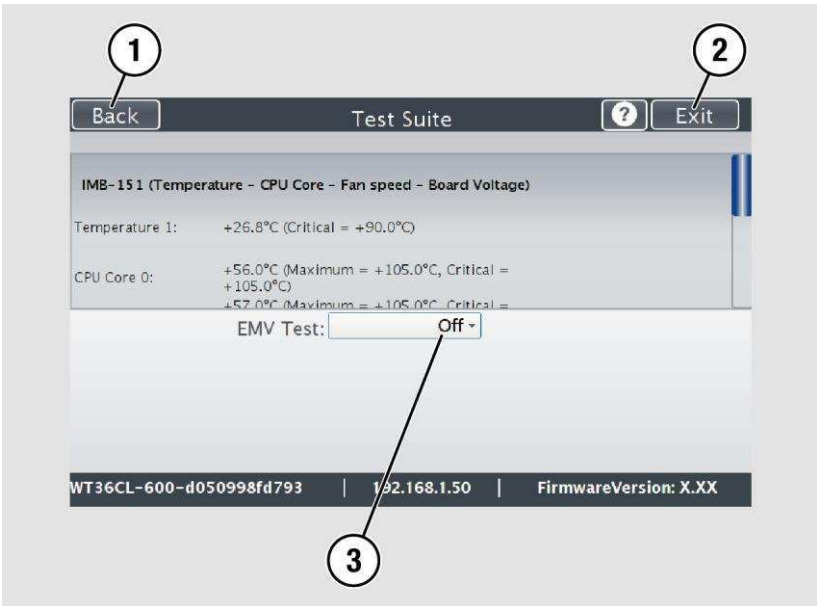

Perform Touchscreen Test

To check the functionality of the touchscreen when touched, proceed as follows:

- On the "Setup Menu" screen tap on TOUCHSCREEN TEST (1).

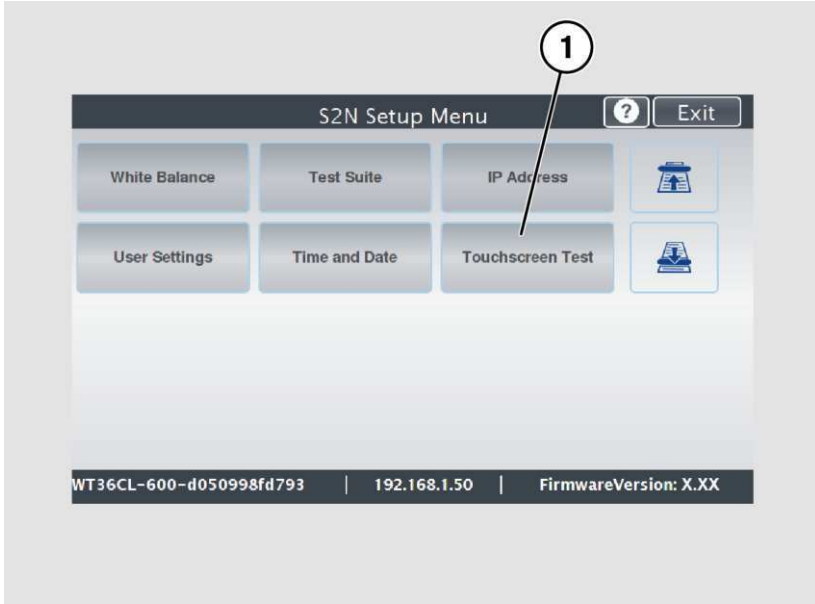

The "Touchscreen Test" screen is displayed.

- To perform the "Touchscreen Test" tap with your finger on the corresponding screen (3).

The crosshairs must occupy the same position as the finger.

- To end the "Touchscreen Test", tap STOP TOUCHSCREEN TEST (1).

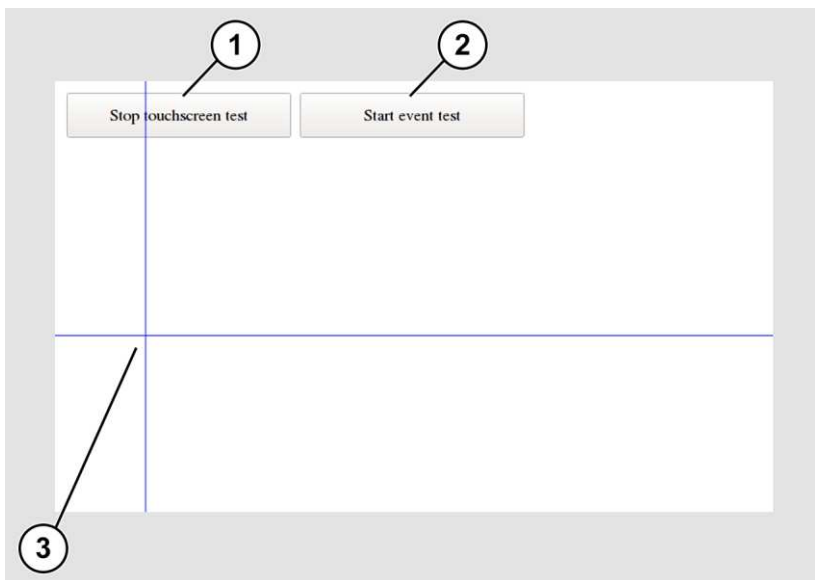

- Tap on START EVENT TEST (2).

The "Event Test" screen is displayed.

The X button (2) cancels the test and returns to the start screen "Touchscreen Test".



- Hold the upper left blinking green rectangle (1) with your finger.
- Wipe your finger from top left to the top right over the touch screen.

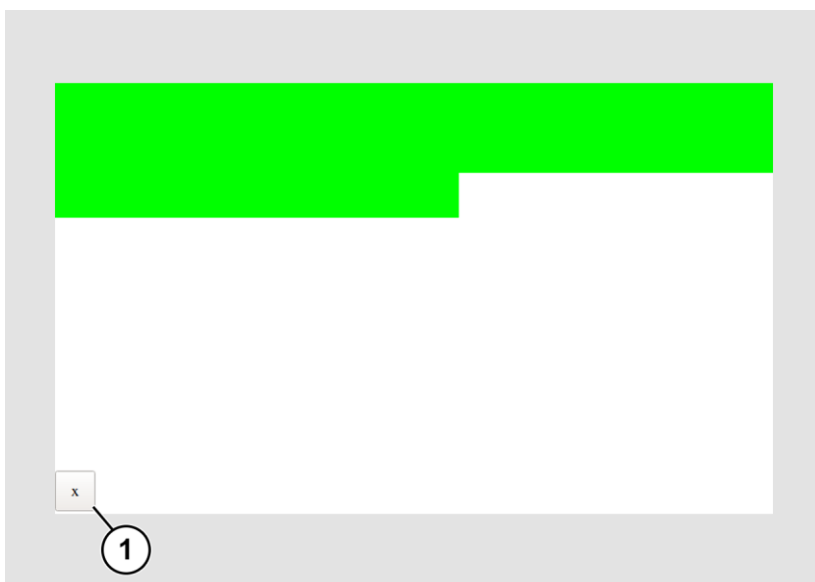

Green rectangles are drawn step by step.

These rectangles mark the area where the "Event Test" has detected the motion events.

- As soon as you arrive at the top right, move down one line and move then to the left again.
- Continue with this procedure until you have reached the lower right edge of the screen.

This test can be aborted at any time by pressing the X (1) button.

If the entire screen is green, the test ends automatically.

The start screen of the "Touchscreen Test" appears.

- To end the "Touchscreen test", tap STOP TOUCHSCREEN TEST (1).

The "Start screen" is displayed.

Height Adjustment (WT60CL)

By adjusting the height setting, your scanner can transport and scan objects with a maximum thickness of 11mm.

Releasing the Height Adjustment

Stand next to the device, facing the right side of the scanner.

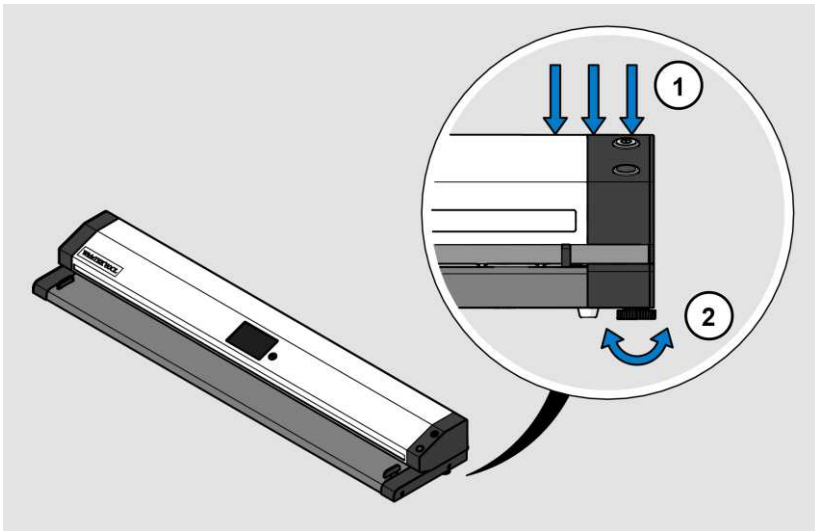

- Press down the upper unit, from above, at the right outer edge, with one hand (1) and hold the pressure firmly.
- Make sure that the upper unit is not inclined in the front or rear transport direction.
- Loosen the right orange adjusting screw (2) with your other hand until the upper unit has moved to the highest position (approx. 10mm).
- Perform the same steps on the left side.

Adjustment of the height setting to the thickness of the object

- Slide the object right through the scanner until it protrudes at the back.
- Press down the upper unit, from above, on the right outer edge, with one hand (1) until it makes contact with the object.
- Fix this position with the orange adjusting screw (2).
- Slide the object left-aligned through the scanner and repeat the same steps.

Verification of height adjustment and document transport

- Place the object in the middle and check the transport by pressing the two document transport buttons on the operating screen.

The object should move straight and without resistance evenly back and forth.

- The object must always be supported by the user.

This applies to both the feed and the ejection at the end of the scanning process.

If the object turns to the left during transport, the pressure on the right side is too low.

If the object rotates to the right, the pressure on the left side is too low.

- Change the pressure on the object with the two adjusting screw (2).

If the object cannot be moved forwards or backwards or if it gets stuck on the back side, the overall pressure is too high.

Test Scan

- Now insert the object back into the device for a scan.
- In ScanWizard, in the "Transport / Transport Speed" menu, select the "Thick Media" function.
- Start a scan.

The height adjustment setting was successful if during the scan process, the document, was transported without resistance and the generated image does not show any image errors.

Recovery

Hard Disk / Solid State Disk Software Failure

The file system and the Linux operating system of a Scan2Net scanner are very robust and forgiving. The file system has the ability to repair itself, even if the system loses power during a disk write operation, a condition which will almost certainly corrupt any Windows, Android or MAC OS based computer.

Nevertheless, under certain circumstances it might happen that the Scan2Net Linux software on the HD/SSD becomes corrupt. Unexpected power failures, hard power off cycles via the main power switch without a previously controlled shut down and other unexpected terminations of the operating system may cause this kind of failure. Also, any uncontrolled interrupt of a firmware update procedure or other functions which involve writing to the main storage (HD or SSD) are a potential risk to the integrity of the firmware on the HD/SSD. The Scan2Net operating system of every WideTEK® or Bookeye® scanner is Linux based and although it happens very rarely, the Linux operating system can be corrupted like any other operating system; whether it is a Windows, Android, Mac or any other OS. If the Linux operating system or other parts of the HD/SSD are corrupted, there is still no need to replace the HD/SSD, at least not before the recovery procedure is executed once. This procedure is similar to the procedures necessary to restore a Windows, Android or Apple OS to a previous state.

Recover the HD/SSD to Factory Default

In a Scan2Net® scanner, an image of the Scan2Net Linux is stored on the Recovery Partition at certain times. The image is generated at the time of manufacturing, and also at all times when an HD/SSD needed to be replaced.

Preparations to Recover an HD/SSD



- Make sure that you know the scanner's IP address, subnet and gateway valid for the network or have the network administrator available.
- Login to the Image Access Customer Service Portal at <http://portal.imageaccess.de> and obtain the latest firmware for your device.

Step	Action
1	<p>If still possible, shut down the scanner, either through the touch panel or through the currently used application or by pushing the start button on the scanner's housing.</p> <p>Otherwise, switch off the scanner at its main power switch.</p>

Recovery Process





Make sure that the following process is not interrupted by a hard shut down or power failures.
If this process is interrupted, a loss of the recovery partition is possible, making it mandatory to physically replace the HD/SSD.



The following process cannot be influenced by the user.

Recovery Process 1



Most scanners come with a recovery key, some newer scanners (such as WideTEK 36CL-MF or WideTEK 60CL) come with a STOP button which can be used to replace the recovery key.

Recovery Key	STOP Button
	
<p>The Recovery Key, shown above, is an accessory included with many scanners and can be used to invoke the recovery procedure.</p>	<ol style="list-style-type: none"> 1 STOP button 2 POWER button

The recovery procedure is a simple multistage process.

Step	Action
2.1 - Scanner with recovery key	Wait until the scanner has powered down, then plug in the recovery key to the DB9 connector on the rear side of the scanner.
2.2 - Scanner with STOP button	Wait until the scanner has powered down.
3 - All scanners	Make sure that the main power is switched on.
4.1- Scanners with recovery key	Power up the scanner via the POWER button.
4.2 - Scanners with STOP button	<p>Press and hold the red STOP button (1) before switching ON.</p> <p>Power up the scanner via the POWER button.</p> <p>Important: The red STOP button (1) must be pressed and then held until the red button starts to light up permanently.</p>

Step	Action
5 - All scanners	<p>The recovery procedure starts automatically.</p> <p>It replaces the corrupted content of the Scan2Net Linux partition with the content of the recovery partition.</p> <p>This process takes about 10 - 15 minutes.</p> <p>At the end, it powers down the scanner.</p>
6 - All scanners	Wait until the scanner has powered down.
7 - All scanners	Switch it off via the main power switch.
8 - Scanners with recovery key	Remove the recovery key from the connector on the rear side of the scanner.
9 - All scanners	Switch on the scanner via its main power switch.
10 - All scanners	Power up the scanner via the start button.

-  After this procedure is complete, all network credentials are lost. Important: The default IP address is now reset to the factory default 192.168.1.50!
-  To set up your own network configuration, please refer to the chapter Assign the IP Address in this Setup and Instructions manual.

Recovery Process 2 - Update Scanner Firmware

Step	Action
11	In case the currently installed firmware of the scanner is not the latest version, connect the scanner via a web browser.
12	Select "Setup Device".
13	Login in as "Poweruser" with the user name "Poweruser" and the corresponding password. Default password is "Poweruser".
14	Select "Updates & Uploads".
15	In the section "Update Scanner Firmware", update the scanner with the firmware version you downloaded from the Customer Service Portal.

Recovery Process 3 - Adjustments

Finally, it is required to perform a few adjustments.

-  Note: All scanners require that you at least adjust the White Balance.
- Please refer to the Perform Setup chapter in the Setup & Instructions manual of your scanner for the necessity of further adjustments.

End of recovery process.

Technical Specifications

Scanner Specification

Optical System WideTEK® 36CL-600

Document width	965 mm (38 inches)
Scan width	915 mm (36 inches)
Scan direction	Face up
Scanner resolution	1200 × 1200dpi (optionally 9600 × 9600 dpi interpolated)
Pixel dimension	42 x 42µm
Sensor type	Three dual light CIS modules
Color Depth	48 bit color (internal resolution) 16 bit grayscale (internal resolution)
Scan modes	24 bit color, 8 bit color indexed, 8 bit grayscale bitonal, enhanced halftone
File formats	Multipage PDF (PDF/A) and TIFF, JPEG, JPEG 2000, PNM, PNG, BMP, TIFF (Raw, G3, G4, LZW, JPEG), AutoCAD DWF, JBIG, DjVu, DICOM, PCX, Postscript, EPS, Raw data

Optical System WideTEK® 48CL-600

Document width	1270 mm (50 inches)
Scan width	1220 mm (48 inches)
Scan direction	Face up
Scanner resolution	1200 × 1200dpi (optional 9600 × 9600 dpi interpolated)
Pixel dimension	42 x 42µm
Sensor type	Four dual light CIS modules
Color depth	48 bit color (internal resolution) 16 bit grayscale (internal resolution)
Scan modes	24 bit color, 8 bit color indexed, 8 bit grayscale bitonal, enhanced halftone
File formats	Multipage PDF (PDF/A) and TIFF, JPEG, JPEG 2000, PNM, PNG, BMP, TIFF (Raw, G3, G4, LZW, JPEG), AutoCAD DWF, JBIG, DjVu, DICOM, PCX, Postscript, EPS, Raw data

Optical System WideTEK® 60CL-600

Document width	1524 mm (60 inches)
Scan width	1570 mm (61.85 inches)
Scan direction	Face up
Scanner resolution	1200 × 1200dpi (optional 9600 × 9600 dpi interpolated)
Pixel dimension	42 x 42µm
Sensor type	Five dual light CIS modules
Color depth	48 bit color (internal resolution) 16 bit grayscale (internal resolution)
Scan modes	24 bit color, 8 bit color indexed, 8 bit grayscale bitonal, enhanced halftone
File formats	Multipage PDF (PDF/A) and TIFF, JPEG, JPEG 2000, PNM, PNG, BMP, TIFF (Raw, G3, G4, LZW, JPEG), AutoCAD DWF, JBIG, DjVu, DICOM, PCX, Postscript, EPS, Raw data

Ambient Conditions

Operation temperature	+5 to +40 °C (40 to 105F)
Storage temperature	0 to + 60°C (32 to 140 F)
Relative humidity	20 to 80 % (non-condensing)
Noise level	≤ 35 dB(A) (Operating) ≤ 25 dB(A) (Standby)

Electrical Specifications

External Power Supply

Voltage	100–240 Vac
Frequency	47–63 Hz
ECO standard	CEC Level VI

Scanner

Voltage	19 Vdc
Current	3 A

Power Consumption

Sleep	≤ 0,5 W
Standby	approx. 5 W
Ready to scan	< 25 W
Scanning	< 45 W

Document Specification

Document length	up to 500 m (20.000 inch) ¹
Paper grade	any
Document thickness	2,5 mm (0,1 inch) max. (WT36CL/WT48CL) 11,0 mm (0,4 inch) max. (WT60CL)

¹(E.g. Canvas up to max. 100 mm in a frame up to 200 mm thickness).

Dimensions and Weight WideTEK® 36CL-600

Scanner outer dimensions (H x W x D)	170 x 1088 x 358 mm (6.7 x 42.8 x 14.1 inches)
Weight of scanner	24 kg (53 lbs.)
Weight of floor stand	19 kg (42 lbs.)
Transport box dimensions (scanner) (H x W x D)	260 x 1160 x 440 mm (10.2 x 45.7 x 17.3 inches)
Transport box dimensions (floor stand) (H x W x D)	145 x 1100 x 260 mm (5,7 x 43,3 x 10,2 inches)
Scanner weight, ready to ship	32 kg (70.5 lbs.)
Floor stand weight, ready to ship	21 kg (46 lbs.)

Dimensions and Weight WideTEK® 48CL-600

Scanner outer dimensions (H x W x D)	170 x 1418 x 358 mm (6.7 x 55.8 x 14.1 inches)
Weight of scanner	28,5 kg (63 lbs.)
Weight of floor stand	19 kg (42 lbs.)
Transport box dimensions (scanner) (H x W x D)	250 x 1490 x 440 mm (9.8 x 58.7 x 17.3 inches)
Transport box dimensions (floor stand) (H x W x D)	1400 x 270 x 150 mm (55.1 x 10.7 x 5.9 inches)
Scanner weight, ready to ship	34.5 kg (76 lbs.)
Floor stand weight, ready to ship	21 kg (46.3 lbs.)

Dimensions and Weight WideTEK® 60CL-600

Scanner outer dimensions (H x W x D)	170 x 1697 x 358 mm (6.7 x 66.8 x 14.1 inches)
Weight of scanner	35 kg (75 lbs.)
Weight of floor stand	21 kg (46 lbs.)
Transport box dimensions (scanner) (H x W x D)	250 x 1780 x 440 mm (9.8 x 67 x 17.3 inches)
Transport box dimensions (floor stand) (H x W x D)	250 x 1780 x 440 mm mm (9.8 x 67 x 17.3 inches)
Scanner weight, ready to ship	39.5 kg (87 lbs.)
Floor stand weight, ready to ship	31.5 kg (69 lbs.)

End of document

