



WideTEK® 36DS



Setup Instructions English

03/2017

Contents

Information about the Instructions and the Manufacturer	4
Keep Instructions with the Scanner	4
Design Features in Text.....	5
Design Features in Pictures.....	5
Associated Documents	6
Copyright	6
Contact Data of the Manufacturer in Germany.....	6
Technical Support	6
Contact Data of the Manufacturer in the U.S.....	6
Safety.....	7
Intended Use	7
Basic Safety Information.....	7
Avoiding Property Damage and Malfunctions.....	8
Responsibility of the Owner	9
Staff Qualifications.....	9
Design Features of Warning Notices	10
Formatting of Information Regarding Property Damage.....	10
Description	11
Purpose and Function	11
WideTEK® 36DS Overview	11
Left View	12
Rear View	13
Self Test Menu Overview Screens	14
Rating Plate.....	16
Prepare for Setup.....	17
Connect the Power Supply	17
Establish the Network Connection	17
Positioning the Scanner on the Optional Floor Stand.....	18
Connect the Optional Foot Switch.....	18

Connect the Optional Monitor	19
Switch On the Scanner	20
Switch Off the Scanner	22
Perform Setup	24
Activate the Setup Menu.....	24
Assign the IP Address	25
Perform White Balance	33
Lamp On/Off.....	37
Touch Adjust.....	37
Touch Test	38
Stitch Test	39
EMV Test	39
Sensor Test	39
Shutdown Scanner.....	40
Technical Specifications	41
WideTEK® 36DS Scanner Specification	41
Ambient Conditions.....	42
Electrical Data.....	43
Document specifications	43
Dimensions and Weight WideTEK® 36DS	44

Information about the Instructions and the Manufacturer

These instructions show you how to safely prepare and perform the setup for the wide format scanner WideTEK® 36DS. The WideTEK® 36DS scanners are hereinafter referred to as "Scanner".

Keep Instructions with the Scanner

These instructions are a part of the scanner.

- Please always store these instructions together with the scanner.
- Ensure that the instructions are available for the user.
- Enclose the instructions when you sell the scanner or transfer it in any other way.

Design Features in Text

Many text passages in these instructions have been formatted to indicate specific elements, as illustrated below:

Normal text

BUTTONS OF THE SCREEN PAGE

"Menu names"

➤ Action steps

• Enumeration of the first level

Cross-references

 Tips contain additional information, such as special information to prepare for and perform the setup.

Design Features in Pictures

Where a reference is made to elements in a legend or in the text, these are marked with a number (1).

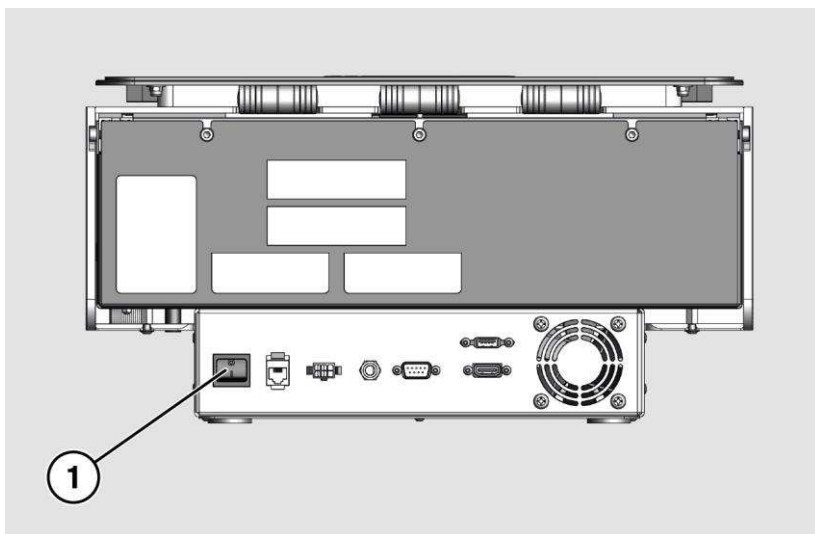

Associated Documents

In addition to these instructions, other documents associated with the operation of the scanner include:

- Unpacking and Repacking Instructions
- Legal Information (Declarations of Conformity, FCC Declaration, Safety & EMI Certificates, RoHS etc.).

Copyright

These instructions contains information that is subject to copyright. These instructions may not be reproduced in any form, printed, filmed, edited, copied or distributed, in whole or in part, without prior written permission from Image Access GmbH.

© Image Access GmbH 2017

All rights reserved.

Contact Data of the Manufacturer in Germany

Image Access GmbH

Hatzfelderstraße 161-163

42281 Wuppertal

Phone: +49-202-27058-0

E-Mail: documentation@imageaccess.de

Internet address: www.imageaccess.de

Technical Support

Image Access technical support can be reached at the e-mail address: support@imageaccess.de.

Contact Data of the Manufacturer in the U.S.

Image Access LP

745 Duffy Drive, Unit D

Crystal Lake

IL 60014

Phone: +1-779-220-4662

E-Mail: support@imageaccess.us

Internet address: www.imageaccess.us

Safety

Intended Use

The scanner is used for scanning images and documents. The documents must comply with the characteristics described in the technical specifications. The scanner is designed for use in enclosed spaces in the commercial sector.

Intended use also includes observing and following all information provided in these instructions, especially the safety instructions. Any other use is considered to be improper and will void the warranty and liability claims.

Ambient Conditions

Ensure that the scanner is used exclusively under the following environmental conditions:

- Ambient temperature during operation: +5 °C to +40 °C
 - Storage temperature: 0 °C to +60 °C
 - Relative humidity: 20 to 80%, non-condensing
- Ensure that the scanner is not exposed to direct sunlight.

Basic Safety Information

Avoid Injury or Death by Electric Shock

- Never open the housing of the scanner.
- Do not expose the scanner to dripping or splashing water and do not place any vessel filled with liquid on the scanner. Penetrating liquid can damage the scanner.
- Do not insert objects through existing slots or openings into the interior of the scanner.

- Only connect the scanner with the plug of the supplied AC adapter to a professionally installed and grounded outlet.
- Do not use the AC adapter if the power supply's housing or the cable are damaged. In this case, replace the power supply with a power supply of the same type.
- Do not use the scanner if it is visibly damaged. In this case, unplug the power cord from the wall outlet. Contact Image Access technical support, see section *Technical Support* starting at page 6.

Avoid Burns

- Do not cover the existing openings in the scanner housing. They serve to ventilate. Covering the openings could cause overheating.
- Do not place the scanner in front of air conditioning units, which produce high heat.

Avoid Fractures, Contusions and Bruises

Incorrect installation of the cables can cause tripping.

- Lay the connecting cables so that no one can trip over them.

The scanner weighs 64 kg.

- Only carry the scanner with a second person.
- Place the scanner only on a stable, level and vibration-free surface that has sufficient strength for the weight of the scanner.

Avoiding Property Damage and Malfunctions

- Ensure adequate ventilation to comply with the environmental conditions.
- Do not place the scanner in the vicinity of devices that emit strong electromagnetic radiation.
- Always place the scanner on a suitable, stable table or the optional floor stand.
- Do not lean on the scanner.
- Ensure that the thickness of the material to be scanned does not exceed 2,5 mm.
- Do not use any cleaning agents containing abrasive additives, solvents or acids. Use a damp microfiber cloth.
- Operate the touchscreen only with your finger. Other objects can damage the touchscreen.

Responsibility of the Owner





The scanner owner must ensure that only qualified personnel carry out the setup of the scanner.

Staff Qualifications



The staff that carries out the setup of the scanner must have knowledge in installing, connecting and putting computer accessories into operation.

Design Features of Warning Notices

In these instructions, the following warning information can be found:

 WARNING	
	Notices with the word WARNING warn about a dangerous situation that could lead to death or serious injuries.
 CAUTION	
	Notices with the word CAUTION warn about a situation that could lead to light or medium-scale injuries.

The following symbols are used in the warnings:

Symbol	Explanation
	Danger from electrical shock
	General danger symbol

Formatting of Information Regarding Property Damage

ATTENTION!	
	These notices warn of situations that can lead to property damage.

Description

Purpose and Function

The scanner is used for scanning images and documents. It is designed for use in enclosed spaces in the commercial sector. Intended use also includes observing and following all instructions in these instructions, especially the safety instructions. Any other use is considered to be improper and will void the warranty and liability claims.

WideTEK® 36DS Overview

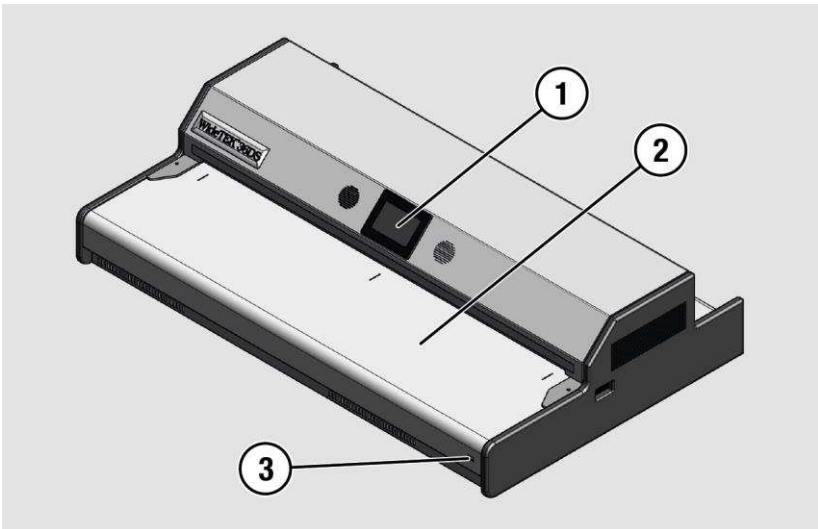

No.	Name
1	Document transport
2	Touchscreen
3	USB connector

Left View

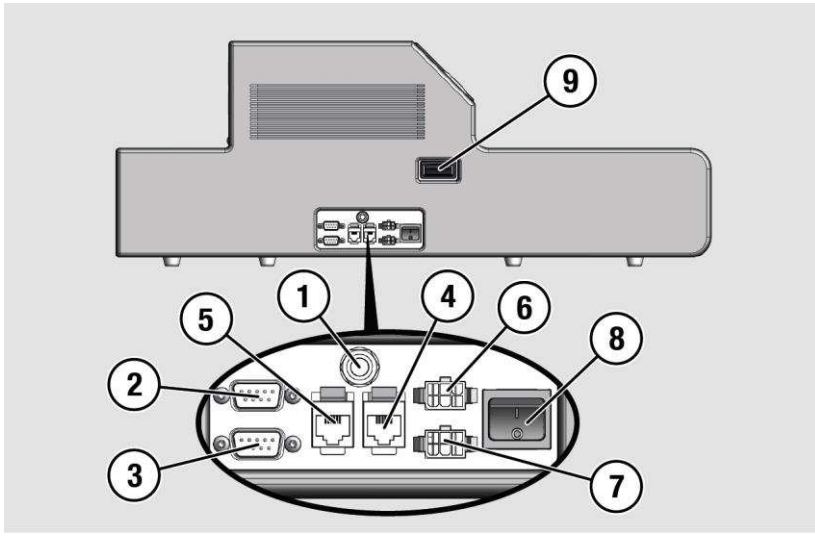

No.	Name
1	Foot switch connector
2	Recovery key connector F
3	Recovery key connector B
4	Network connector F
5	Network connector B
6	24 Vdc connector for external power supply F
7	24 Vdc connector for external power supply B
8	Main switch
9	Locking flap

Rear View

The following diagram shows the rear view of the WideTEK® 36DS model.

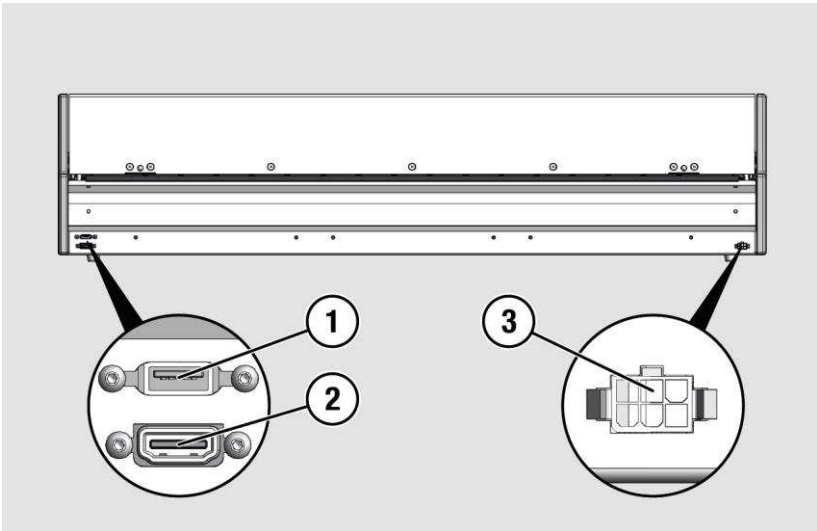

No.	Name
1	USB connector
2	HDMI connector
3	Connector for external accessories

Self Test Menu Overview Screens

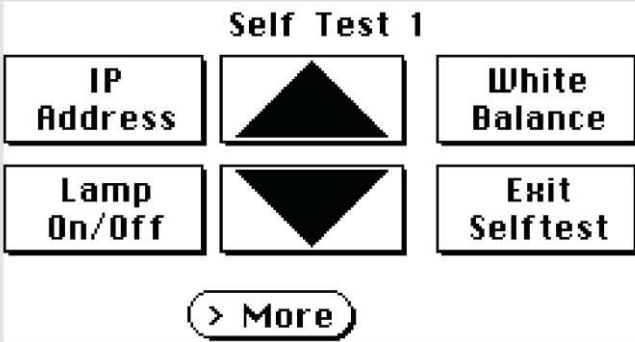

Menu and Buttons	Name
SELF TEST 1	Menu name
IP ADDRESS	Button for network configuration
▲	Button to drive the document forward in the scanner
WHITE BALANCE	Button for white balance
LAMP ON/OFF	Button for lamp test
▼	Button to drive the document backward in the scanner (rewind)
EXIT SELFTEST	Button to leave the Self Test mode to the start screen
> MORE	Button to switch to "Self Test 2" menu

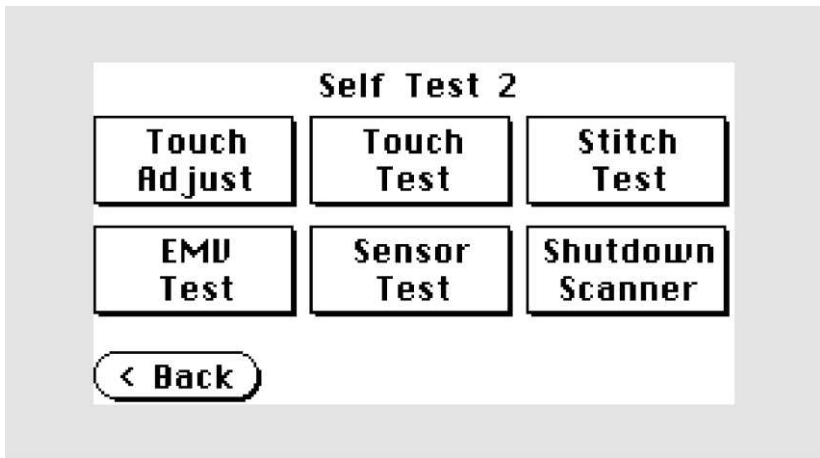

Menu and Buttons	Name
SELF TEST 2	Menu name
TOUCH ADJUST	Button for touch adjust
TOUCH TEST	Button for touch test
STITCH TEST	Button for stitch test
EMV TEST	Button for EMV test
SENSOR TEST	Button for sensor test
SHUTDOWN SCANNER	Button to switch the scanner into standby mode
< BACK	Button to return to "Self Test 1" menu

Description

Rating Plate

The rating plate is attached to the back of the scanner.

The following figure shows the WideTEK® 36DS rating plate.

Type/品类: **Wide F. Scanner/大幅面扫描仪**

Model/型号: **WT36DS-600**

Volt/电压: **2*24DC** Amperes/电流: **2*5**



Self Declaration: Conforms to IS 13252 (Part 1):2010, R-41006580

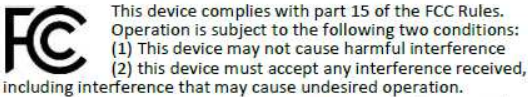





Made in Germany 德国制造

Image Access GmbH, Wuppertal
www.imageaccess.de

Serial #./Manufacturing Date on Barcode Label

Prepare for Setup



Connect the Power Supply

 WARNING	
	<p>Risk of electric shock due to incorrect connection.</p> <ul style="list-style-type: none"> ➤ Ensure that the power receptacles intended for the connection are properly grounded. ➤ Ensure that the power receptacles intended for the connection of the scanner are properly fused.
 CAUTION	
	<p>Incorrect laying of the connection cables can cause tripping. Fractures, contusions and bruises can be the result.</p> <ul style="list-style-type: none"> ➤ Place the connecting cables so that nobody can trip over them.

To connect the power supplies, proceed as follows:

- Make sure that the main switch of the scanner is switched off (0 position).
- Use only the AC adapters and power cords supplied.
- Ensure the power cords are not damaged.
- Connect the connectors from the power supplies to the associated 24 Vdc connectors on the left of the scanner.
- If not already done, connect the supplied power cables to the associated connectors on the power supplies.
- Connect the power plugs of the power supplies to power receptacles of the correct voltage (100-240 Vac).

Establish the Network Connection

 CAUTION	
	<p>Incorrect laying of the connection cables can cause tripping. Fractures, contusions and bruises can be the result.</p> <ul style="list-style-type: none"> ➤ Place the connecting cables so that nobody can trip over them.

To establish the network connections, proceed as follows:

- Connect one plug of the enclosed network cables to the network connector sockets on the left of the scanner.
- Connect the second plugs to the network sockets of an existing network.

Positioning the Scanner on the Optional Floor Stand

CAUTION



The scanner weighs 64 kg.

- Only carry the scanner with a second person.
- Ensure that the scanner is secured so that it does not fall over.

To position the scanner on the optional floor stand, proceed as follows:

- Assemble the floor stand according to the floor stand assembly instructions.
- Position the scanner on the floor stand as described in the accompanying floor stand assembly instructions.

Connect the Optional Foot Switch

CAUTION



Incorrect laying of the connection cables can cause tripping. Fractures, contusions and bruises can be the result.

- Place the connecting cables so that nobody can trip over them.

To connect the optional foot switch, proceed as follows:

- Connect the plug of the foot switch to the connector socket for the foot switch, located on the left of the scanner.

Connect the Optional Monitor

CAUTION



Incorrect laying of the connection cables can cause tripping. Fractures, contusions and bruises can be the result.

- Place the connecting cables so that nobody can trip over them.

To connect the optional monitor, proceed as follows:

- Connect the HDMI connector plug of the monitor to the HDMI connector socket, located on the back of the scanner.

Switch On the Scanner

To switch on the scanner, proceed as follows:

- Press the MAIN SWITCH (1) to the "I" position.

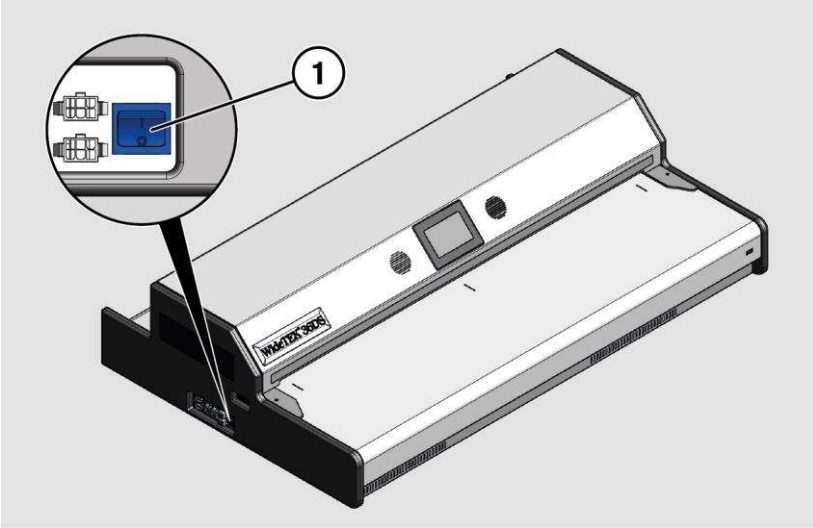

The scanner is in standby mode. The touch panel is illuminated in a dimmed mode and shows the standby screen. The standby screen shows the Image Access logo and the blinking message Touch screen to power up.

To start the scanner from standby mode, proceed as follows:

➤ Touch the touchscreen.

The touch panel lights up and a rotating hourglass indicates that the start sequence is running.

The scanner performs a system test.

After a short wait, the "Start screen" is displayed.

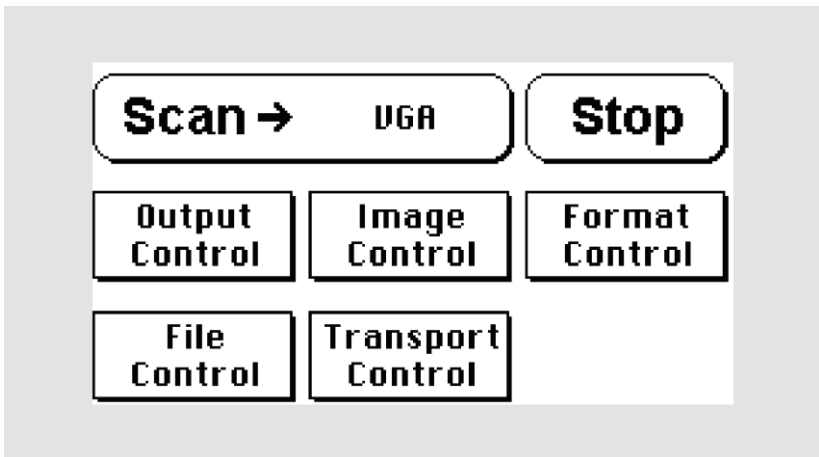

Switch Off the Scanner

To switch the scanner to standby mode after performing the setup, proceed as follows:

- On the "Start screen" screen press and hold the button STOP (1).

While STOP is being held, a counter in the button displays the time until the scanner is switched into standby mode: "Going to sleep in x seconds".

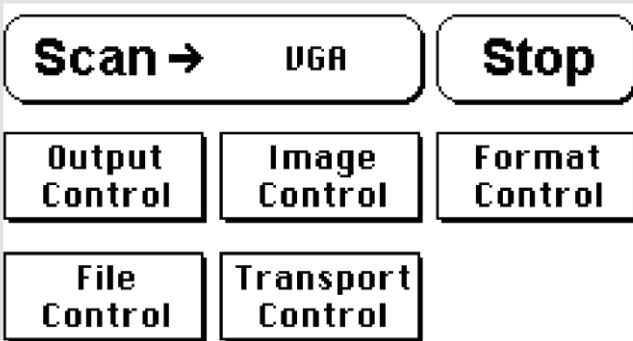

The scanner shuts down. This process can take up to 40 seconds.

At the end of the process the display will be dimmed.

- ✓ The scanner is in standby mode.

To switch off the scanner for longer periods, proceed as follows:

- Make sure that the scanner is in standby mode.
- Press the MAIN SWITCH (1) in the "0" position.

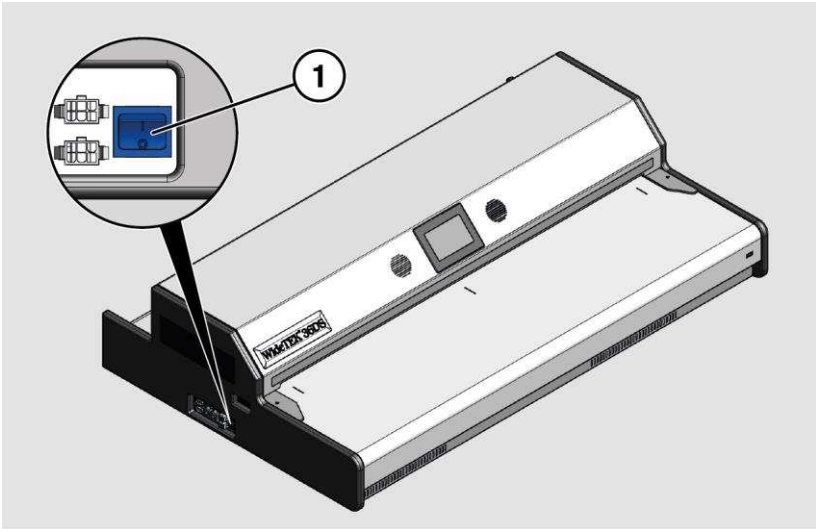

Perform Setup

Activate the Setup Menu

To activate the setup menu proceed as follows:

- During the start sequence tap exact three times onto the touchscreen (1).
 - ✓ At the end of the start sequence the touchscreen shows the "Self Test 1" screen.

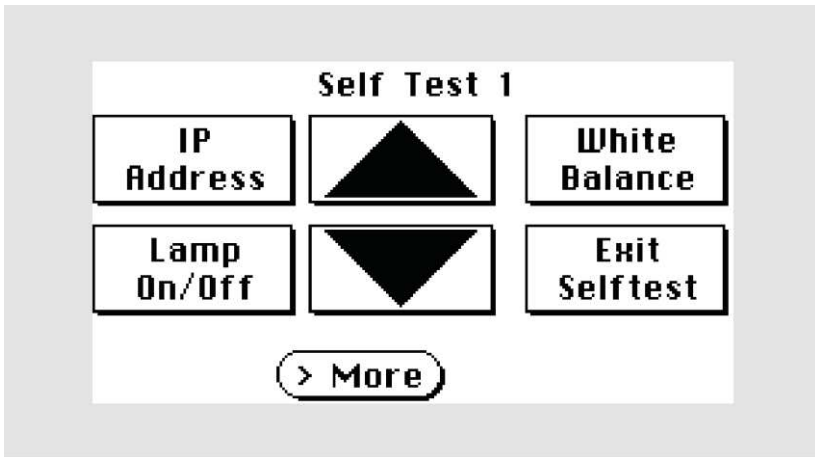

Menu and Buttons	Name
SELF TEST 1	Menu name
IP ADDRESS	Button for network configuration
▲	Button to drive the document forward in the scanner
WHITE BALANCE	Button for white balance
LAMP ON/OFF	Button for lamp test
▼	Button to drive the document backward in the scanner (rewind)
EXIT SELFTEST	Button to leave the Self Test mode to the start screen
> MORE	Button to switch to "Self Test 2" menu

- To select a submenu or a function from the screens "Self Test 1" and "Self Test 2", tap with your finger on the button of the screen.

Assign the IP Address

Manually Assign the IP Address

To manually assign the IP address, proceed as follows:

- On the "Self Test 1" screen, tap on IP ADDRESS.

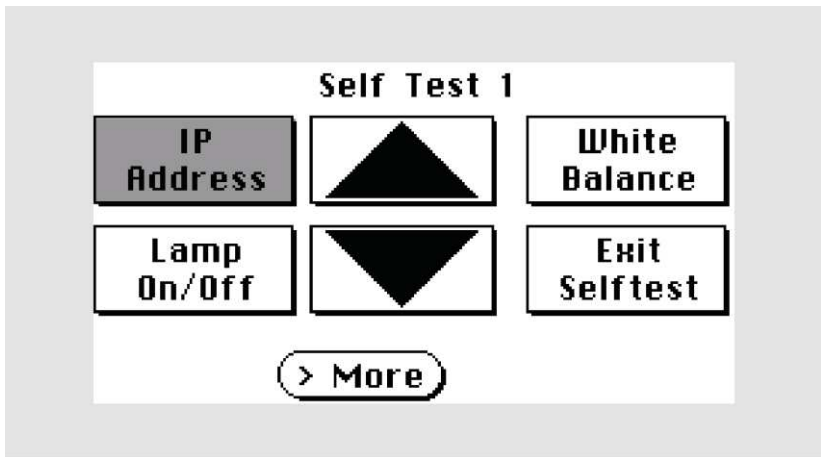

The "IP Address 1" screen is displayed.

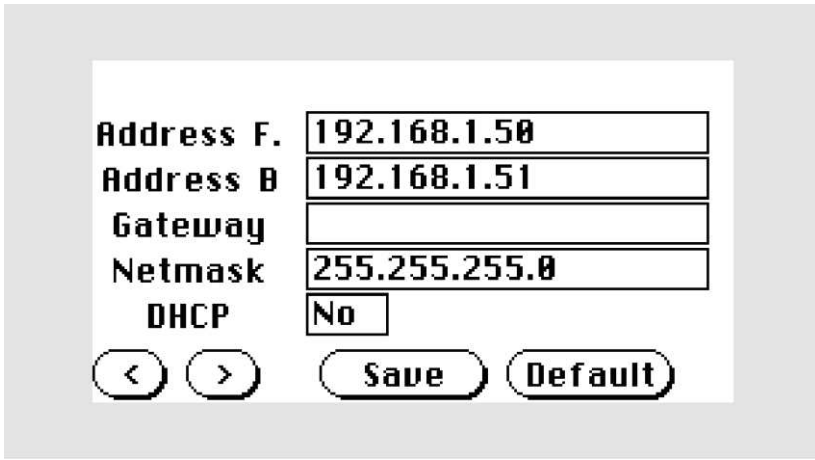

Menu and Buttons	Name
ADDRESS F.:	The IP address for the front camera
ADDRESS B.:	The IP address for the back camera
GATEWAY:	Input field for the gateway address
NETMASK:	Input field for data on the subnet mask
DHCP:	Assign an IP address manually or automatically
SAVE:	Accept the network settings provided
DEFAULT:	Reset to factory settings
<	Back to "Self Test 1" menu
>	Switch to "IP Address 2" menu

➤ Tap the ADDRESS F entry field.

The "IP Address" window is displayed.

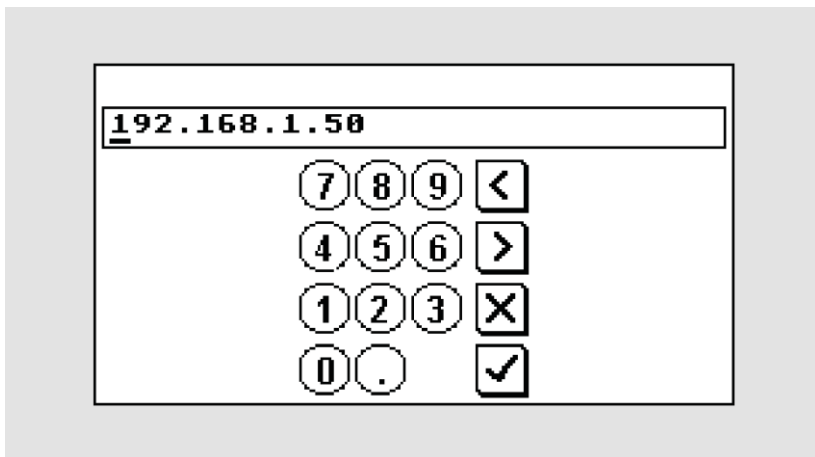

➤ Enter the new values with the shown numeric keyboard.

The arrow keys < = left (1) and > right (2) move the cursor within the chosen row.

The X key deletes the number at the cursor position.

➤ To finalize the input, tap on the CHECKMARK key.

The "IP Address" window will be closed.

The "IP Address 1" screen is displayed.

➤ Perform the settings for gateway and subnet mask in the same way.

➤ Switch with > to "IP Address 2".

The screen "IP Address 2" is displayed.

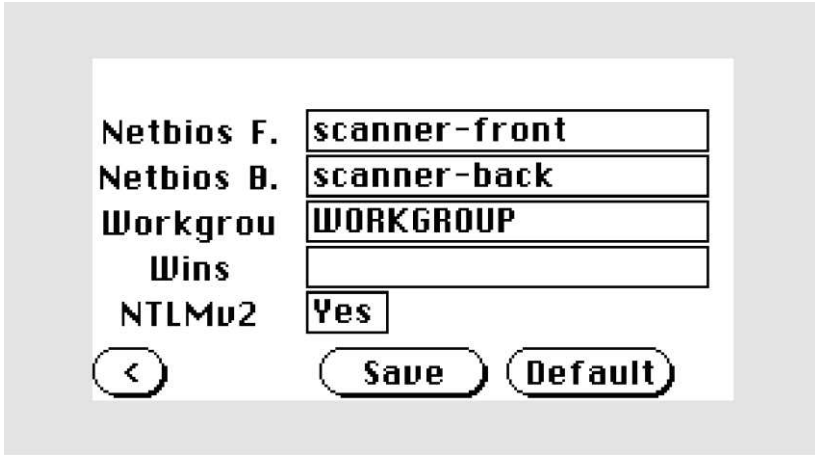

Menu and Buttons	Name
NETBIOS F.:	Netbios data for the front camera
NETBIOS B.:	Netbios data for the back camera
WORKGROUP:	Workgroup name
WINS:	Wins data
NTLMv2:	Use of NTLMv2 (NT LAN Manager): Yes / No
SAVE:	Accept the network settings provided
DEFAULT:	Reset to factory settings
<	Switch to "IP Address 1" menu

If entries have been changed, the changes must be confirmed.

- Tap on SAVE to confirm the changes.

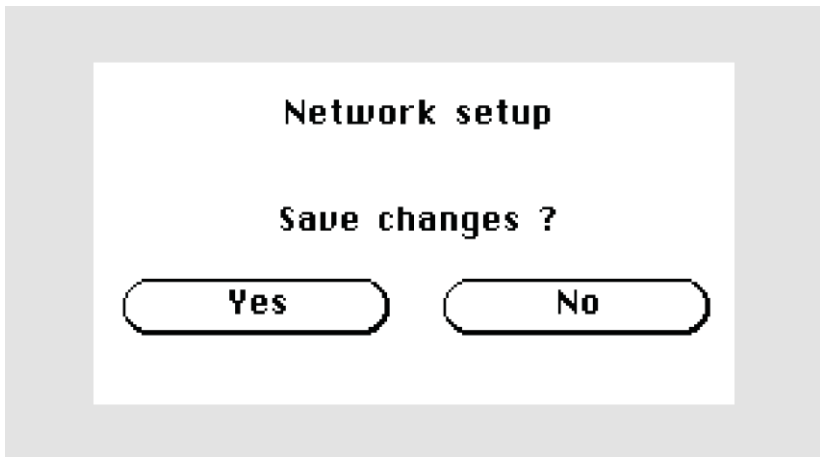

- YES save the changes.
- NO discards the changes.

After the changes have been saved, the "Self Test 1" screen is displayed again.

<i>ATTENTION!</i>	
	<p>The IP addresses 10.254.254.50 and 10.254.254.51 can not be used as IP network addresses for the scanner, because they are already set up for the internal communication. These IP addresses can not be changed.</p> <ul style="list-style-type: none">➤ Contact Image Access technical support, see section Technical Support starting at page 6.

Automatically Assign the IP Address

To automatically assign the IP address, proceed as follows:

- On the "Self Test 1" screen, tap on IP ADDRESS.

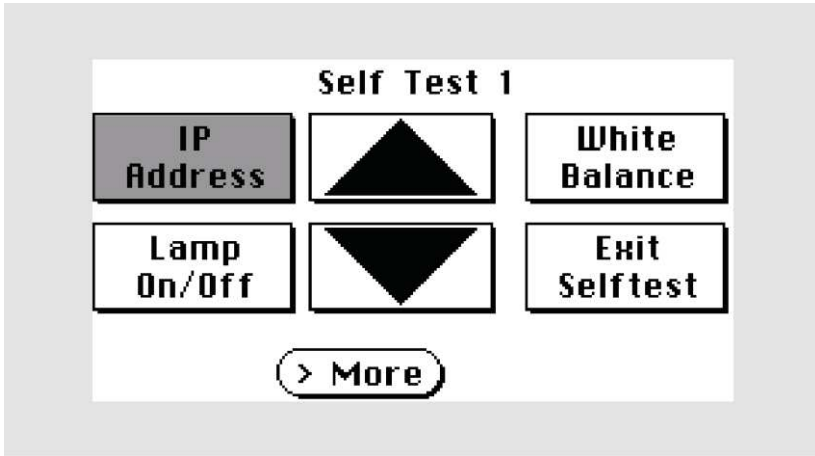

The "IP Address 1" screen is displayed.

Menu and Buttons	Name
ADDRESS F.:	The IP address for the front camera
ADDRESS B.:	The IP address for the back camera
GATEWAY:	Input field for the gateway address
NETMASK:	Input field for data on the subnet mask
DHCP:	Assign an IP address manually or automatically
SAVE:	Accept the network settings provided
DEFAULT:	Reset to factory settings
<	Back to "Self Test 1" menu
>	Switch to "IP Address 2" menu

Address F.	192.168.1.50
Address B	192.168.1.51
Gateway	
Netmask	255.255.255.0
DHCP	No

< > Save Default

- Tap the DHCP selection field and select Yes.
The displayed entry in the DHCP selection box changes to Yes.
If entries have been changed, the changes must be confirmed.
- Tap on SAVE to confirm the changes.

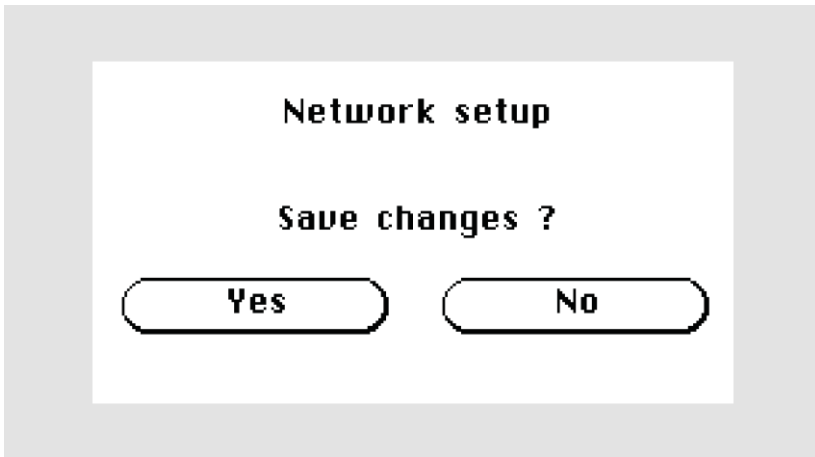

- YES save the changes.
- NO discards the changes.

After the changes have been saved, the "Self Test 1" screen is displayed again.

ATTENTION!	
	<p>The IP addresses 10.254.254.50 and 10.254.254.51 can not be used as IP network addresses for the scanner, because they are already set up for the internal communication. These IP addresses can not be changed.</p> <ul style="list-style-type: none">➤ Contact Image Access technical support, see section Technical Support starting at page 6.

Perform White Balance

- On the "Self Test 1" screen, tap on WHITE BALANCE.

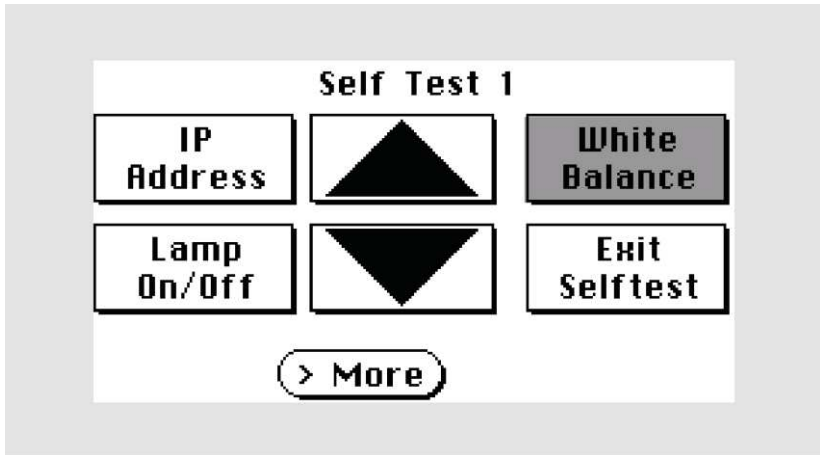

The "White Balance" screen is displayed.

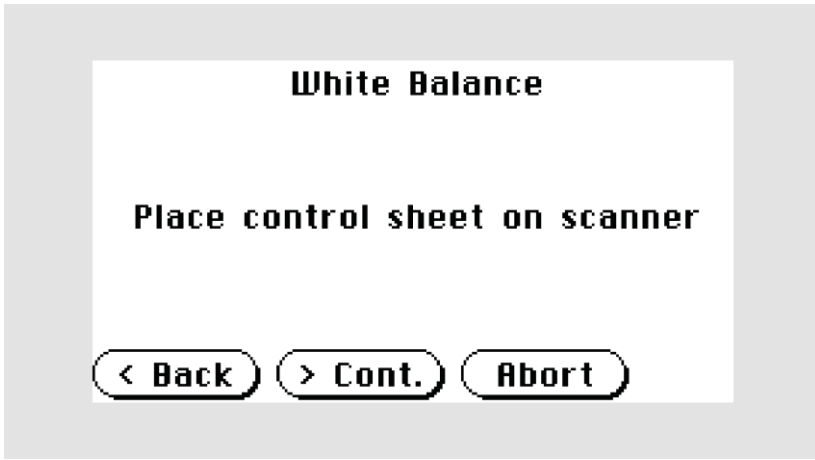

Menu and Buttons	Name
WHITE BALANCE	Menu name
CONT.	Start white balance
ABORT	Abort white balance
< BACK	Switch back to "Self Test 1" menu

The white balance is used to ensure the quality of the scan results. The white balance will be carried out using a test target. The test targets are marked as follows:

- WT36C-Z-01-A for WideTEK® 36DS

ATTENTION!

Impairment of the scan quality can occur if an improper test target for the white balance is used.

- Make sure that the test target is free from wrinkles, discolorations, cracks or other damage.
- Store the test target for the white balance in a safe place protected from daylight.

To perform the white balance, proceed as follows:

- Position the supplied test target (1) in the document transport as illustrated below (2).

The test target (1) is pulled into the scanner.

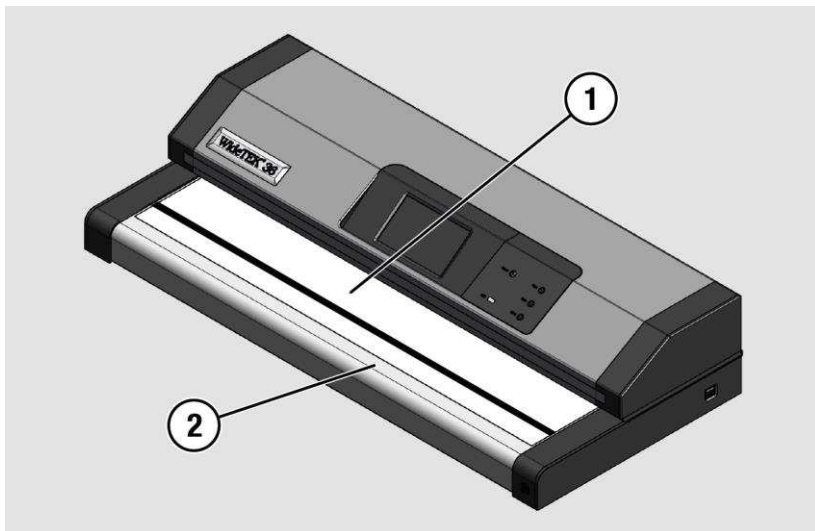

➤ Tap on Cont..

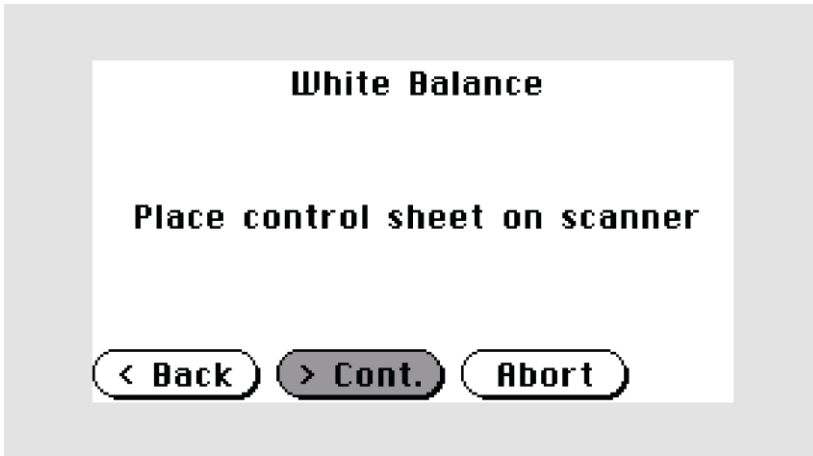

The white balance starts and the calibration is performed. During the white balance, a rotating icon appears. The test target is transported forward and returned. The entire white balance sequence takes about 50 seconds.

Then, the white balance result is displayed as shown on the example below.

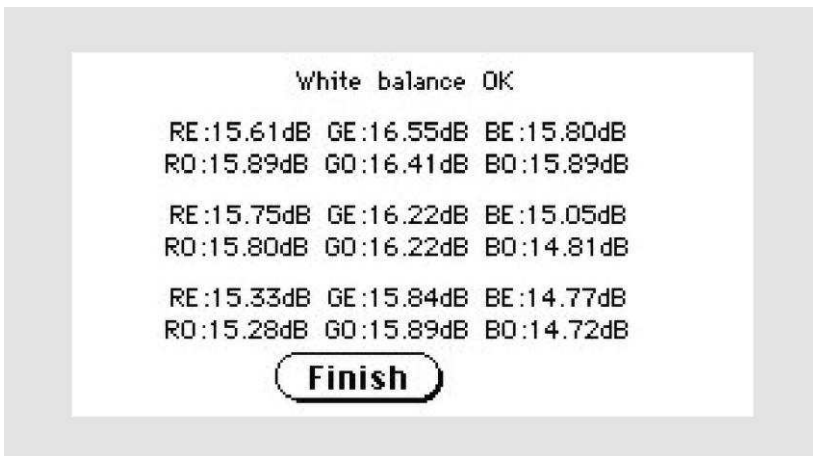

➤ Tap on FINISH to switch back to "Self Test 1" menu.

- i On an error-free white balance calibration, the result is displayed with the message White balance OK.
 An incorrect result is displayed with the message White balance Error.
 If this is the case, the white balance calibration must repeated again.

After a successful white balance, proceed as follows:

- Remove the test target.
- Store the test target in a place which is protected from daylight.
- Ensure that the test target is not damaged, bent or soiled.

Lamp On/Off

- i This function is not relevant for setting up the device.
- On "Self Test 1" screen, press the LAMP ON / OFF button (4) to turn on the LED lights.

The lamps switch off as soon as the button is no longer pressed.

Touch Adjust

ATTENTION!	
	<p>The Touch Adjust function should only be carried out by a technician certified by ImageAccess, as this may impair the functionality of the device. This function is not relevant for setting up the device.</p> <ul style="list-style-type: none"> ➤ Contact Image Access technical support, see section <i>Technical Support</i> starting at page 6.

Touch Test

i This function is not relevant for setting up the device.

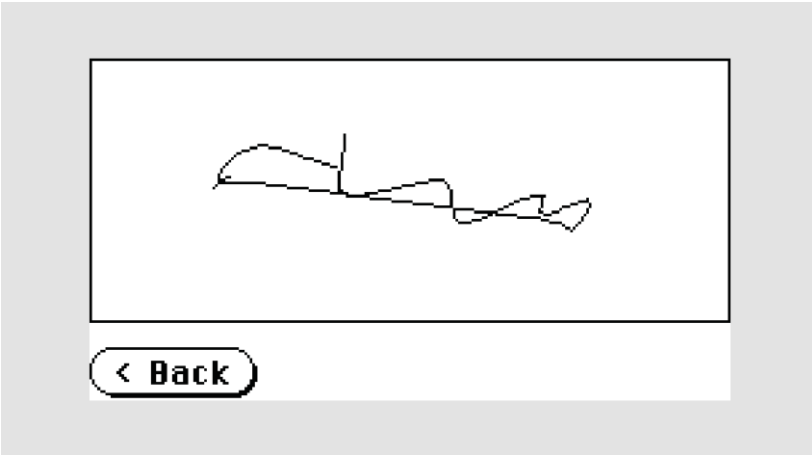

- On the "Self Test 2" screen, tap on Touch Test (2).
After selecting this function, the touchscreen displays an empty area.
Use a suitable stylus to draw some arbitrary characters on the touchscreen.
- Check the match between the write position and the displayed position.
If the deviation is too great, repeat the adjustment described in chapter Touch Adjust.
- To return to the Self Test 2 screen, tap the Back button.

Stitch Test

- ⓘ This function is only intended for technicians certified by Image Access and not relevant for setting up the device.

EMV Test

- ⓘ This function is only intended for technicians certified by Image Access and not relevant for setting up the device.

Sensor Test

- ⓘ This function is not relevant for setting up the device.
- On the "Self Test 2" screen, tap SENSOR TEST (5).
- Feed a sheet of paper that covers the entire document width of the scanner into the document transport.

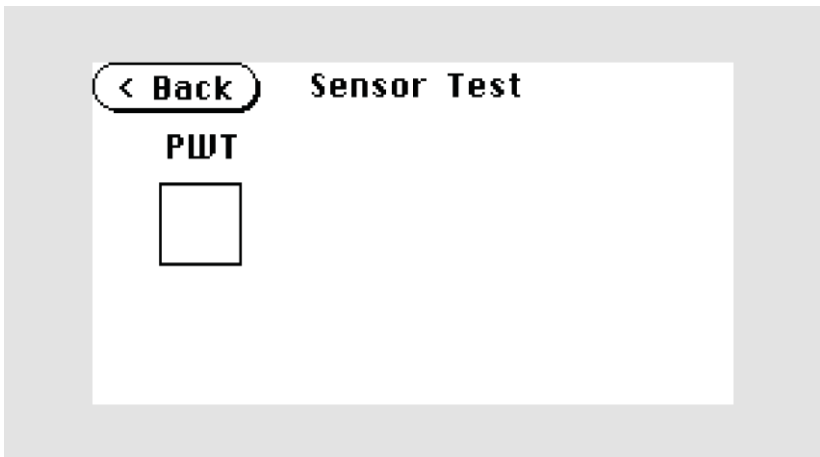

No paper detected by the sensor.

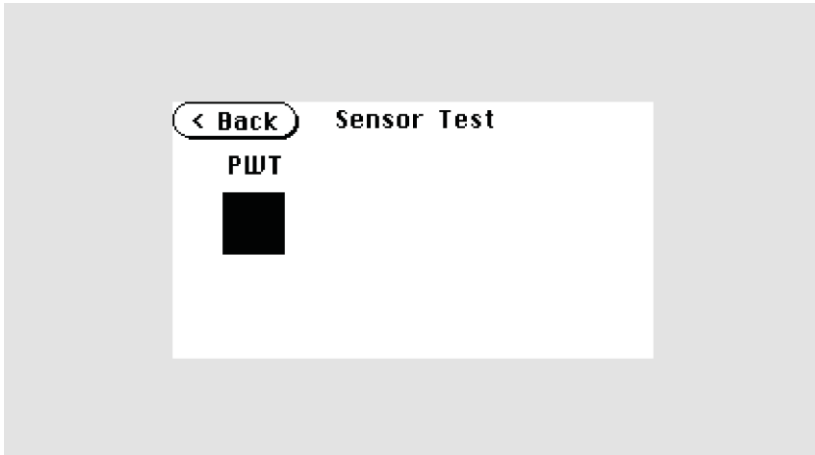

Paper detected by the sensor.

Shutdown Scanner

- On the "Self Test 2" screen press the SHUTDOWN SCANNER button to switch the scanner to standby mode.

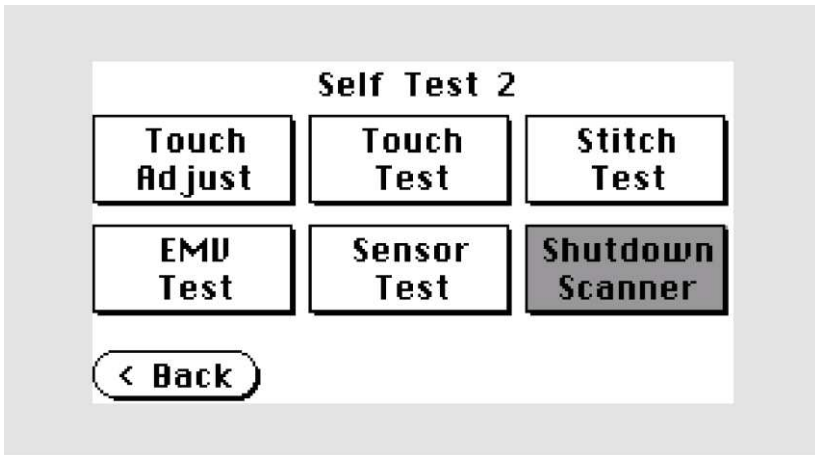

Technical Specifications

WideTEK® 36DS Scanner Specification

Optical System WideTEK® 36DS

Maximum document size	970 mm / 38,2 inch
Scan width	915 mm / 36 inch
Scanner resolution	1200 × 1200 dpi (optional 9600 × 9600 dpi interpolated)
Optical resolution	1200 × 600 dpi
Pixel size	9,3 × 9,3 μm
Sensor type	3 x Tri-color CCDs, encapsulated and dust-proof
Color depth	16 bit grayscale (internal resolution) 48 bit color (internal resolution)
Sensor resolution	67.500 pixels (3 x 22.500)
Scan modes	24 bit color, 8 bit color indexed, 8 bit grayscale, bitonal, halftone
File formats	Multipage PDF (PDF/A) and TIFF, JPEG, JPEG 2000, PNM, PNG, BMP, TIFF (Raw, G3, G4, LZW, JPEG), AutoCAD DWF, JBIG, DjVu, DICOM, PCX, Postscript, EPS, Raw data

Illumination WideTEK® 36DS

Light source	Two lamps with white LEDs, integrated optical diffuser
Warm up time of the lamps	None. Maximum brightness after switching on.
Temperature induced change	None
UV / IR radiation	None
Lifetime of the LEDs	50,000 hours (typically)

Optical System WideTEK® 36DS

Maximum document size	970 mm / 38,2 inch
Scan width	915 mm / 36 inch
Scanner resolution	1200 × 1200 dpi (optional 9600 × 9600 dpi interpolated)
Optical resolution	1200 × 600 dpi
Pixel size	9,3 × 9,3 μm
Sensor type	3 x Tri-color CCDs, encapsulated and dust-proof
Color depth	16 bit grayscale (internal resolution) 48 bit color (internal resolution)
Sensor resolution	67.500 pixels (3 x 22.500)
Scan modes	24 bit color, 8 bit color indexed, 8 bit grayscale, bitonal, halftone
File formats	Multipage PDF (PDF/A) and TIFF, JPEG, JPEG 2000, PNM, PNG, BMP, TIFF (Raw, G3, G4, LZW, JPEG), AutoCAD DWF, JBIG, DjVu, DICOM, PCX, Postscript, EPS, Raw data

Ambient Conditions

Ambient temperature during operation	+5 to +40 °C
Storage temperature	0 to +60 °C
Relative humidity	20 to 80% (non-condensing)
Noise development	≤ 35 dB(A) (Scanning) ≤ 25 dB(A) (Standby)

Electrical Data

External Power Supplies

Input voltage	100–240 Vac
Frequency	47–63 Hz
Output voltage	24 Vdc
Output current	6,25 A
ECO Standard	CEC Level VI

Scanner

Input voltage	2 * 24 Vdc
Input current (fused)	2 * max. 5 A

Power consumption WideTEK® 36DS

Sleep mode	≤ 0,5 W
Standby mode	ca. 10,4 W
Ready to scan	< 100 W
Scanning	< 190 W

Document specifications

Document length	up to 500 m / 20.000 inch ¹
Paper weight	any
Document thickness	2,5 mm / 0,1 inch max.

¹The maximum document length depends on the scan resolution and the scan mode.

Dimensions and Weight WideTEK® 36DS

Scanner (H × W x D)	248 x 1094 x 685 mm
Scanner with floor stand (H × W x D)	1070 x 1094 x 685 mm
Scanner weight	64 kg
Floor stand weight / including the paper catch	18,5/20,7 kg
Transport box (H × W x D)	470 x 1200 x 800 mm
Weight, ready to ship	80 kg
Transport box - BDL ² (H × W x D)	670 x 1200 x 800 mm
Weight, ready to ship - BDL	125 kg

²Bundled scanner system

End of document

