



WideTEK® 36/44/48



## Setup Instructions English

01/2017

# Contents

<b>Information about the Instructions and the Manufacturer .....</b>	<b>4</b>
Keep Instructions with the Scanner .....	4
Design Features in Text.....	5
Design Features in Pictures.....	5
Associated Documents .....	6
Copyright .....	6
Contact Data of the Manufacturer in Germany.....	6
Technical Support .....	6
Contact Data of the Manufacturer in the U.S.....	6
<b>Safety.....</b>	<b>7</b>
Intended Use .....	7
Basic Safety Information.....	7
Avoiding Property Damage and Malfunctions.....	8
Responsibility of the Owner .....	9
Staff Qualifications.....	9
Design Features of Warning Notices .....	10
Formatting of Information Regarding Property Damage.....	10
<b>Description .....</b>	<b>11</b>
Purpose and Function .....	11
WideTEK 36 Overview.....	11
WideTEK 44 Overview.....	12
WideTEK 48 Overview.....	13
Rear View .....	14
Setup Menu Overview Screen .....	15
Rating Plate.....	16
<b>Prepare for Setup.....</b>	<b>19</b>
Connect the Power Supply .....	19
Establish the Network Connection .....	19
Positioning the Scanner on the Optional Floor Stand.....	20

Connect the Optional Foot Switch .....	20
Connect the Optional Monitor .....	21
Connect the Optional Touchscreen .....	22
Switch On the Scanner .....	23
Switch Off the Scanner .....	25
<b>Perform Setup.....</b>	<b>27</b>
Change the Menu Language .....	27
Activate the Setup Menu.....	29
Perform White Balance .....	33
Assign the IP Address .....	42
Modify User Settings .....	51
Set the Time and Date .....	59
Perform Test Suite .....	64
Touchscreen Test.....	69
<b>Technical Specifications .....</b>	<b>71</b>
WideTEK® 36/44/48 Scanner Specification .....	71
Ambient Conditions.....	74
Electrical Data.....	74
Document specifications .....	75
Dimensions and Weight WideTEK® 36 .....	75
Dimensions and Weight WideTEK® 44/48.....	76

## **Information about the Instructions and the Manufacturer**

These instructions show you how to safely prepare and perform the setup for the wide format scanners WideTEK® 36/44/48. The WideTEK® 36/44/48 scanners are hereinafter referred to as "Scanner".

In these instructions, the start button is called "power button".

### **Keep Instructions with the Scanner**

These instructions are a part of the scanner.

- Please always store these instructions together with the scanner.
- Ensure that the instructions are available for the user.
- Enclose the instructions when you sell the scanner or transfer it in any other way.

## Design Features in Text

Many text passages in these instructions have been formatted to indicate specific elements, as illustrated below:

Normal text

**BUTTONS OF THE SCREEN PAGE**

"Menu names"

➤ Action steps

• Enumeration of the first level

*Cross-references*

 Tips contain additional information, such as special information to prepare for and perform the setup.

## Design Features in Pictures

Where a reference is made to elements in a legend or in the text, these are marked with a number (1).

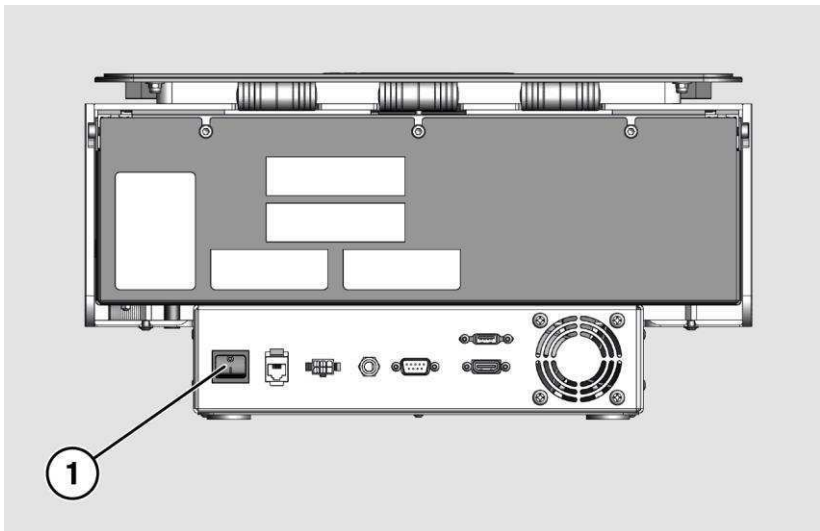

## Associated Documents

In addition to these instructions, other documents associated with the operation of the scanner include:

- Unpacking and Repacking Instructions
- Legal Information (Declarations of Conformity, FCC Declaration, Safety & EMI Certificates, RoHS etc.).

## Copyright

These instructions contains information that is subject to copyright. These instructions may not be reproduced in any form, printed, filmed, edited, copied or distributed, in whole or in part, without prior written permission from Image Access GmbH.

© Image Access GmbH 2017

All rights reserved.

## Contact Data of the Manufacturer in Germany

Image Access GmbH  
Hatzfelderstraße 161-163  
42281 Wuppertal  
Phone: +49-202-27058-0  
E-Mail: [documentation@imageaccess.de](mailto:documentation@imageaccess.de)  
Internet address: [www.imageaccess.de](http://www.imageaccess.de)

## Technical Support

Image Access technical support can be reached at the e-mail address: [support@imageaccess.de](mailto:support@imageaccess.de).

## Contact Data of the Manufacturer in the U.S.

Image Access LP  
745 Duffy Drive, Unit D  
Crystal Lake  
IL 60014  
Phone: +1-779-220-4662  
E-Mail: [support@imageaccess.us](mailto:support@imageaccess.us)  
Internet address: [www.imageaccess.us](http://www.imageaccess.us)

## Safety

### Intended Use

The scanner is used for scanning images and documents. The documents must comply with the characteristics described in the technical specifications. The scanner is designed for use in enclosed spaces in the commercial sector.

Intended use also includes observing and following all information provided in these instructions, especially the safety instructions. Any other use is considered to be improper and will void the warranty and liability claims.

### Ambient Conditions

Ensure that the scanner is used exclusively under the following environmental conditions:

- Ambient temperature during operation: +5 °C to +40 °C
  - Storage temperature: 0 °C to +60 °C
  - Relative humidity: 20 to 80%, non-condensing
- Ensure that the scanner is not exposed to direct sunlight.

## Basic Safety Information

### Avoid Injury or Death by Electric Shock

- Never open the housing of the scanner.
- Do not expose the scanner to dripping or splashing water and do not place any vessel filled with liquid on the scanner. Penetrating liquid can damage the scanner.
- Do not insert objects through existing slots or openings into the interior of the scanner.

- Only connect the scanner with the plug of the supplied AC adapter to a professionally installed and grounded outlet.
- Do not use the AC adapter if the power supply's housing or the cable are damaged. In this case, replace the power supply with a power supply of the same type.
- Do not use the scanner if it is visibly damaged. In this case, unplug the power cord from the wall outlet. Contact Image Access technical support, see section *Technical Support* starting at page 6.

### **Avoid Burns**

- Do not cover the existing openings in the scanner housing. They serve to ventilate. Covering the openings could cause overheating.
- Do not place the scanner in front of air conditioning units, which produce high heat.

### **Avoid Fractures, Contusions and Bruises**

Incorrect installation of the cables can cause tripping.

- Lay the connecting cables so that no one can trip over them.

The scanner weighs between 41 and 53 kg, depending on the model.

- Only carry the scanner with a second person.
- Place the scanner only on a stable, level and vibration-free surface that has sufficient strength for the weight of the scanner.

### **Avoiding Property Damage and Malfunctions**

- Ensure adequate ventilation to comply with the environmental conditions.
- Do not place the scanner in the vicinity of devices that emit strong electromagnetic radiation.
- Always place the scanner on a suitable, stable table or the optional floor stand.
- Do not lean on the scanner.
- Ensure that the thickness of the material to be scanned does not exceed 2,5 mm.
- Do not use any cleaning agents containing abrasive additives, solvents or acids. Use a damp microfiber cloth.
- Operate the touchscreen only with your finger. Other objects can damage the touchscreen.



## **Responsibility of the Owner**





The scanner owner must ensure that only qualified personnel carry out the setup of the scanner.

## **Staff Qualifications**



The staff that carries out the setup of the scanner must have knowledge in installing, connecting and putting computer accessories into operation.

## Design Features of Warning Notices

In these instructions, the following warning information can be found:

 <b>WARNING</b>	
	Notices with the word <b>WARNING</b> warn about a dangerous situation that could lead to death or serious injuries.
 <b>CAUTION</b>	
	Notices with the word <b>CAUTION</b> warn about a situation that could lead to light or medium-scale injuries.

The following symbols are used in the warnings:

Symbol	Explanation
	Danger from electrical shock
	General danger symbol

## Formatting of Information Regarding Property Damage

<b><i>ATTENTION!</i></b>	
	These notices warn of situations that can lead to property damage.

## Description

### Purpose and Function

The scanner is used for scanning images and documents. It is designed for use in enclosed spaces in the commercial sector. Intended use also includes observing and following all instructions in these instructions, especially the safety instructions. Any other use is considered to be improper and will void the warranty and liability claims.

### WideTEK 36 Overview

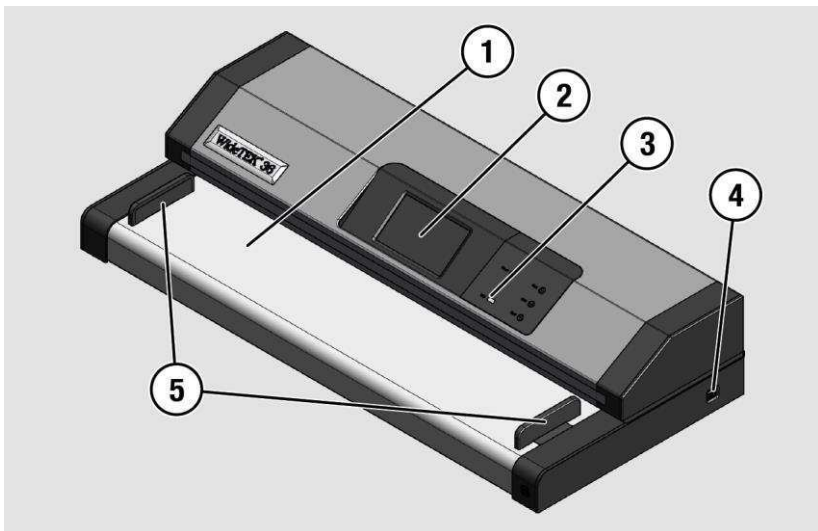

No.	Name
1	Document transport
2	Touchscreen
3	Power button
4	Main switch
5	Transport guides

## WideTEK 44 Overview

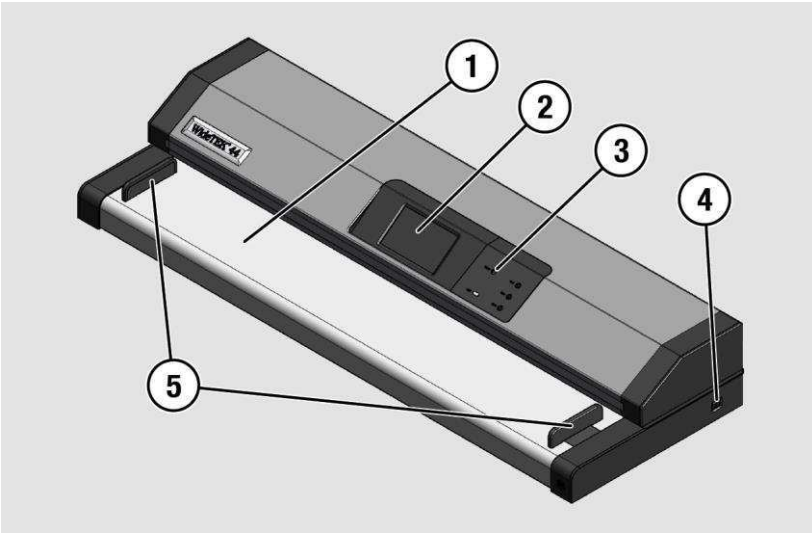

No.	Name
1	Document transport
2	Touchscreen
3	Power button
4	Main switch
5	Transport guides

 The WideTEK 44 scanner can be extended to a WideTEK 48 by purchasing a software option.

## WideTEK 48 Overview

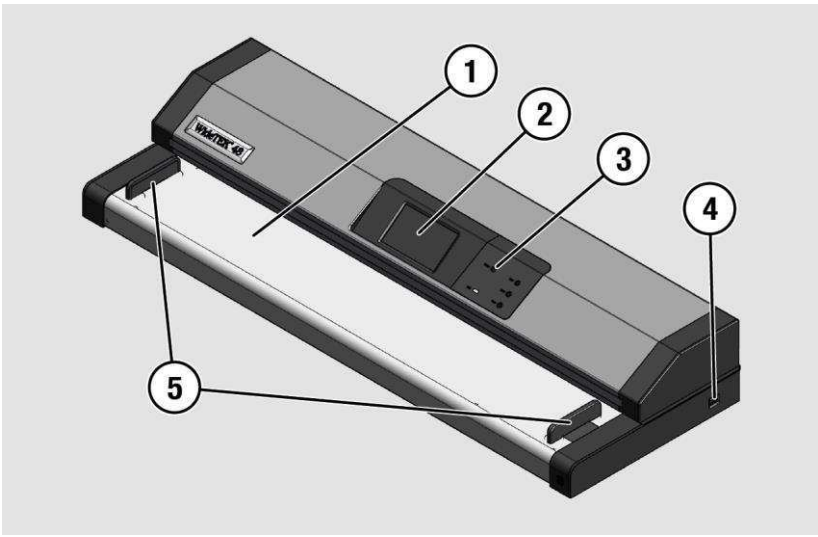

No.	Name
1	Document transport
2	Touchscreen
3	Power button
4	Main switch
5	Transport guides

## Rear View

The following diagram shows the rear view of the WideTEK® 36 model.

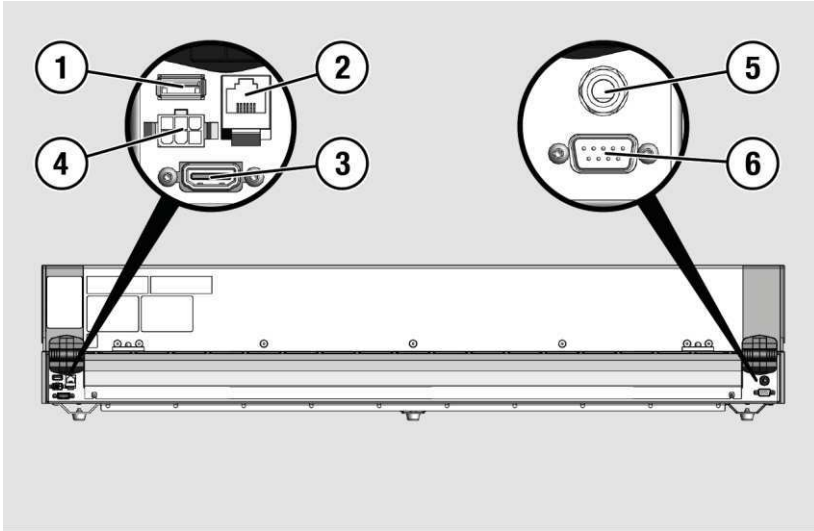

No.	Name
1	USB connector
2	Network connector
3	HDMI connector
4	24 V DC connector for external power supply
5	Foot switch connector
6	Recovery key connector

## Setup Menu Overview Screen

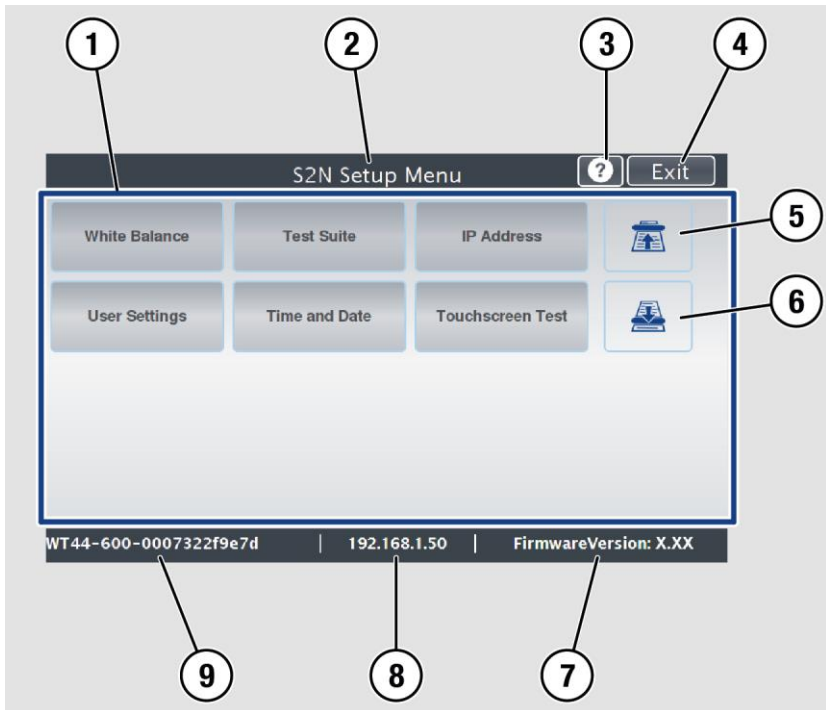

No.	Name
1	Buttons and parameters
2	Menu name
3	Display the online help <sup>1</sup>
4	Button to leave the setup menu to the start screen
5	Button to drive the document forward in the scanner
6	Button to drive the document backward in the scanner (rewind).
7	Firmware version
8	IP address
9	Serial number

<sup>1</sup> The display of the online help is only available when a second touchscreen is connected to the scanner.

## Rating Plate

The rating plate is attached to the back of the scanner.

The following figure shows the WideTEK® 36 rating plate.

Type/品类: **Wide F. Scanner**/大幅面扫描仪  
 Model/型号: **WT36-600**  
 Volt/电压: **24DC** Amperes/电流: **5**



 Conforms to  
 UL Std. **60950-1**  
 Cert. to CAN/CSA Std.  
 C22.2 No. **60950-1**

Self Declaration: Conforms to IS 13252 (Part 1):2010, R-41006580

 This device complies with part 15 of the FCC Rules.  
 Operation is subject to the following two conditions:  
 (1) This device may not cause harmful interference  
 (2) this device must accept any interference received,  
 including interference that may cause undesired operation.







**Made in Germany** 德国制造  
 Image Access GmbH, Wuppertal  
[www.imageaccess.de](http://www.imageaccess.de)

Serial #./Manufacturing Date on Barcode Label



The following figure shows the WideTEK® 44 rating plate.

Type/品类: **Wide F. Scanner/大幅面扫描仪**  
 Model/型号: WT44-600  
 Volt/电压: 24DC Amperes/电流: 5



 Conforms to  
 UL Std. 60950-1  
 Cert. to CAN/CSA Std.  
 C22.2 No.60950-1  

  
 Intertek Intertek  
 3171507

Self Declaration: Conforms to IS 13252 (Part 1):2010, R-41006580

 This device complies with part 15 of the FCC Rules.  
 Operation is subject to the following two conditions:  
 (1) This device may not cause harmful interference  
 (2) this device must accept any interference received,  
 including interference that may cause undesired operation.







**Made in Germany 德国制造**  
 Image Access GmbH, Wuppertal  
[www.imageaccess.de](http://www.imageaccess.de)

Serial #./Manufacturing Date on Barcode Label

## Description

The following figure shows the WideTEK® 48 rating plate.

Type/品类: **Wide F. Scanner**/大幅面扫描仪  
 Model/型号: WT48-600  
 Volt/电压: 24DC      Amperes/电流: 5

  
  
 Intertek

Conforms to  
 UL Std. **60950-1**  
 Cert. to CAN/CSA Std.  
 C22.2 No. **60950-1**

  
 Intertek  
 3171507

Self Declaration: Conforms to IS 13252 (Part 1):2010, R-41006580



This device complies with part 15 of the FCC Rules.  
 Operation is subject to the following two conditions:  
 (1) This device may not cause harmful interference  
 (2) this device must accept any interference received,  
 including interference that may cause undesired operation.















**Made in Germany** 德国制造  
 Image Access GmbH, Wuppertal  
[www.imageaccess.de](http://www.imageaccess.de)

Serial #./Manufacturing Date on Barcode Label

## Prepare for Setup



### Connect the Power Supply

 <b>WARNING</b>	
	<p>Risk of electric shock due to incorrect connection.</p> <ul style="list-style-type: none"> <li>➤ Ensure that the power receptacle intended for the connection is properly grounded.</li> <li>➤ Ensure that the power receptacle intended for the connection of the scanner is properly fused.</li> </ul>
 <b>CAUTION</b>	
	<p>Incorrect laying of the connection cables can cause tripping. Fractures, contusions and bruises can be the result.</p> <ul style="list-style-type: none"> <li>➤ Place the connecting cables so that nobody can trip over them.</li> </ul>

To connect the power supply, proceed as follows:

- Make sure that the main switch of the scanner is switched off (0 position).
- Use only the AC adapter and power cord supplied.
- Ensure the power cord is not damaged.
- Connect the connector from the power supply to the associated 24 V DC connector on the back of the scanner.
- If not already done, connect the supplied power cable to the associated connector on the power supply.
- Connect the power plug of the power supply to a power receptacle of the correct voltage (100-240 VAC).



### Establish the Network Connection

 <b>CAUTION</b>	
	<p>Incorrect laying of the connection cables can cause tripping. Fractures, contusions and bruises can be the result.</p> <ul style="list-style-type: none"> <li>➤ Place the connecting cables so that nobody can trip over them.</li> </ul>

To establish the network connection, proceed as follows:

- Connect one plug of the enclosed network cable to the network connector socket on the back of the scanner.
- Connect the second plug to the network socket of an existing network.



## Positioning the Scanner on the Optional Floor Stand

 <b>CAUTION</b>	
	<p>The scanner weighs between 41 kg and 53 kg, depending on the model.</p> <ul style="list-style-type: none"><li>➤ Only carry the scanner with a second person.</li><li>➤ Ensure that the scanner is secured so that it does not fall over.</li></ul>

To position the scanner on the optional floor stand, proceed as follows:

- Assemble the floor stand according to the floor stand assembly instructions.
- Position the scanner on the floor stand as described in the accompanying floor stand assembly instructions.

## Connect the Optional Foot Switch

 <b>CAUTION</b>	
	<p>Incorrect laying of the connection cables can cause tripping. Fractures, contusions and bruises can be the result.</p> <ul style="list-style-type: none"><li>➤ Place the connecting cables so that nobody can trip over them.</li></ul>

To connect the optional foot switch, proceed as follows:

- Connect the plug of the foot switch to the connector socket for the foot switch, located on the back of the scanner.

## Connect the Optional Monitor

### CAUTION



Incorrect laying of the connection cables can cause tripping. Fractures, contusions and bruises can be the result.

- Place the connecting cables so that nobody can trip over them.

To connect the optional monitor, proceed as follows:

- Connect the HDMI connector plug of the monitor to the HDMI connector socket, located on the back of the scanner.

## Connect the Optional Touchscreen

### CAUTION



Incorrect laying of the connection cables can cause tripping. Fractures, contusions and bruises can be the result.

- Place the connecting cables so that nobody can trip over them.

To connect the optional touchscreen, proceed as follows:

- Connect the HDMI connector plug of the touchscreen to the HDMI connector socket, located on the back of the scanner.
- Connect the USB connector plug of the touchscreen to the USB connector socket, located on the back of the scanner.

## Switch On the Scanner

To switch on the scanner, proceed as follows:

- Press the MAIN SWITCH (1) to the "I" position.

The following diagram shows the scanner model WideTEK® 36.



The scanner is in standby mode. The power switch is illuminated in red.

## Prepare for Setup

To start the scanner from standby mode, proceed as follows:

- Press the red illuminated power button.

The power button lights up in blue.

The scanner performs a system test. After a short wait, the "Start screen" is displayed in English.





## Switch Off the Scanner

To switch the scanner to standby mode after performing the setup, proceed as follows:

- On the "Start screen" screen tap on SHUTDOWN (1).



- Confirm with YES.

The scanner shuts down. This process can take up to 40 seconds.

The power button lights up red. The scanner is in standby mode.

## Prepare for Setup

Alternatively, switch the scanner into the standby mode as follows:

- Press the blue illuminated power button and hold it for six seconds.

The scanner shuts down. This process can take up to 40 seconds.

The power button lights up red. The scanner is in standby mode.

To switch off the scanner for longer periods, proceed as follows:

- Make sure that the scanner is in standby mode.

The power button is illuminated in red.

- Press the MAIN SWITCH (1) in the "0" position.

The following diagram shows the scanner model WideTEK® 36.



## Perform Setup

### Change the Menu Language

To change the menu language, proceed as follows:

- Tap the LANGUAGE (1) button.

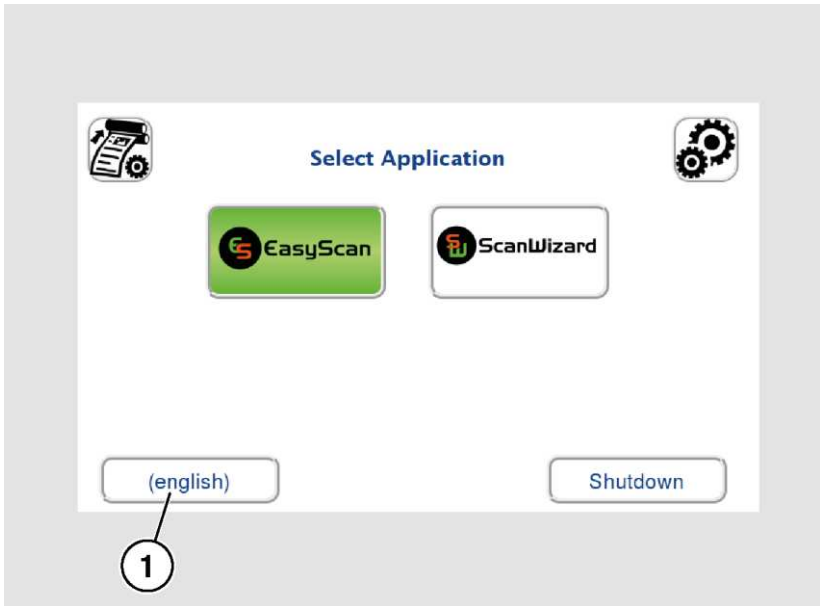

A window for selecting the language appears.

- To display more languages, slide the scroll bar (1) downward.



- Tap the desired language.

The window for selecting the language is closed. The "Start screen" is displayed.

## Activate the Setup Menu

To activate the setup menu, you have to log in on the scanner. Proceed as follows:

- Tap the GEAR SYMBOL (1).

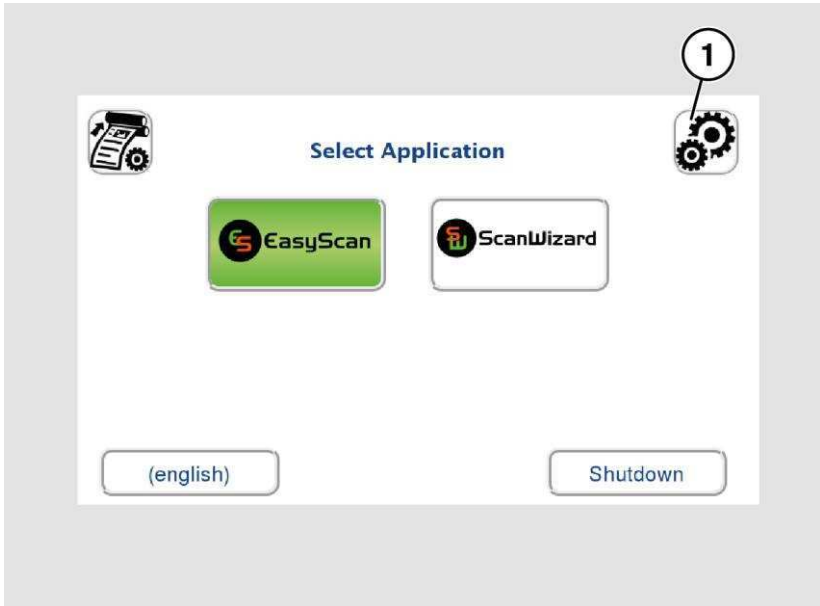

The login window appears.

- In the login window, enter the login credentials.
- To enter the credentials, tap with your finger on the corresponding input field.

The screen keyboard is displayed.

- Enter the word "Poweruser" in the fields "Username" (1) and "Password" (2).
- Please note that the input is case sensitive.

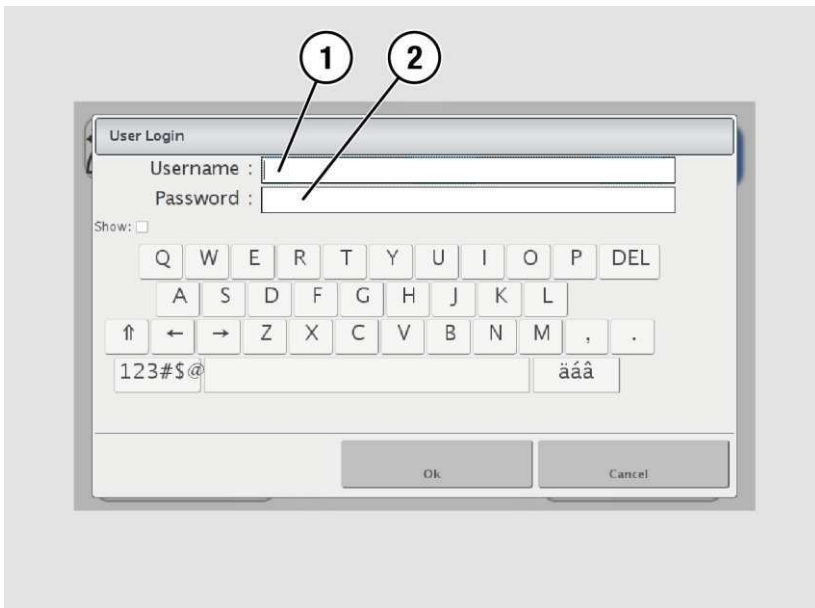

- To complete the log in, press OK (1).

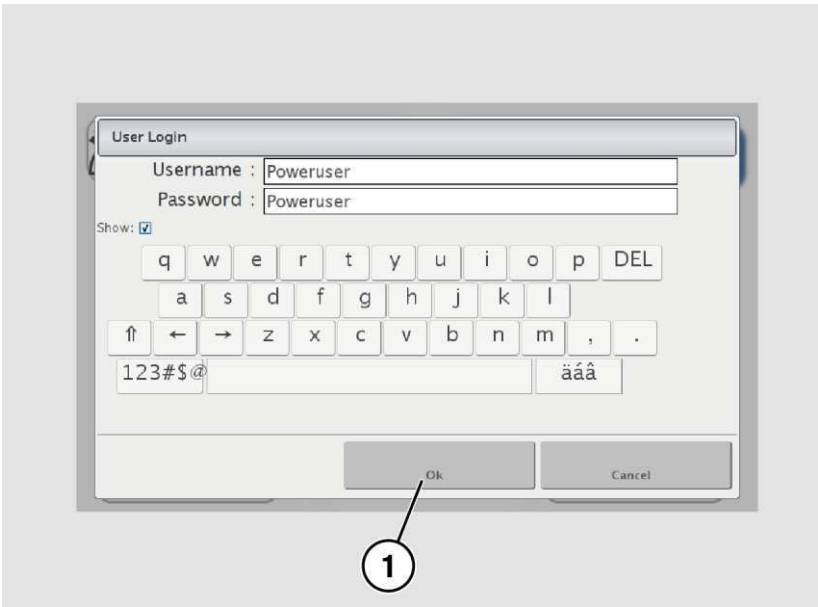

The "Setup Menu" screen is displayed.



- White Balance: Display the "White Balance" submenu
- Test Suite: Display the "Test Suite" submenu
- IP Address: Display the "IP Address" submenu
- User Settings: Display the "User Settings" submenu
- Time and Date: Display the "Time and Date" submenu
- Touchscreen Test: Display the "Touchscreen Test" submenu

➤ To select a submenu from the "Setup menu" screen, tap with your finger on the button of the screen.



## Perform White Balance

- On the "Setup Menu" screen, tap on WHITE BALANCE (1).

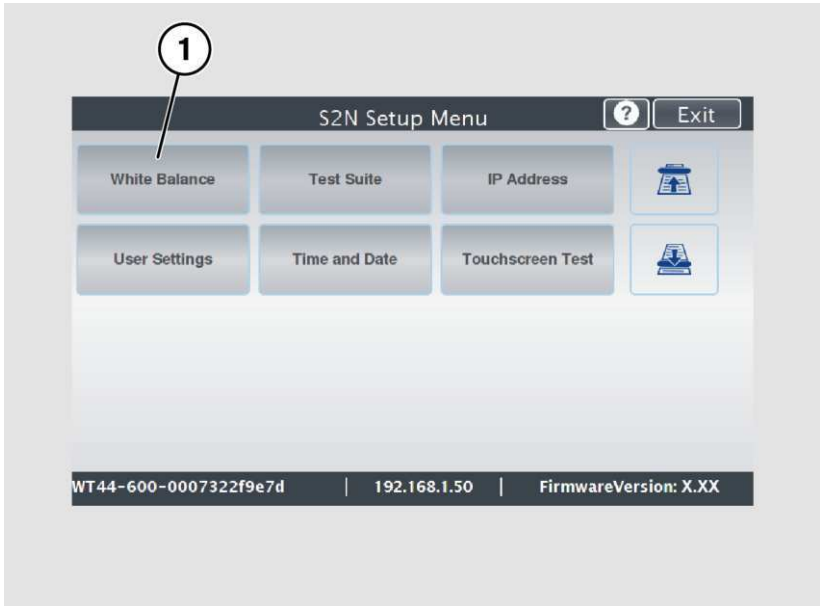

The "White Balance" screen is displayed.



- Calibrate: Start white balance
- Delete White Balance Data: Delete existing white balance data

The white balance is used to ensure the quality of the scan results. The white balance will be carried out using a test target. The test targets are marked as follows:

- WT36C-Z-01-A for WideTEK® 36
- WT48-WA-01-A for WideTEK® 44
- WT48-WA-01-A for WideTEK® 48.

Before beginning the white balance procedure, remove the transport guides. To remove the transport guides, proceed as follows:

- Lift the transport guides (1) approximately 5 mm (1.).
- Pull the transport guides (1) inwards (2.).

The following diagram shows the scanner model WideTEK® 36.

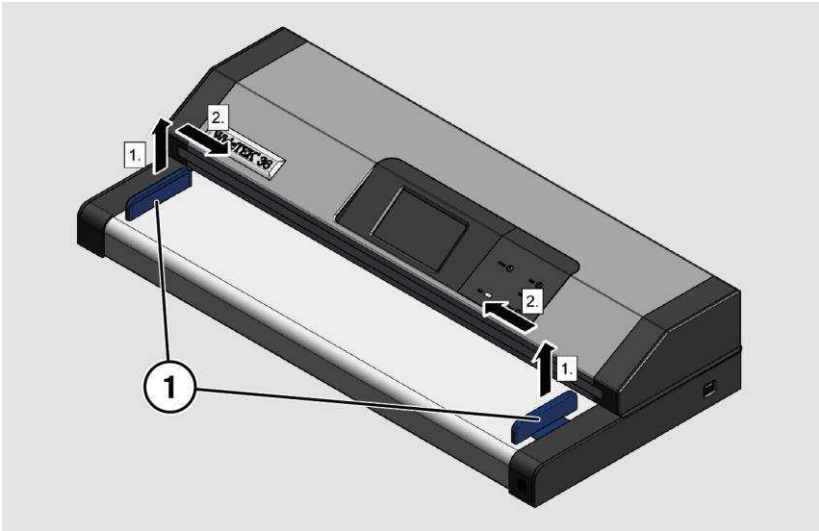

**ATTENTION!**

Impairment of the scan quality can occur if an improper test target for the white balance is used.

- Make sure that the test target is free from wrinkles, discolorations, cracks or other damage.
- Store the test target for the white balance in a safe place protected from daylight.

To perform the white balance, proceed as follows:

- Position the supplied test target (1) in the document transport as illustrated below (2).

The test target (1) is pulled into the scanner.

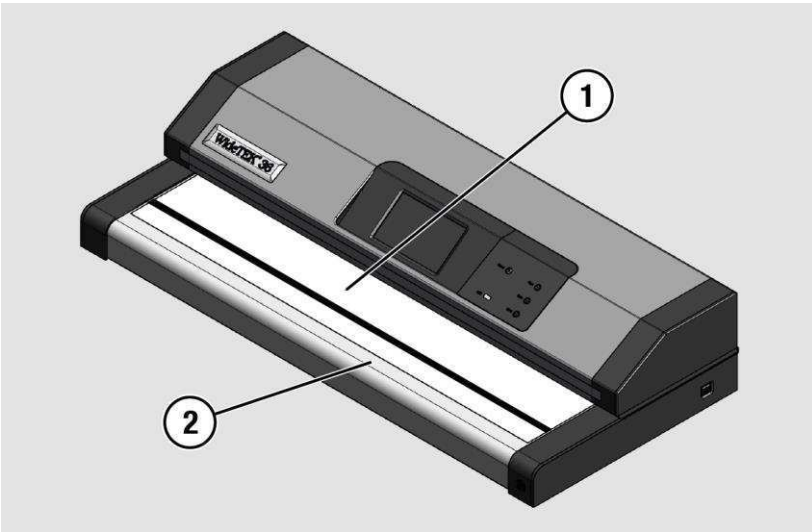

- Tap on CALIBRATE (1).

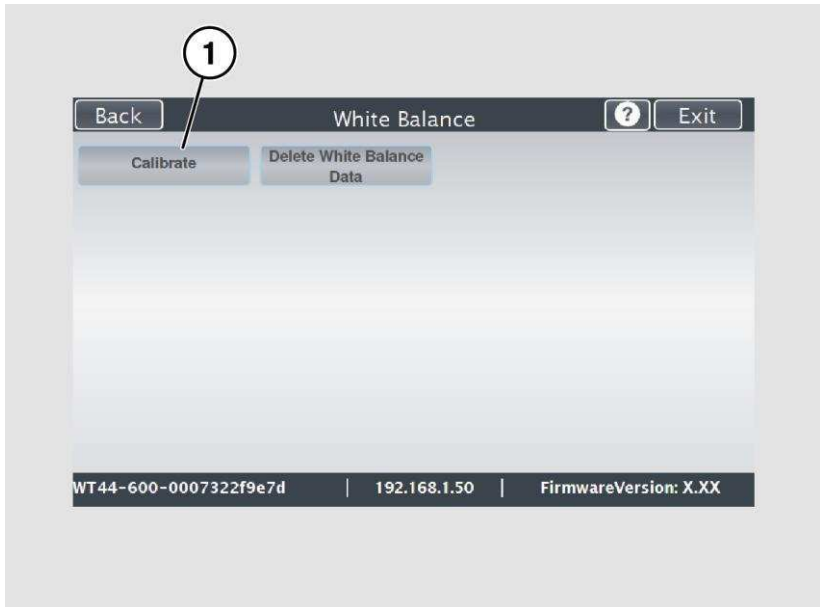

➤ Tap on NEXT STEP (1).



The white balance starts and the calibration is performed. During the white balance, a rotating icon appears. The test target is transported forward and returned. The entire white balance sequence takes about 50 seconds.

Then, the white balance result is displayed as shown on the example below.



- ① On an error-free white balance calibration, the result is displayed in green.  
An incorrect result is displayed in red. If this is the case, the white balance starts over again.

## Perform Setup

- To perform the white balance again, tap NEW VALUES (2).
- To return to the previous submenu, tap BACK (1).
- To return to the "Start screen", tap EXIT (3).

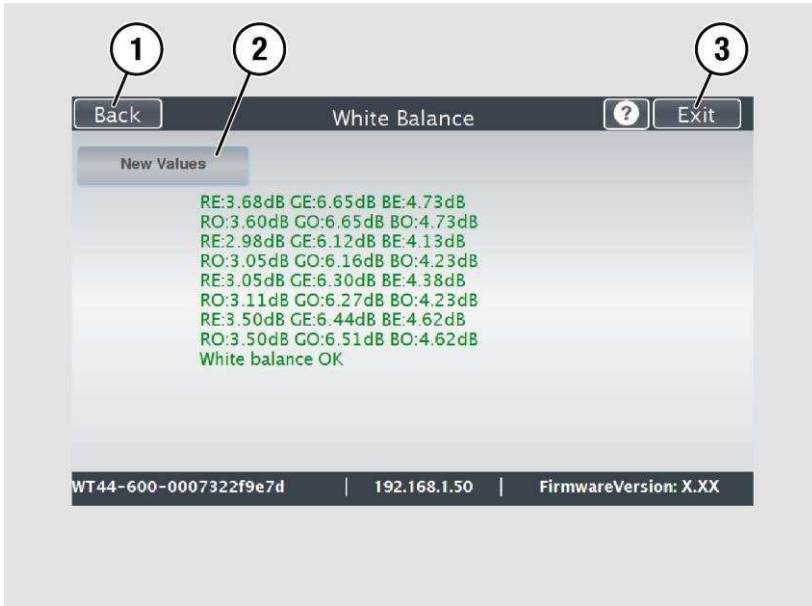



- To delete the stored data of the white balance calibration, tap DELETE WHITE BALANCE DATA (2).
- After deleting the stored data, run the white balance again, as described.
- If problems arise during the white balance calibration, contact Image Access technical support, see section *Technical Support* starting at page 6.
- To return to the previous submenu, tap BACK (1).
- To return to the "Start screen", tap EXIT (3).

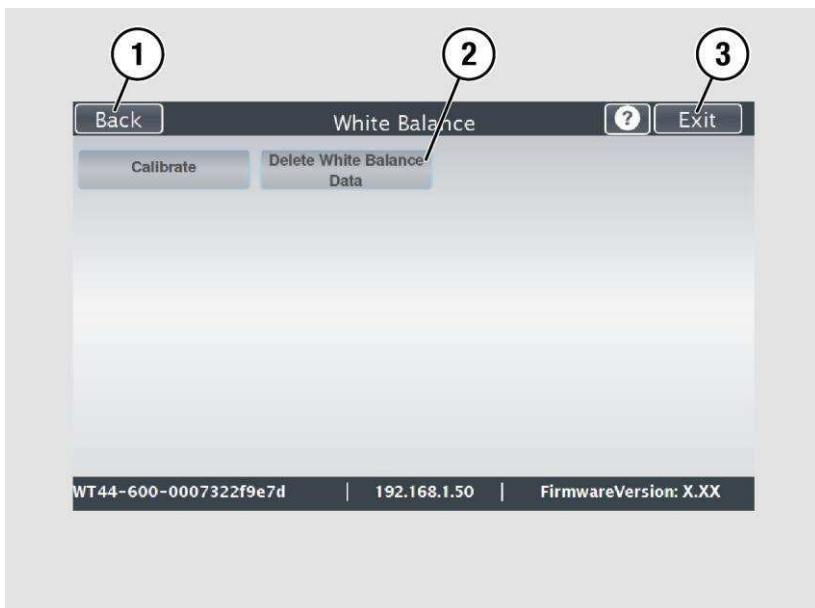

After a successful white balance, proceed as follows:

- Remove the test target.
- Put the transport guides back into their position.
- Store the test target in a place which is protected from daylight.
- Ensure that the test target is not damaged, bent or soiled.

## Assign the IP Address

### Manually Assign the IP Address

To manually assign the IP address, proceed as follows:

- On the "Setup Menu" screen, tap on IP Address (1).

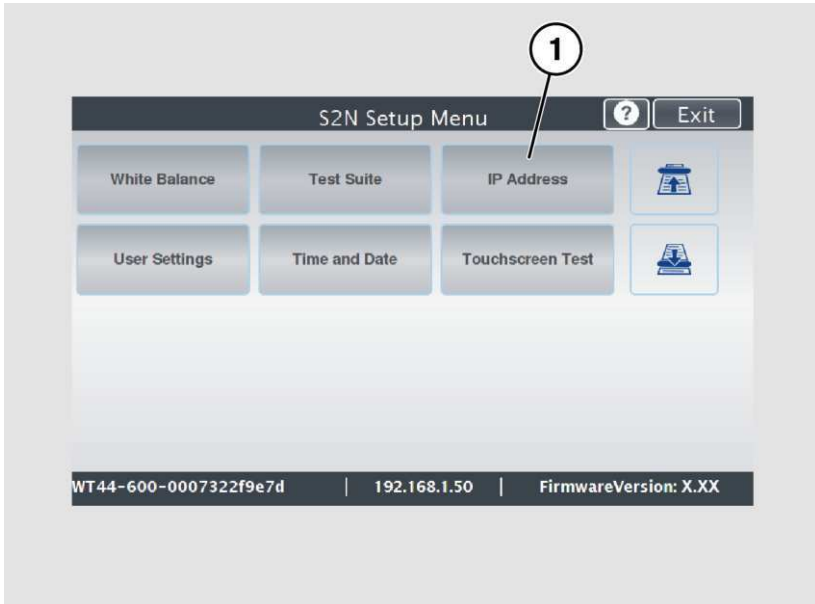

The "IP Address" screen is displayed.



Set network settings:	Accept the network settings provided
Reset to Factory:	Reset to factory settings
IP Address:	Input field for the IP address
Subnet Mask:	Input field for data on the subnet mask
Gateway:	Input field for the gateway address
IP Configuration Method	Assign an IP address manually or automatically
Manual/DHCP:	
Wireless LAN	Without or with a WLAN connection
No/Yes	

➤ Tap the "IP Address" (1) field.

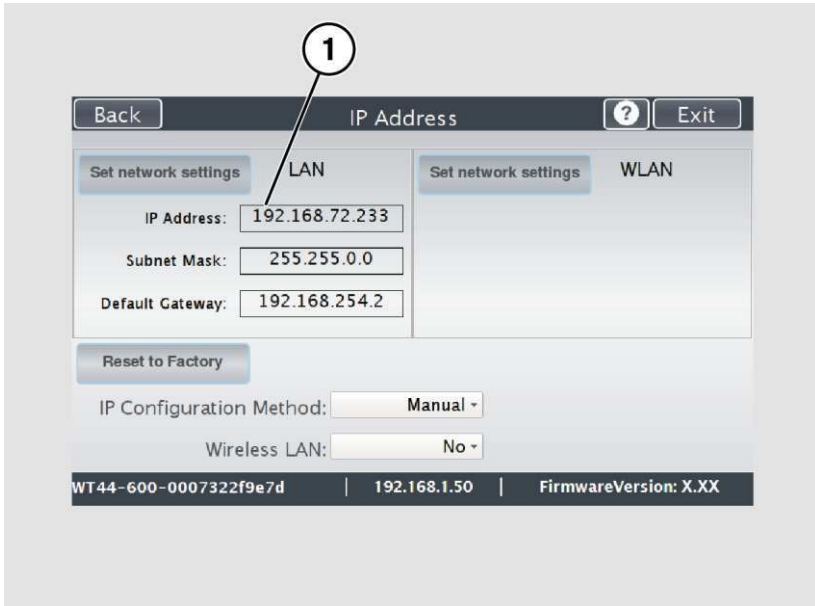

The "IP Address" window is displayed.

- Enter the IP address (1).

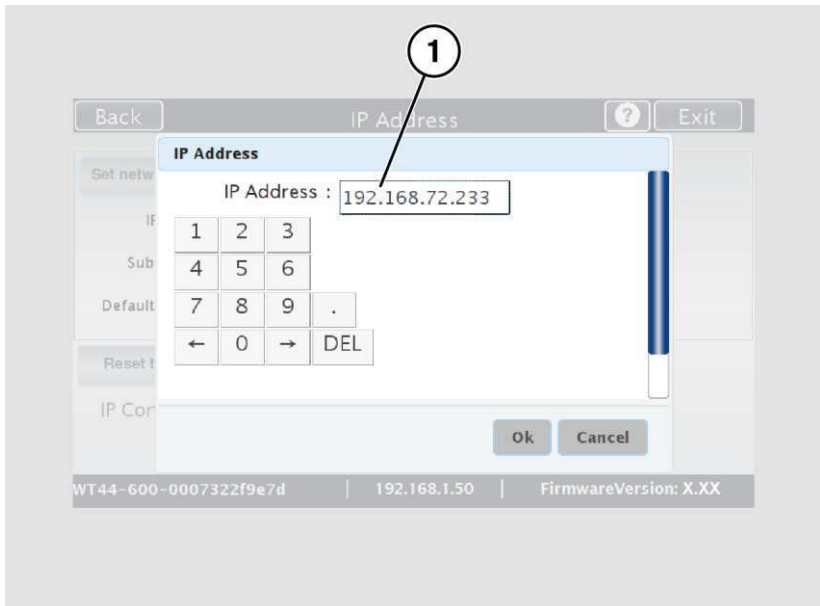

- To delete a digit, move the cursor to the right, behind the digit to be deleted and tap DEL (1).

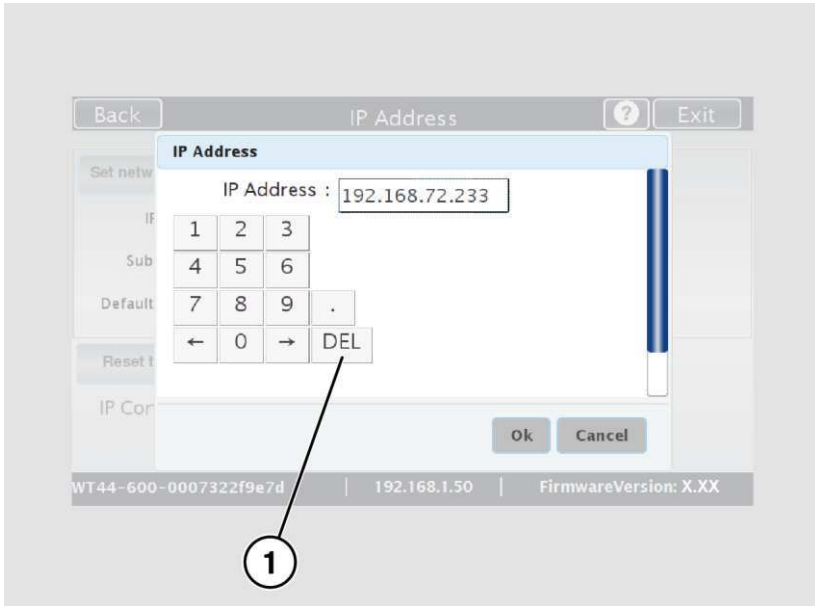

The arrow keys left (1) and right (2) next to the number "0" move the cursor within the chosen row.

- To complete the entry, press OK (3).
- Perform the settings for gateway and subnet mask in the same way.

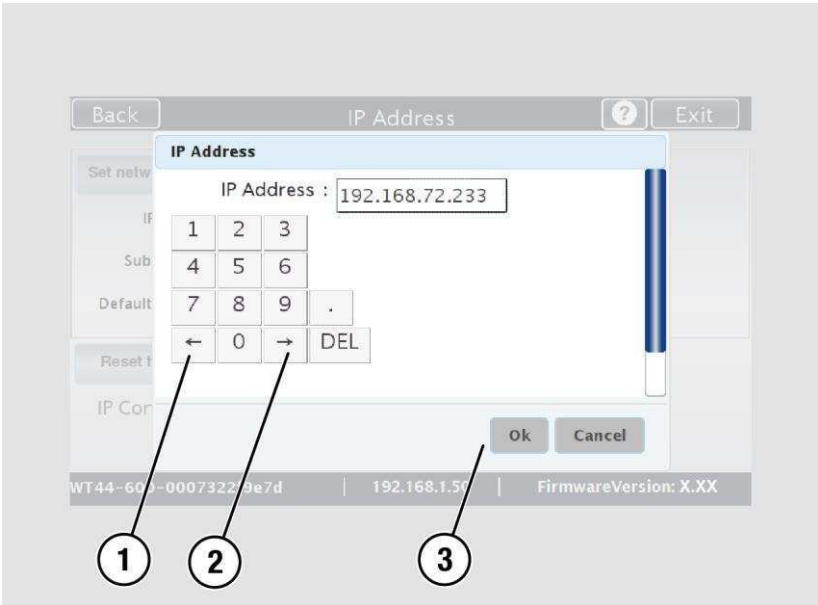

## Perform Setup

- To save the network settings, tap SET NETWORK SETTINGS (2).
- To return to the previous submenu, tap BACK (1).
- To return to the "Start screen", tap EXIT (3).

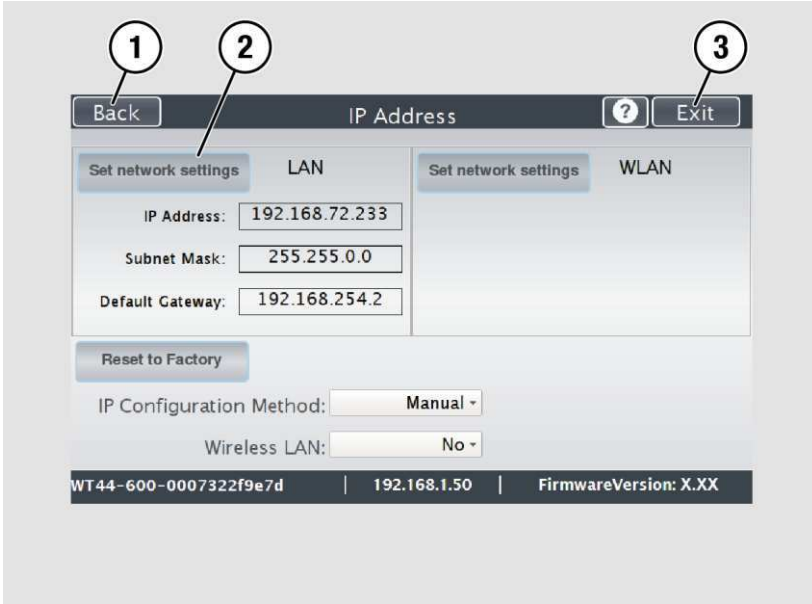



### Automatically Assign the IP Address

To automatically assign the IP address, proceed as follows:

- On the "Setup Menu" screen, tap on IP Address (1).

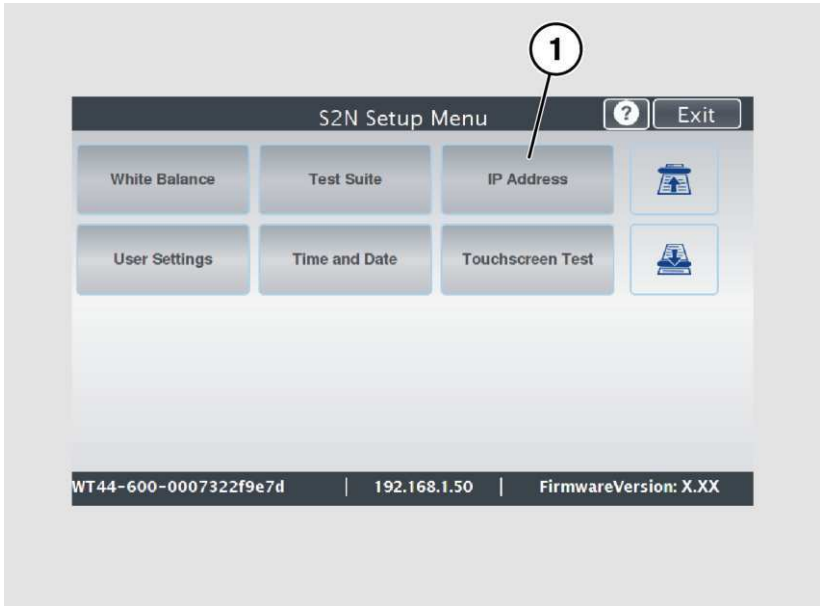

## Perform Setup

- In the selection menu "IP Configuration Method", select the "DHCP" (3) entry.
- To return to the previous submenu, tap BACK (1).
- To return to the "Start screen", tap EXIT (2).

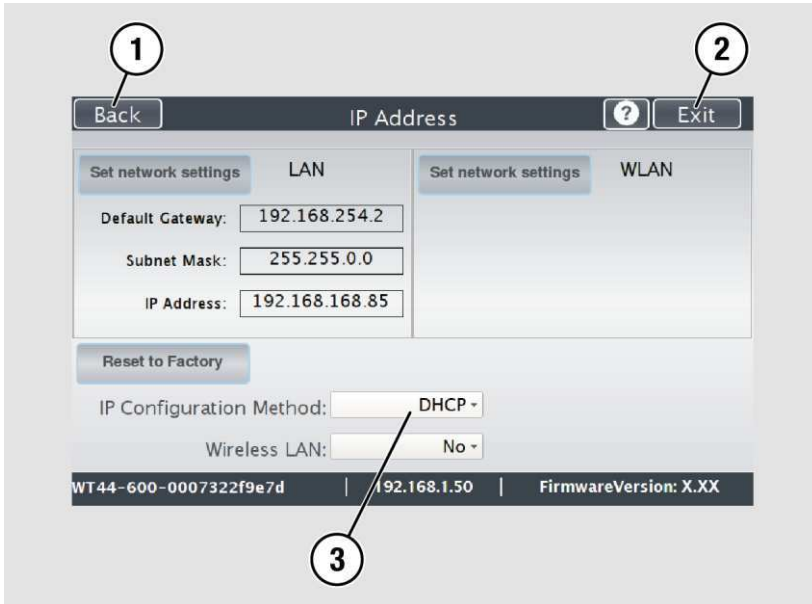

## Modify User Settings

- On the "Setup Menu" screen, tap on USER SETTINGS (1).

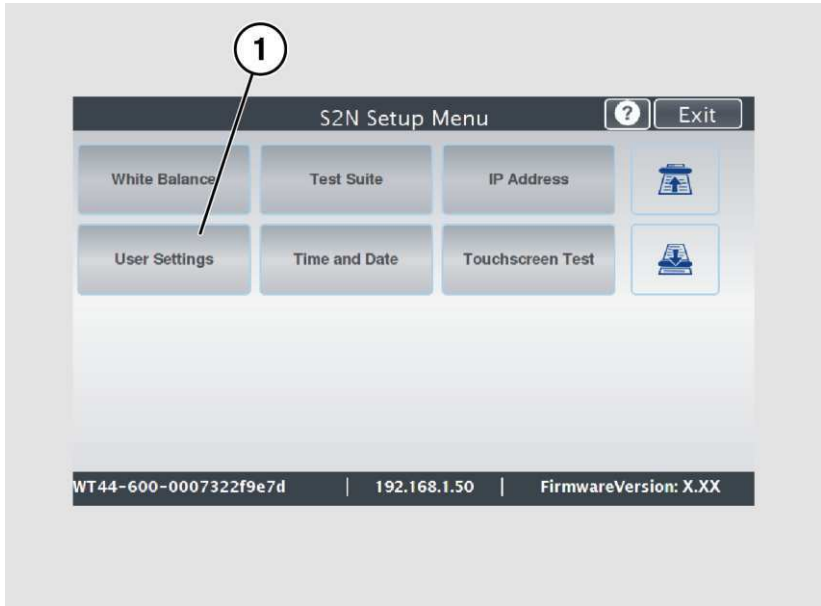

The "User Settings" screen is displayed.

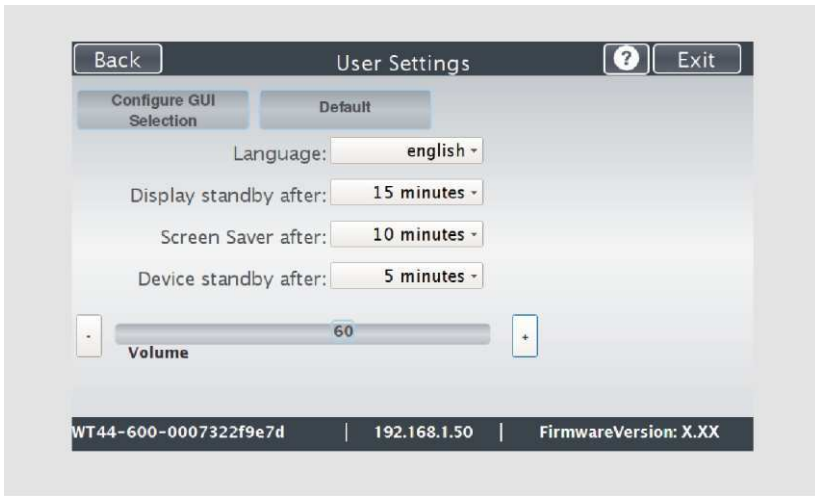

- |                          |  |
|--------------------------|--|
| Configure GUI Selection: | Open the submenu for setting the application in the start screen   |
| Default:                 | The scanner default settings will be established again   |
| Language:                | Select language  |
| Display standby after:   | Define the period of inactivity, until an optional external monitor and the touchscreen switch to the standby mode |
| Screen Saver after:      | The period of inactivity is defined until the screen saver is activated  |
| Device standby after:    | The period of inactivity is defined until the scanner goes into standby mode                                       |
| Volume:                  | Adjust the volume of system sounds   |

## Select Language

To select the language, proceed as follows:

- Tap the on the selection arrow of the selection menu "Language" to display the list of languages.
- Tap the desired language (2).
- To return to the previous submenu, tap BACK (1).
- To return to the "Start screen", tap EXIT (3).

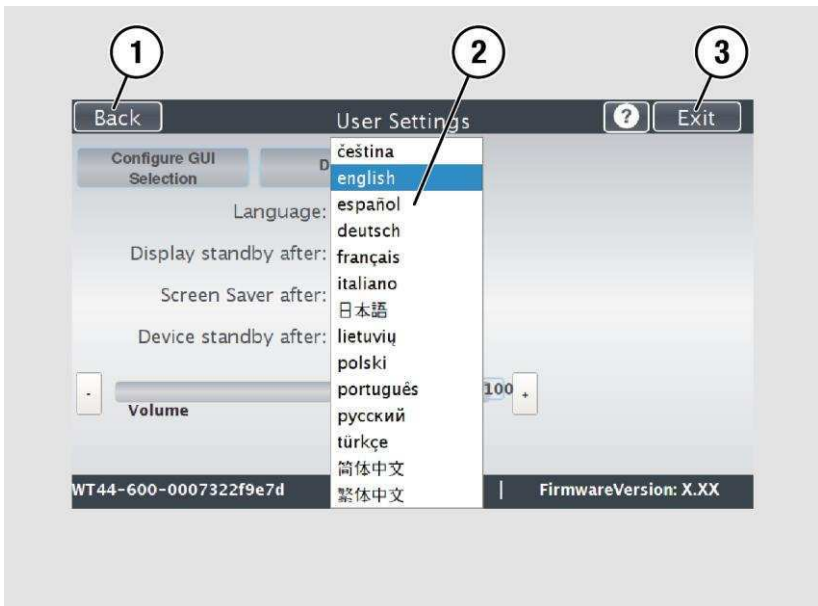

### Set Standby Times

To set the standby times, proceed as follows:

- Tap the selection arrow of the selection menu.
- Tap on the desired entry (2).
- Perform the settings for the screen saver and the device standby in the same way.
- To return to the previous submenu, tap BACK (1).
- To return to the "Start screen", tap EXIT (3).

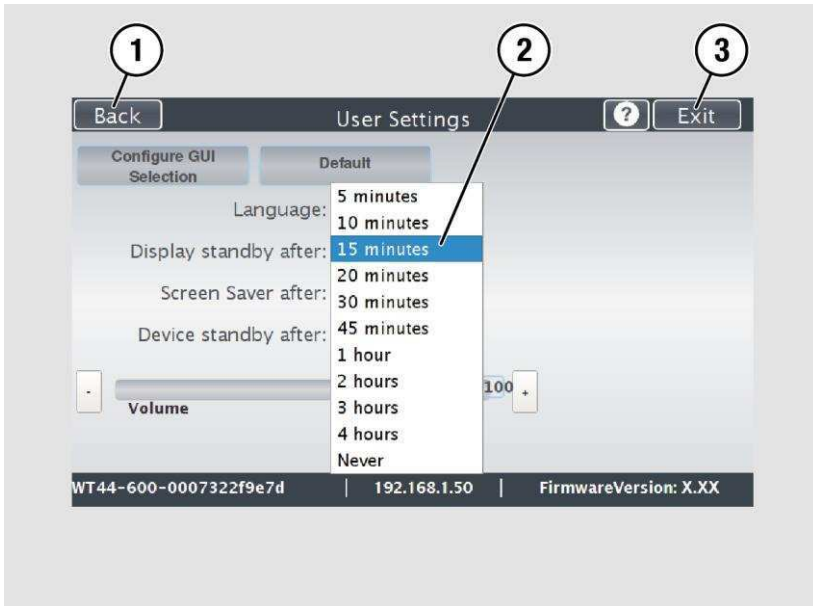

## Adjust Volume

To adjust the volume of the system sounds of the scanner, proceed as follows:

- Slide the volume control (4) to the desired position.

In the "0%" setting, system sounds are not audible. In the "100%" setting the maximum volume is reached.

Alternatively, you can also adjust the volume using the buttons - (5) or + (3).

- To return to the previous submenu, tap BACK (1).
- To return to the "Start screen", tap EXIT (2).

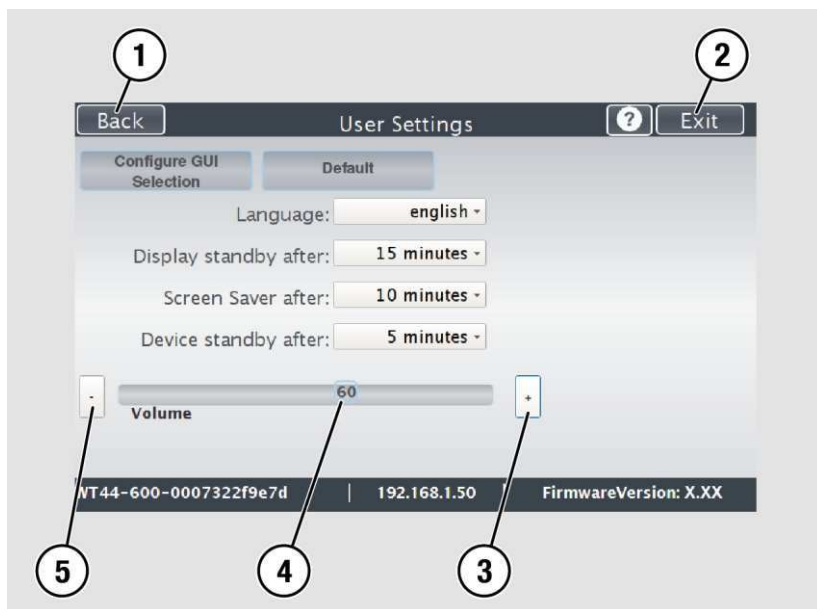

### Configuring the GUI Selection

- Tap the "User Settings" screen on CONFIGURE GUI SELECTION (1).

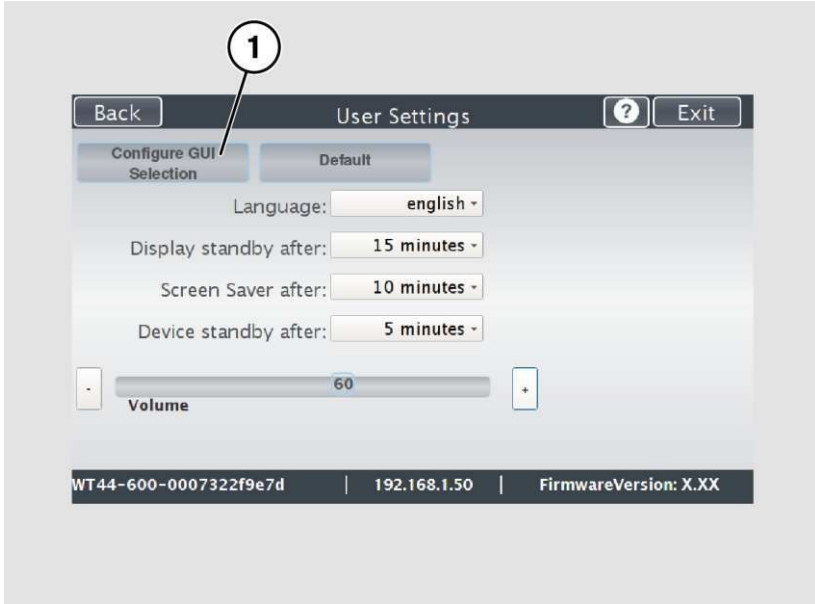



The "Configure GUI Selection" screen is displayed.

This menu displays the "EasyScan" and "ScanWizard" applications, which are available as a standard selection. If, after system start you want to display only one of the applications, proceed as follows:

- Under "Show" (1) disable the box corresponding to the application you do not want to display.

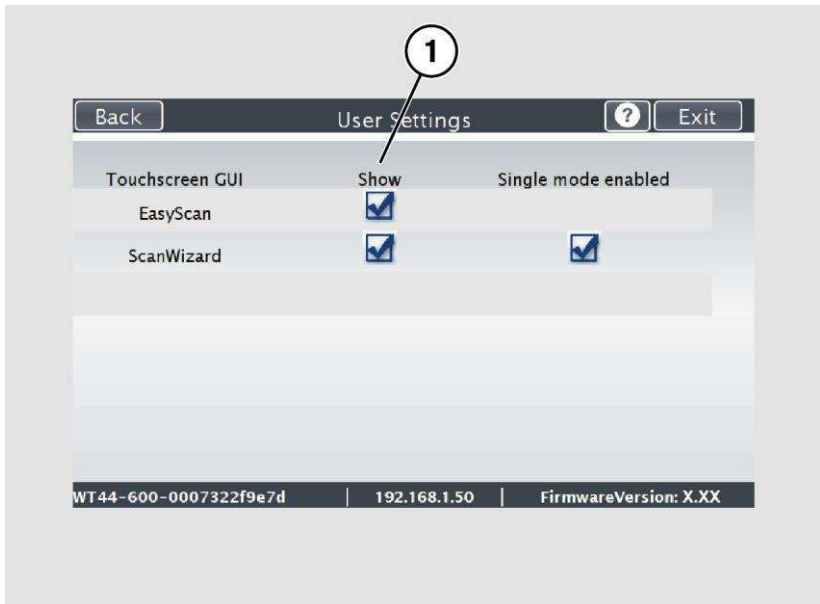

By default, job mode is defined (disable the checkbox "Single mode enabled").

- To start the application in standalone mode, check the checkbox "Single mode enabled" (2).
- To return to the previous submenu, tap BACK (1).
- To return to the "Start screen", tap EXIT (3).



## Set the Time and Date

- On the "Setup Menu" screen, tap on TIME and DATE (1).

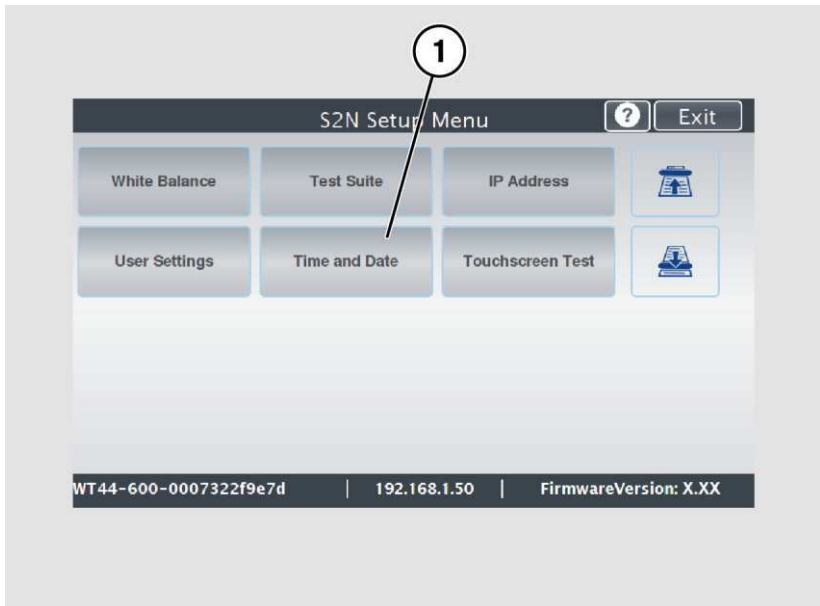

The screen "Time and Date" appears.

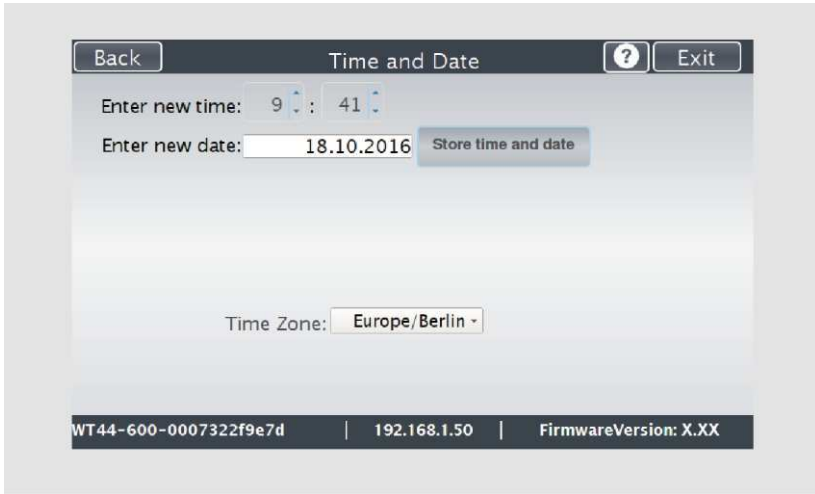

- |                      |   |
|----------------------|---|
| Enter new time:      | Enter hours and minutes with the arrow keys |
| Enter new date:      | Open a calendar to set the date             |
| Store time and date: | Accept the set values                       |
| Time Zone:           | Select a time zone                          |

To set the time, proceed as follows:

- Tap the "Enter new time" field.
- To set the time later, tap the up arrow (2).
- To set the time earlier, tap the down arrow (2).
- To save the modified time, click STORE TIME AND DATE (3).
- To return to the previous submenu, tap BACK (1).
- To return to the "Start screen", tap EXIT (4).

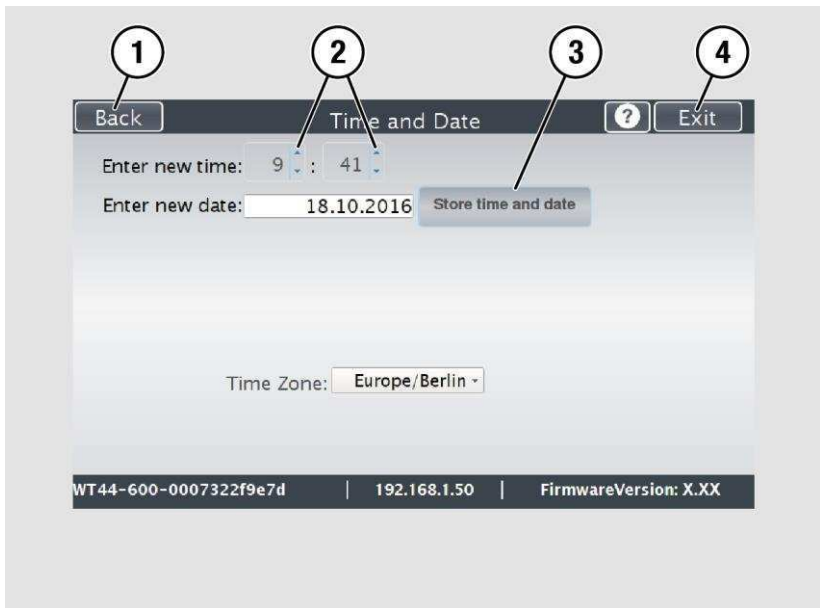

## Perform Setup

To set the date, proceed as follows:

- Tap the "Enter new date" field.

A calendar (3) is displayed.

- Select the appropriate date in the calendar (3).
- To set the month and year, tap the arrow keys (2, 4) at the top of the calendar.
- To set the day, tap the corresponding day in the calendar.
- To save the date, click STORE TIME AND DATE (5).
- To return to the previous submenu, tap BACK (1).
- To return to the "Start screen", tap EXIT (6).

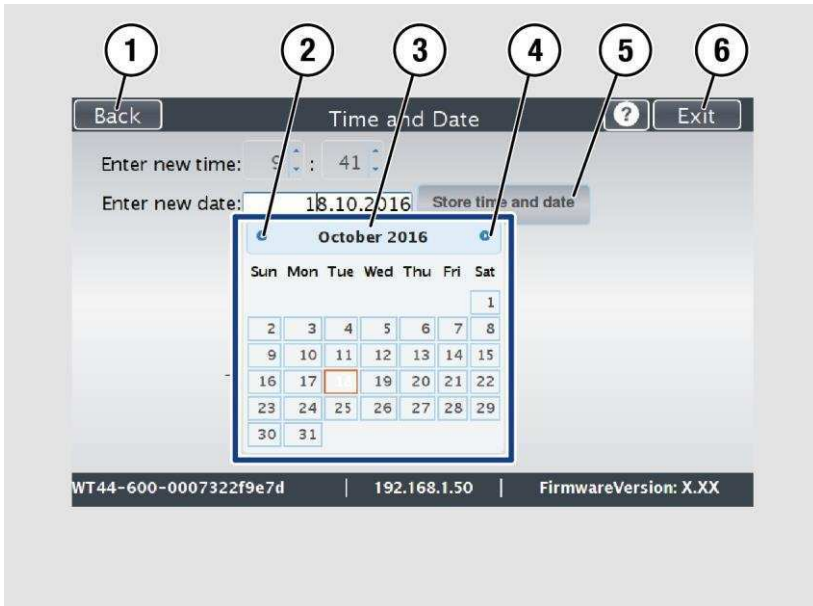

- To select the time zone, tap the selection arrow (4).
- A selection list with available time zones is displayed.
- Select the appropriate time zone.
- To save the time zone, click STORE TIME AND DATE (2).
- To return to the previous submenu, tap BACK (1).
- To return to the "Start screen", tap EXIT (3).

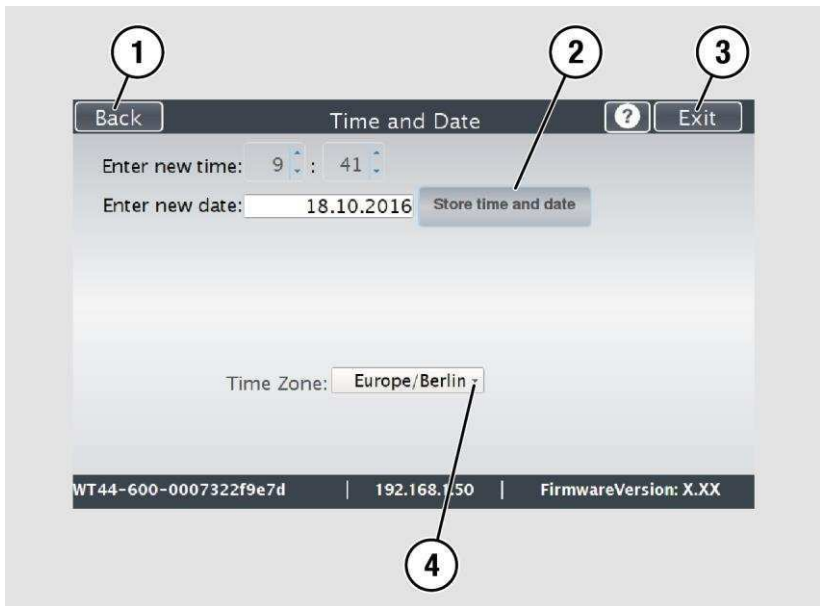

## Perform Test Suite

- On the "Setup Menu" screen, tap on TEST SUITE (1).

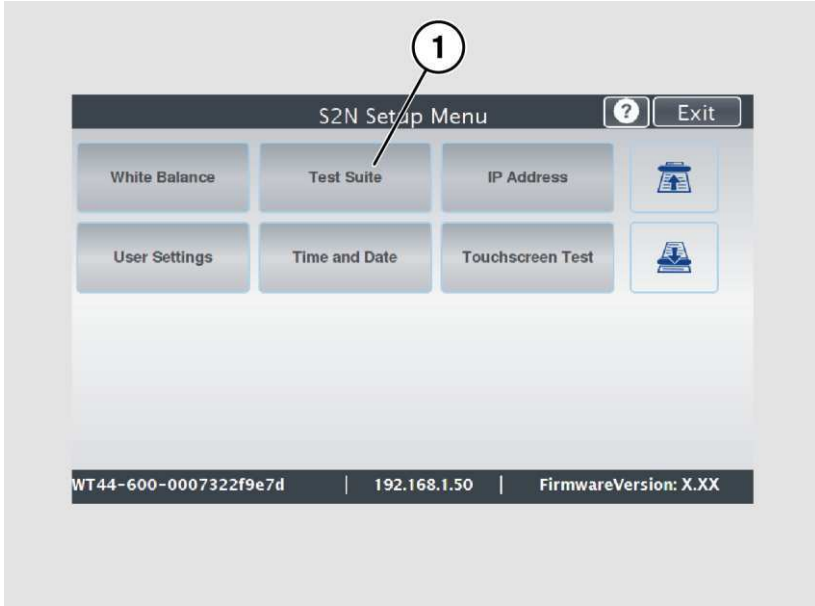



The "Test Suite" screen is displayed.

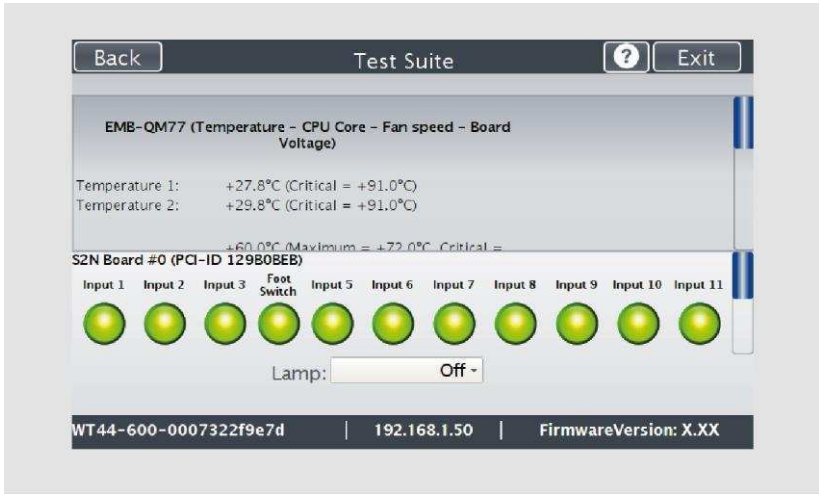

Information about the mainboard:

Display the current values for: Temperature of PCB and CPU cores, fan speed, PCB voltages

Information about the inputs:

Inputs will always appear green

Information on end position switches, foot switch and power button:

When the end position switches, foot switch or the power button is pressed, the display changes from green to red, for as long as the switch or the button is pressed

Information about LED lamps:

Check function: Lamp On, Top, Bottom, Default, Off

### Test the LED Lamps Functionality

- To check whether the LED lamps work properly, select from the "Lamp" menu the entry "Lamp On" (3).

The LED lamps are illuminated.

- To return to the previous submenu, tap BACK (1).
- To return to the "Start screen", tap EXIT (2).

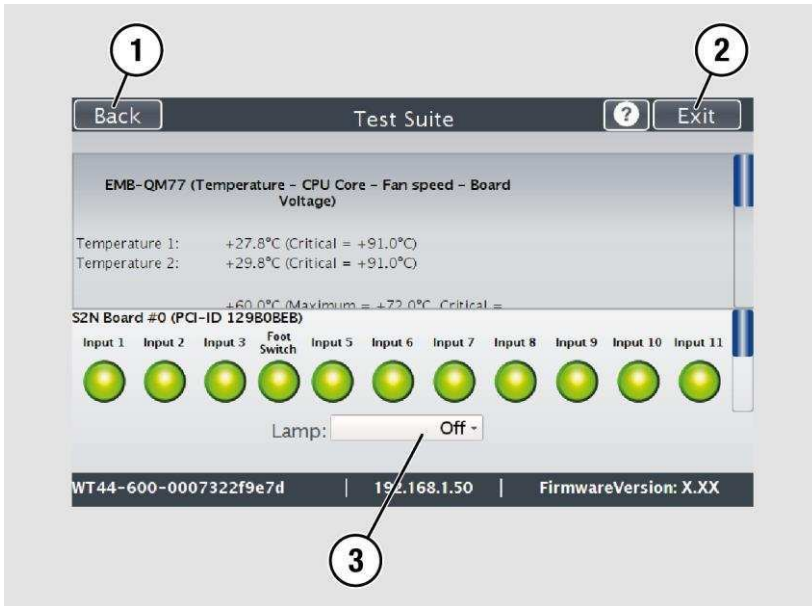

### Test the Optional Foot Switch Functionality

- To check whether the actuation of the foot switch is detected by the system, press down the connected foot switch.

The field "Foot Switch" (3) is shown in red. Pressing the foot switch is detected by the system.

- To return to the previous submenu, tap BACK (1).
- To return to the "Start screen", tap EXIT (2).

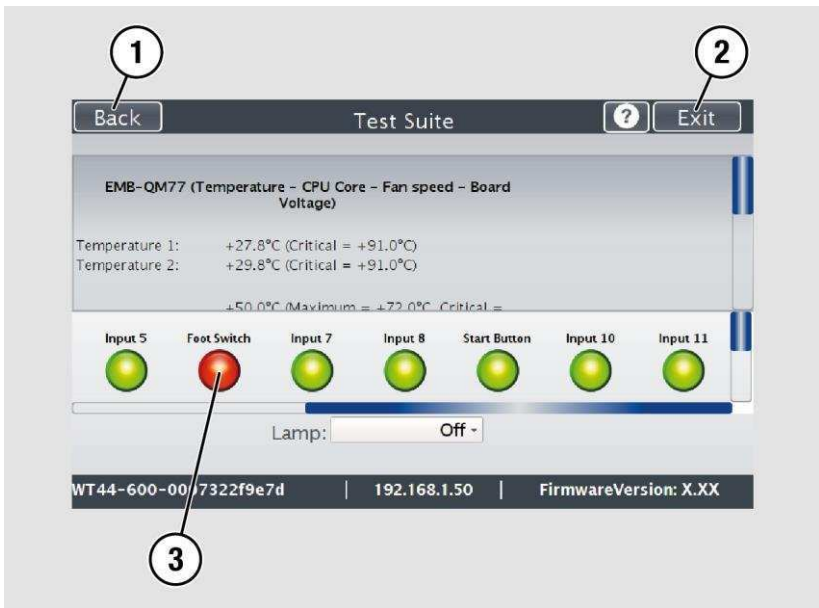

### Test the Power Button Functionality

- To check whether pressing the power button is recognized by the system, press and hold the power button for one or two seconds.

The field "Start Button" (3) is shown in red. Pressing the power button is detected by the system.

- To return to the previous submenu, tap BACK (1).
- To return to the "Start screen", tap EXIT (2).

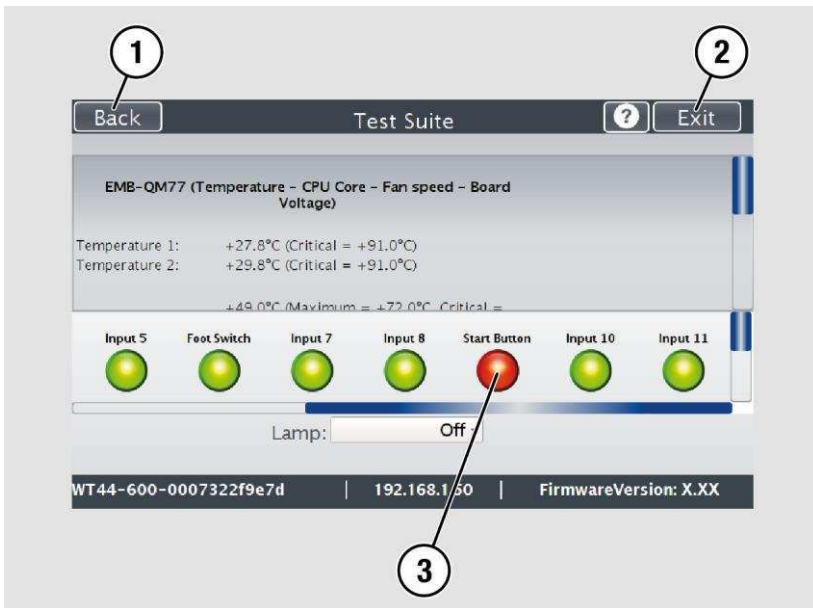

## Touchscreen Test

To check the functionality of the touchscreen when touched, proceed as follows:

- On the "Setup Menu" screen tap on TOUCHSCREEN TEST (1).

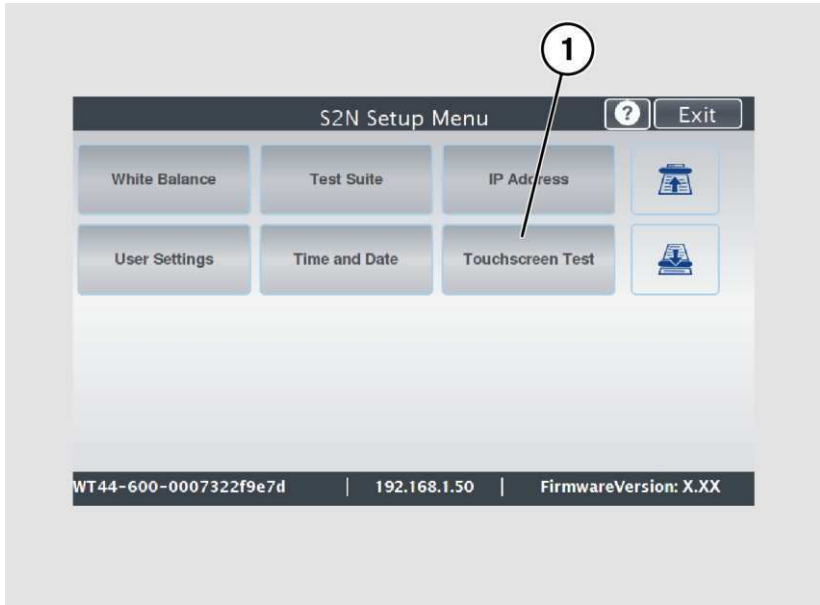

The "Touchscreen test" screen is displayed.

➤ Tap with your finger on the corresponding screen (2).

The cross-lines must occupy the same position as the finger.

➤ To end the "Touchscreen test", tap STOP TOUCHSCREEN TEST (1).

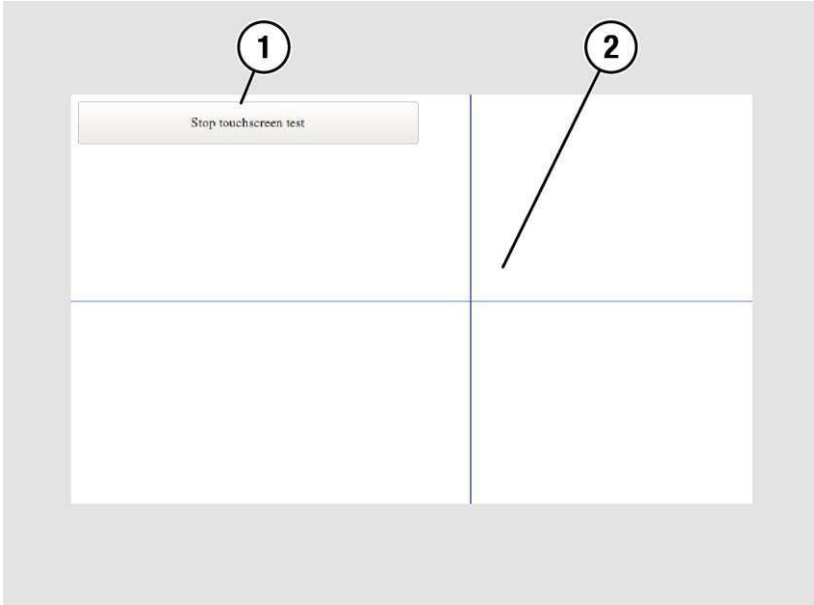

The "Start screen" is displayed.

## Technical Specifications

### WideTEK® 36/44/48 Scanner Specification

#### Optical System WideTEK® 36

Maximum document size	970 mm / 38,2 inch
Scan width	915 mm / 36 inch
Scanner resolution	1200 × 1200 dpi (optional 9600 × 9600 dpi interpolated)
Optical resolution	1200 × 600 dpi
Pixel size	9,3 × 9,3 μm
Sensor type	3 x Tri-color CCDs, encapsulated and dust-proof
Color depth	16 bit grayscale (internal resolution) 48 bit color (internal resolution)
Sensor resolution	67.500 pixels (3 x 22.500)
Scan modes	24 bit color, 8 bit color indexed, 8 bit grayscale, bitonal, halftone
File formats	Multipage PDF (PDF/A) and TIFF, JPEG, JPEG 2000, PNM, PNG, BMP, TIFF (Raw, G3, G4, LZW, JPEG), AutoCAD DWF, JBIG, DjVu, DICOM, PCX, Postscript, EPS, Raw data

#### Illumination WideTEK® 36

Light source	Two lamps with white LEDs, integrated optical diffusor
Warm up time of the lamps	None. Maximum brightness after switching on.
Temperature induced change	None
UV / IR radiation	None
Lifetime of the LEDs	50,000 hours (typically)

**Optical System WideTEK® 44**

Maximum document size	1300 mm / 51.2 inch
Scan width	max. 1118 mm / 44 inch
Scanner resolution	1200 × 1200 dpi (optional 9600 × 9600 dpi interpolated)
Optical resolution	1200 × 600 dpi
Pixel size	9,3 × 9,3 μm
Sensor type	4 x Tri-color CCDs, encapsulated and dust-proof
Color depth	16 bit grayscale (internal resolution) 48 bit color (internal resolution)
Sensor resolution	90.000 pixels (4 x 22.500)
Scan modes	24 bit color, 8 bit color indexed, 8 bit grayscale, bitonal, halftone
File formats	Multipage PDF (PDF/A) and TIFF, JPEG, JPEG 2000, PNM, PNG, BMP, TIFF (Raw, G3, G4, LZW, JPEG), AutoCAD DWF, JBIG, DjVu, DICOM, PCX, Postscript, EPS, Raw data

**Illumination WideTEK® 44**

Light source	Two lamps with white LEDs, integrated optical diffusor
Warm up time of the lamps	None. Maximum brightness after switching on.
Temperature induced change	None
UV / IR radiation	None
Lifetime of the LEDs	50,000 hours (typically)



**Optical System WideTEK® 48**

Maximum document size	1270 mm / 50 inch
Scan width	max. 1219 mm / 48 inch
Scanner resolution	1200 × 1200 dpi (optional 9600 × 9600 dpi interpolated)
Optical resolution	1200 × 600 dpi
Pixel size	9,3 × 9,3 μm
Sensor type	4 x Tri-color CCDs, encapsulated and dust-proof
Color depth	16 bit grayscale (internal resolution) 48 bit color (internal resolution)
Sensor resolution	90.000 pixels (4 x 22.500)
Scan modes	24 bit color, 8 bit color indexed, 8 bit grayscale, bitonal, halftone
File formats	Multipage PDF (PDF/A) and TIFF, JPEG, JPEG 2000, PNM, PNG, BMP, TIFF (Raw, G3, G4, LZW, JPEG), AutoCAD DWF, JBIG, DjVu, DICOM, PCX, Postscript, EPS, Raw data

**Illumination WideTEK® 48**

Light source	Two lamps with white LEDs, integrated optical diffuser
Warm up time of the lamps	None. Maximum brightness after switching on.
Temperature induced change	None
UV / IR radiation	None
Lifetime of the LEDs	50,000 hours (typically)

## Ambient Conditions

Ambient temperature during operation	+5 to +40 °C
Storage temperature	0 to +60 °C
Relative humidity	20 to 80% (non-condensing)
Noise development	≤ 35 dB(A) (Scanning) ≤ 25 dB(A) (Standby)

## Electrical Data

### External Power Supply

Input voltage	100–240 Vac
Frequency	47–63 Hz
Output voltage	24 Vac
Output current	6,25 A
ECO Standard	CEC Level VI

### Scanner

Input voltage	24 V DC
Input current (fused)	max. 5 A

### Power consumption WideTEK® 36

Sleep mode	≤ 0,5 W
Standby mode	ca. 5,2 W
Ready to scan	< 50 W
Scanning	< 95 W

### Power consumption WideTEK® 44/48

Sleep mode	≤ 0,5 W
Standby mode	ca. 6,5 W
Ready to scan	< 60 W
Scanning	< 120 W

### Document specifications

Document length	up to 500 m / 20.000 inch <sup>1</sup>
Paper weight	any
Document thickness	2,5 mm / 0,1 inch max.

<sup>1</sup>The maximum document length depends on the scan resolution and the scan mode.

### Dimensions and Weight WideTEK® 36

Scanner (H × W × D)	228 x 1095 x 507 mm
Scanner with floor stand (H × W × D)	1070 x 1095 x 507 mm
Scanner weight	43 kg
Floor stand weight / including the paper catch	18,5/20,7 kg
Transport box (H × W × D)	470 x 1200 x 800 mm
Weight, ready to ship	80 kg
Transport box - BDL <sup>2</sup> (H × W × D)	670 x 1200 x 800 mm
Weight, ready to ship - BDL	125 kg

<sup>2</sup>Bundled scanner system

## Dimensions and Weight WideTEK® 44/48

Scanner (H x W x D)	228 x 1425 x 507 mm
Scanner with floor stand (H x W x D)	1070 x 1425 x 507 mm
Scanner weight	53 kg
Floor stand weight / including the paper catch	20/22 kg
Transport box (H x W x D)	470 x 1600 x 800 mm
Weight, ready to ship	100 kg
Transport box - scanner BDL <sup>2</sup> (H x W x D)	670 x 1600 x 800 mm
Weight, ready to ship - scanner BDL	151 kg

<sup>2</sup>Bundled scanner system

End of document