

**MICROTEK**

# A1 Large-Format Scanner

## **LS-3800**

---

### **User's Manual**

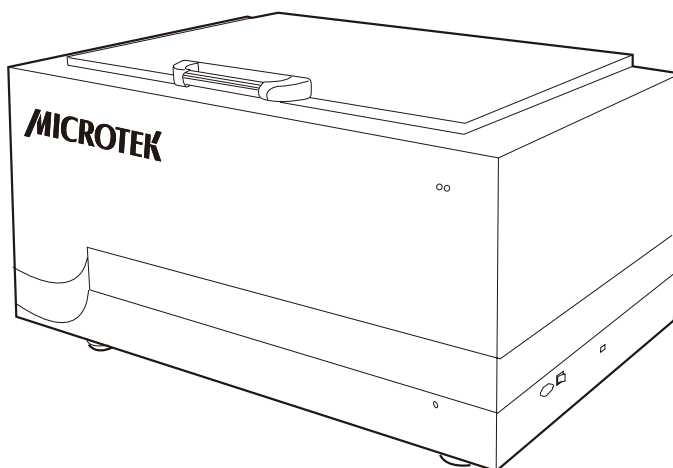

## **Preface**

### **Copyright**

© 2016, Microtek International, Inc., all rights reserved. This document may not be reproduced or copied in any way, stored electronically, or translated into any language, without the permission of Microtek International, Inc.

### **Trademarks**

Microtek, ScanMaker, ArtixScan, ScanWizard and ColoRescue are trademarks or registered trademarks of Microtek International, Inc. All other trademarks or registered trademarks are the property of their respective holders. Specifications, software and hardware bundles are subject to change without notice. Not responsible for typographical errors.

### **Disclaimer**

The contents of this manual have been checked carefully for accuracy, and every effort has been made to ensure that there are no errors. However, Microtek makes no guarantee as to the accuracy of the contents of this document and reserves the right to make changes to the contents without prior warning.

I49-005112, A1  
July 2016

Microtek International, Inc.  
No. 6, Industry East Road 3, Science Based Industrial Park, Hsinchu 30075, Taiwan  
Tel: 886-3-5772155, Fax: 886-3-5772598, <http://www.microtek.com>

## Safety Precautions

Before using your scanner, read the following safety guides carefully, which detail the proper operation of the scanner and its accessories to prevent injuries or damage to users or equipment.

### Meanings of Symbol Signs



CAUTION







This indicates hazardous situation which, if not paid attention, could result injury or damage to users or equipment.





WARNING

This indicates hazardous situation which, if not paid attention, could result serious injury or death to users.

### Power Supply:

- 
  - Use a power source only with a power rating specified on the marking label.
- 
  - Ensure to turn off the power of each device before connecting or disconnecting the cables.
- 
  - Insert the plug completely into the outlet, as a loose connection may cause arcing and result in fire.
- 
  - Ensure to hold the plug or connector to disconnect the cable; otherwise, if you pull the cable only, it may damage the core wire and result in fire or electric shock.
- 
  - Place and route the power supply cord such that it is not likely to be walked on or pinched by items placed upon or against them, paying particular attention to the cord near the power plugs, convenience receptacles, and at the point where it exits from the outlet.
- 
  - When the scanner is left unattended and unused for long periods of time, unplug it from the wall outlet.

### Moving and Storing the Scanner:

- 
  - Always ensure that the scanner is stored properly before shipping or moving it. Quick stops, excessive force, and uneven surfaces may cause the product to overturn when moving.
- 
  - Do not hit or drop the scanner. The scanner may be damaged if it receives a strong jolt, which may result in fire or electric shock if the scanner is used without being repaired.
- 
  - Do not place the scanner on any slippery, slanted, or unstable surface. The product may slide or fall, causing serious injury to people as well as serious damage to the product.

- ⚠️ ⚡ Do not use the scanner near water. Never spill liquid of any kinds on the product, or it may result in electric shock or other hazards.
- ⚠️ ⚡ This scanner should be situated away from heat sources such as radiators, heat registers, stoves, or other products (including amplifiers) that produce heat.
- ⚠️ Do not store the scanner in which it may be exposed to direct sunlight.

### Using the Scanner

- ⚠️ ⚡ When opening the upper cover of the scanner, make sure that it has been lifted to a proper position. The quick and sudden drop of the upper cover could result injury or damage to users or equipment.
- ⚠️ When opening or closing the upper cover of the scanner, please use it carefully and watch out for pressing your hands.

Lift the upper cover of the scanner to a proper position to avoid its sudden drop.

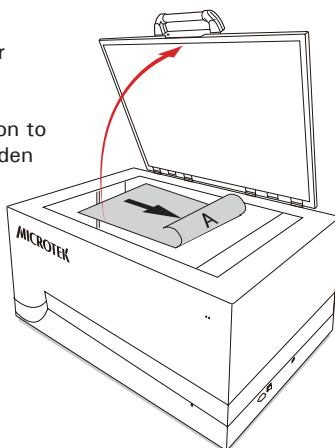

Attention: When opening or closing the upper cover of the scanner, use it carefully and watch out for pressing your hands.

### Maintenance and Service:

- ⚠️ When the scanner is going to be cleaned, ensure to turn off the power of each device and unplug the power cable from the AC outlet.
- ⚠️ When you need a repair service, unplug the scanner from the power outlet and consult qualified service personnel.
- ⚠️ When replacement parts are required, use replacement parts that are specified by the manufacturer or have the same characteristics as the original parts.

# Table of Contents

<b>Preface .....</b>	<b>2</b>
<b>Safety Precautions .....</b>	<b>3</b>
<b>Knowing about Your Scanner.....</b>	<b>7</b>
Features of Your Scanner .....	7
System Requirements .....	8
Taking a Closer Look .....	9
<b>Initiate Setup.....</b>	<b>10</b>
Step 1: Unpacking Package Contents .....	10
Step 2: Installing the Software.....	12
Step 3: Keeping the Scanner in Place.....	12
Step 4: Unlocking the Scanner.....	14
Step 5: Connecting the Scanner.....	15
To the Power Cord .....	15
To the Hi-Speed USB Cable .....	15
<b>Scanning the Materials.....</b>	<b>16</b>
Positioning the Materials .....	16
Using ScanWizard Graph Software .....	17
Using Optional ScanWizard DTG Software .....	20
Using Optional ScanWizard Cubi Software .....	22
<b>Cleaning the Glass Surface .....</b>	<b>24</b>
<b>Maintenance .....</b>	<b>24</b>
<b>Appendix .....</b>	<b>25</b>
Troubleshooting .....	25
Specifications .....	26



# Knowing about Your Scanner

The LS-3800 scanner is professional scanner exclusively designed for transferring large-format originals into digital formats. The scanner can capture large-size graphs quickly, such as maps and blueprints, providing the professionals a convenient method to digitize the originals for the electric data storage.

## Features of Your Scanner

The scanner comes with several important features, including the following:

- Energy-saving two-way LED light source — Adopting two-way LEDs as the light source, when the scanner is detected by the system, there are no requirements for any warm-up time before carrying out the scan, which boots your productivity and reduces energy costs amazingly. With its stable performance, the image quality will remain consistent even after used for a certain period of time.
- Elevating Knobs — There are four Elevating Knobs at the bottom of the scanner, which ensure that the scanner can be set on the ground stably and strengthen the safety and convenience of using.
- Easy to operate, clean and maintain — The scanner requires virtually no routine maintenance and no daily cleaning, which is ideal for a busy working environment.
- Microtek ScanWizard Graph software — ScanWizard Graph is software exclusively designed for scanning and saving large-format graphs. It is provided with series of advanced functions and tools, providing instant and complete helps to users who can therefore control the scanner easily and get the best image results. It is ideal for advertising, printing, graphic-designing, library management institutes, image processing, architectures and constructions.
- Optional Microtek ScanWizard DTG software\* — ScanWizard DTG is specifically designed for digital textiles and printings, offering many image improving functions, such as Texture Smoothing, Luminosity Sharpen and Detail Enhancement. It is good for using on printing digital patterns in textile, printing, dyeing and ready-to-wear industries.
- Optional Microtek ScanWizard Cubi software\* — ScanWizard Cubi is exclusively designed for capturing stereogram. It allows you to set the direction of light projecting according to your specific requirements and helpful for capturing vivid and lifelike plane or stereoscopic images. It is perfect for using in manufacturing and image processing industries.

*\* Microtek ScanWizard DTG and ScanWizard Cubi are optional scanning software depending on the scanner configuration that you purchased.*

## System Requirements

- DVD-ROM drive (for installing software)
- Color display with 24-bit color output capability
- 8 GB RAM or more recommended
- Intel Core i5 processor at 3.0 GHz PC or higher with USB 2.0 port
- Microsoft Windows 7 (64-bit), 8 (64-bit) or 10 (64-bit)



## Taking a Closer Look

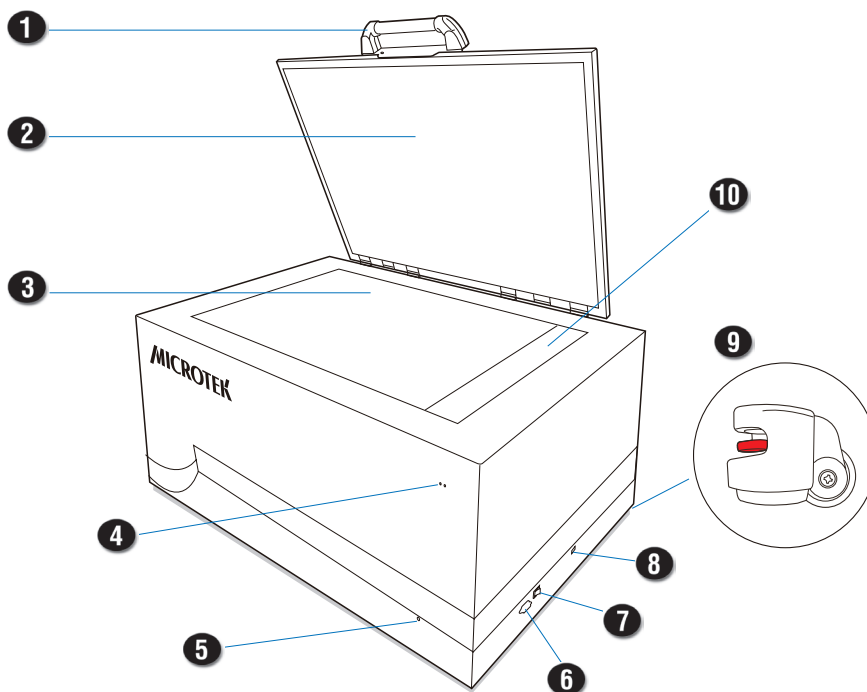

No.	Names of Parts	Functions of Parts
1	Handle	Holds to open or close the upper cover of the scanner.
2	Upper Cover	Covers the scanner bed.
3	Scan Bed	The place where the scanned original is positioned.
4	Indicator (Green)	Displays the status of the scanner.
5	Safety Locks (2)	Locks the scanner cartridge.
6	Power Connector	Connects the scanner to the power adapter.
7	Power Button	Turns the scanner on or off.
8	Hi-Speed USB Port	Connects the Hi-Speed USB (USB 2.0) cable to the computer.
9	Casters with Locks (4)	Used to move or lock the scanner.
10	Ruler	Used as a reference to position a scanned document in center.

# Initiate Setup

## Step 1: Unpacking Package Contents

After unpacking your scanner package, please check for the major components listed below.

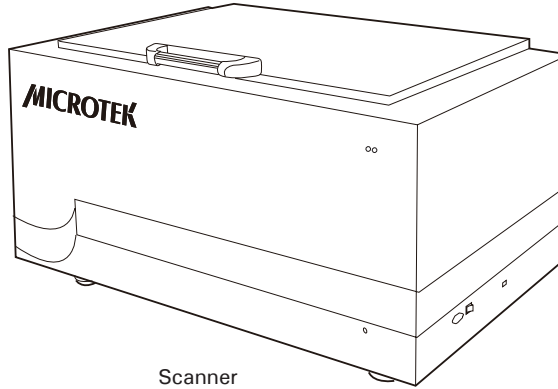

Scanner

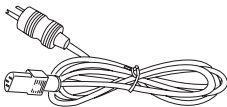

Power cord

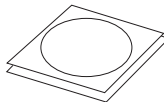

Software CD/DVD

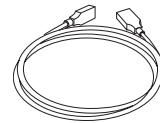

Hi-Speed USB cable

## Step 2: Installing the Software

**Important:** You must install all software before connecting your scanner. Always close any open programs and turn off Anti-virus utilities before installing software.

1. Turn on your computer.
2. Place the Microtek Software CD/DVD into a drive.
3. Follow the on-screen instructions to install the driver and software.

*Note: If the Microtek Software Installer screen does not come up automatically, double-click the following in succession: "My Computer"; the CD/DVD-ROM icon; then Setup.exe to start the installer program.*

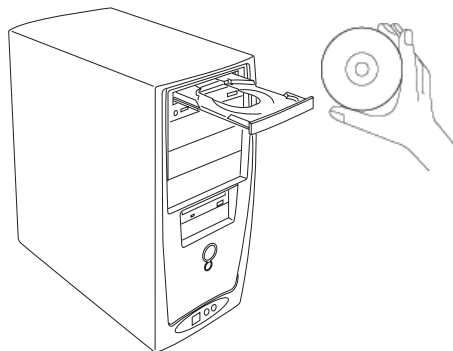

4. Click EXIT on the Microtek Software Installer screen when all the software has been installed.
5. Restart your computer.

*Note: If the system displays a message "Found a new hardware" after the computer is restarted, please select the installer program automatically.*

### Drivers & Software Upgrades

After you finish the installation of software, if you found that the installed drivers and software cannot run your product or your computer system properly later, please go to the Microtek Download Service site at [ww7.microtek.com.tw/service.php](http://ww7.microtek.com.tw/service.php) to download and install any updates you may require.

For additional information about Microtek products, please visit our website at [www.microtek.com](http://www.microtek.com).

### Step 3: Keeping the Scanner in Place

There are four casters at the bottom of the scanner, which are designed for moving the scanner in convenience. In order to avoid the sudden movement of the scanner which may result injury to users, please put your scanner on a flat and stabilized ground before using.

1. Look for and locate the Elevating Knobs next to the four casters at the bottom of the scanner.

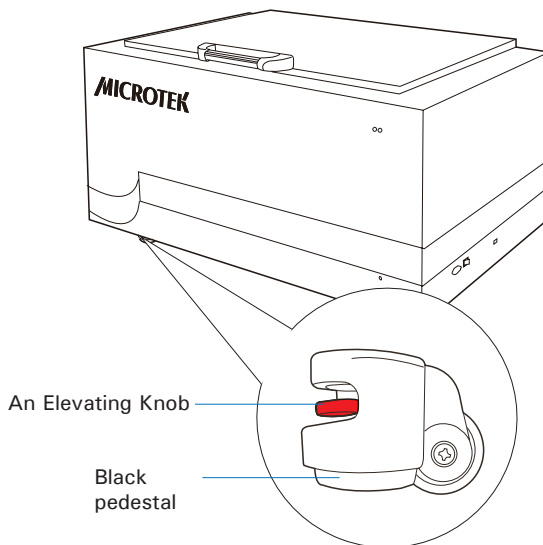

2. Spin a red gear of the Elevating Knob clockwise to move down a black pedestal located at the bottom of the Elevating Knob. Continually, spin the red gear until the black pedestal is stabilized on the ground.

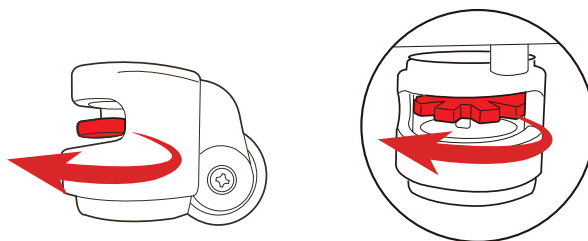

Spin the Elevating Knob clockwise and the black pedestal will be moved down and then touched the ground.

3. Repeat the step 2 until four black pedestals have been moved down and stabilized on the ground.

*Note: When you have a need to spin Elevating Knobs and to rise up black pedestals from the ground, follow the steps below:*

- 1. Spin the red gear of the Elevating Knob counterclockwise to rise up the black pedestal located at bottom. Continually, spin the red gear until the black pedestal is fully raised from the ground.*
- 2. Repeat the step 1 until four black pedestal have been moved up from the ground.*

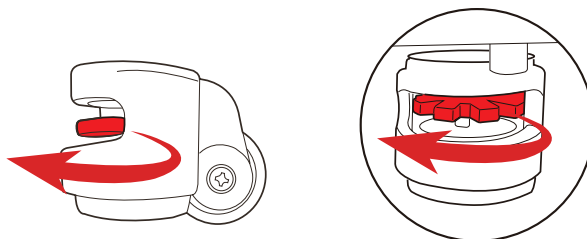

Spin the Elevating Knob counterclockwise until the black pedestal is moved up from the ground.

## Step 4: Unlocking the Scanner

1. Locate two locking screws at the right corner of the front panel of the scanner and at the left corner of the back panel of the scanner.
2. Using a flat-head screwdriver, pass through a round circle at the outer shell of the scanner and insert a hollow side of the locking screw: a) push to the end with force, and b) turn the locking screw counterclockwise 90 degrees to the unlock position.

When successfully unlocked, the screw will push out a little, protruding slightly from the front of the scanner. Also, the pattern of the hollow side of the locking screw will be turned horizontally.

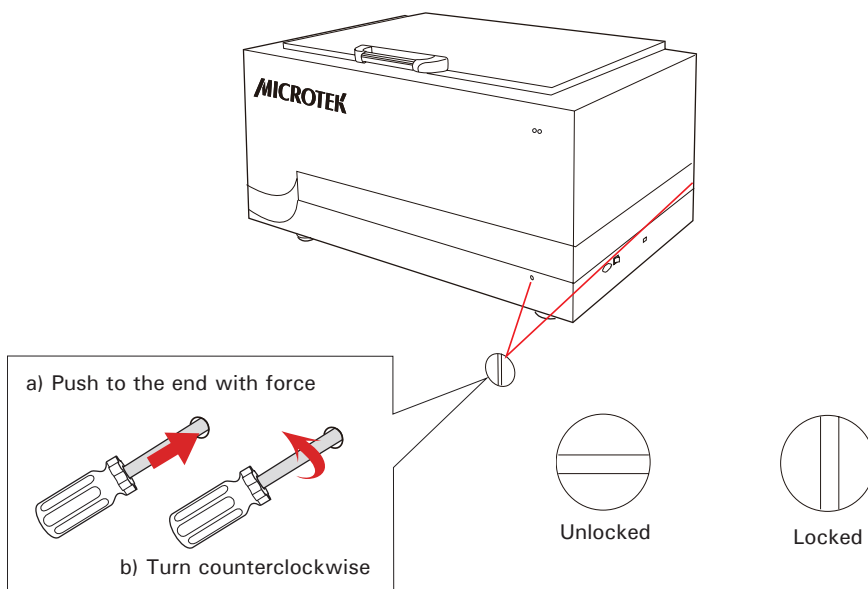

*Note: If you have to transport the scanner, you will need to lock the scanner back. Follow the steps below:*

1. *Turn off the scanner if your scanner is on. Make sure that the power button light (green power light) is off.*
2. *Turn the scanner back on. Make sure that the Hi-Speed USB cables have connected computer with your scanner properly. Then, activate Microtek scanning software program. Make sure that the control panel of the software has been displayed on the screen successfully.*
3. *Using a flat-head screwdriver, pass through a round circle at the outer shell of the scanner and insert a hollow side of the locking screw. Push down with force and turn the locking screw clockwise 90 degrees to the lock position.*
4. *Shut down Microtek scanning software program and turn off your scanner. Hereby, the scanner is ready for transport.*

## Step 5: Connecting the Scanner

### To the Power Cord

1. Connect one end of the power cord to the right side of the scanner.
2. Plug the other end of the power cord into a power source.
3. Press the Power button to turn the scanner on. When the scanner is on, the power button light (the green power light) will be turned on as well.

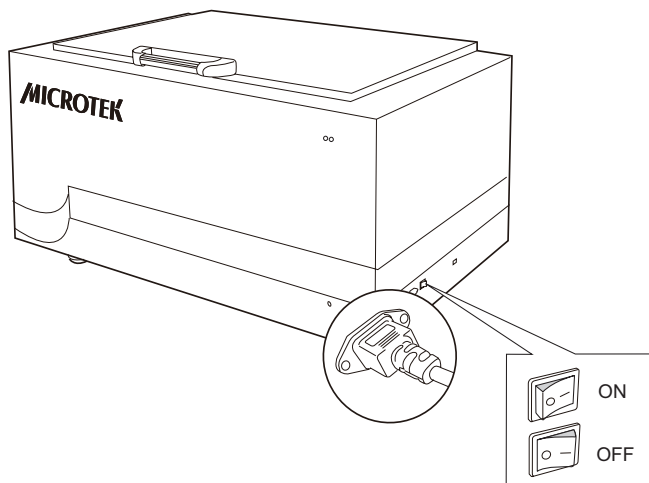

### To the Hi-Speed USB Cable

1. Connect one end of the Hi-Speed USB cable to your computer.
2. Connect the other end of the Hi-Speed USB cable to the scanner.



# Scanning the Materials

## Positioning the Materials

1. Lift up the upper cover of the scanner by holding the handle at the front of the upper cover of the scanner.

*Note:*

- *When opening the upper cover of the scanner, please make sure that you have lift up the upper cover to a proper position in order to avoid the sudden drop of the upper cover due to the weight. It may result injury or damage to users or scanner.*
  - *The numbers of hinges, used to unite the upper cover and scanner's main unit, can be increased or decreased based on the demands of users. The maximum numbers are up to 6 sets. If you have special requirements toward the numbers of hinges, please contact your local sales for details.*
2. Place the material to be scanned face down on the scan bed (scanner glass surface), towards the right of the scanner. Center the top of the original along the ruler on the scanner.
  3. Lower the upper cover of the scanner gently.

*Note: When opening or closing the upper cover of the scanner, watch out for the position of upper cover to prevent pressing and hurting for your hands.*

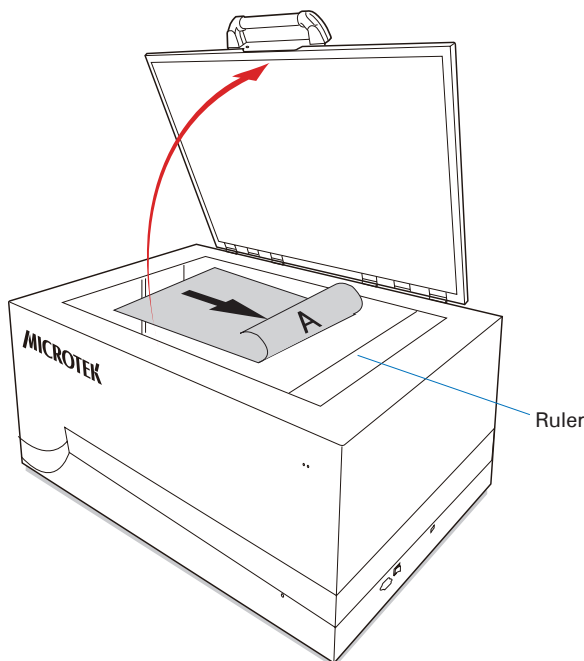



## Using ScanWizard Graph Software



1. Refer to the descriptions in “Positioning the Materials” to place the material to be scanned on the scan bed.
2. Launch **ScanWizard Graph** either as a standalone by clicking on the program icon on the desktop, or by using the File-Import or File-Acquire command from your image-editing program (such as Adobe Photoshop).
  - The first time you launch ScanWizard Graph, you will be prompted to set up color matching for your scanner. If you are not sure about what to do, simply click the OK button to accept the settings. You can always change the settings at a later time.

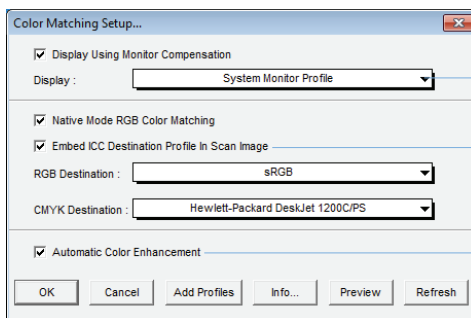

Pertains to how your monitor displays color, relative to the RGB Destination color space

Color Matching features

Improves the contrast and saturation of an image

For more information, see the *Color Matching Setup* section in the *ScanWizard Graph Reference Manual* in the Microtek Software CD/DVD.

3. Go to the Preview window of ScanWizard Graph, and choose **Reflective** from the Scan Material menu.
4. Click the **Overview** button to perform a preliminary scan of the image, which will appear in the Preview window.
5. Select the **Scan Frame** tool from the Toolbar in the Preview window, and choose the area to be scanned by dragging a rectangle around it. You will see a flashing frame (marquee) around the selected area.
6. Click the **Prescan** button to display a detailed image area selected via the Scan Frame tool. A thumbnail of the image appears as well in the Scan Job Queue window.
7. Specify your scanning requirements in the Settings window.
  - a) Select a desired image type.
  - b) Select a desired resolution.
  - c) Adjust the scan frame settings if necessary.

- 8 Adjust image quality if necessary, using the Advanced Image Correction (AIC) tools.
9. If the colors in your materials are faded and needed restoring, check the "Automatic Color Restoration" box in the Settings window.
10. Click the **Scan** (or "**Batch**") button in the Preview window to start scanning.
  - If ScanWizard Graph was launched from an application program, the image is then delivered to your application, where the image can be saved, printed, or edited.
  - If ScanWizard Graph was launched in stand-alone mode, you will be prompted to specify the file attributes for the scanned image after the Scan or Batch button is pressed, such as entering the file name, specifying a folder name of your own, etc. When you have completed the settings, press the Done/Save button, and the scanner will automatically scan and save your image based on your settings.

*Note: For more information about ScanWizard Graph scanning software, see the manual of ScanWizard Graph in the Microtek Software CD/DVD.*

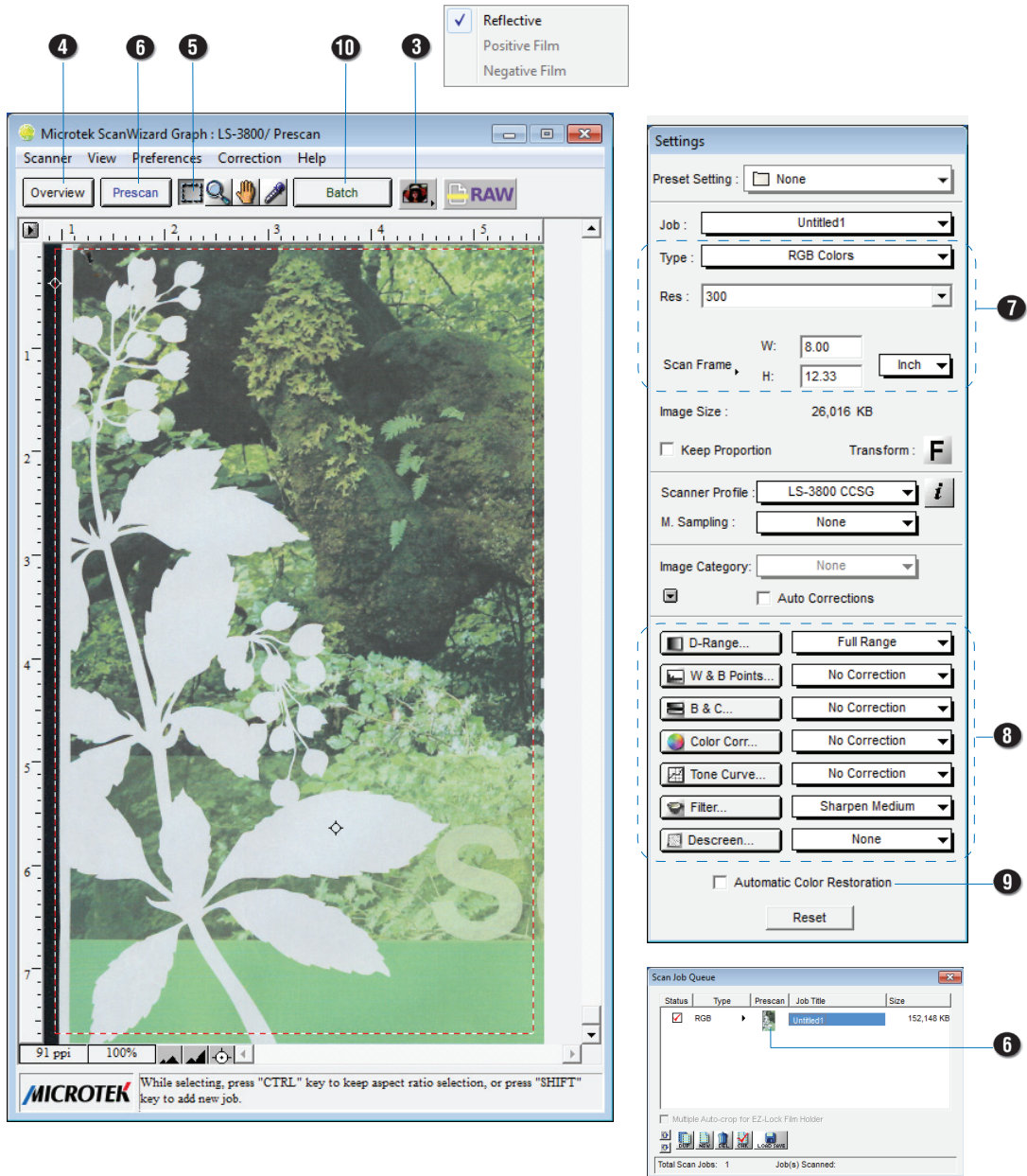

## Using Optional ScanWizard DTG Software

Before using the ScanWizard DTG software, you have to plug the USB Dongle come with your software package into your computer's USB port; otherwise, the ScanWizard DTG cannot be activated.

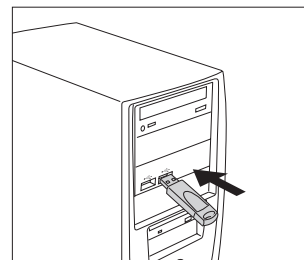

When done, follow the steps below to scan your target.

1. Refer to the descriptions in “Positioning the Materials” to place the material to be scanned on the scan bed.
2. Launch **ScanWizard DTG** as a stand-alone by clicking on the program icon on the desktop.



If ScanWizard DTG is launched, you will see the ScanWizard DTG (AP) interface on the screen.

3. If necessary, click the **Scan Setting** button to bring up the ScanWizard DTG (TWAIN) interface. By there, you can customize your scanning settings.
  - a) Follow the procedure (steps 4 through 9) for “Using ScanWizard Graph Software” section to specify your scanning requirements.
  - b) Click the OK button in the Preview window to close the ScanWizard DTG (TWAIN) interface and return to the ScanWizard DTG (AP) interface.
4. Click the **Scan** button to start scanning.

The ScanWizard DTG will perform the final scan of the image with the default or customized scanning settings you specified in the ScanWizard DTG (TWAIN) interface.

When the scan is done, the scanned image will be displayed in the Thumbnail view window on the left column of the interface.

5. If necessary, adjust and optimize image by using the **Image Adjustment** controls.
  - a) Select a scanned image to be optimized from the Thumbnail view window. When done, the selected image will be displayed in the Navigation window and Index Preview window.
  - b) If necessary, click an area of the image in the Navigation window to display that area in the Index Preview Area .
  - c) Optimize the image by using the provided tools for your needs.
6. When done, click the **Export** button to save the scanned or/and optimized image.

The scanned or/and optimized image can be saved as a file in your selected folder.

*Note: For more information about ScanWizard DTG scanning software, see the manual of ScanWizard DTG in the Microtek ScanWizard DTG CD/DVD.*

### ScanWizard DTG (AP) interface

Click to switch to the ScanWizard DTG (TWAIN) interface. By there, you can customize your scanning settings.

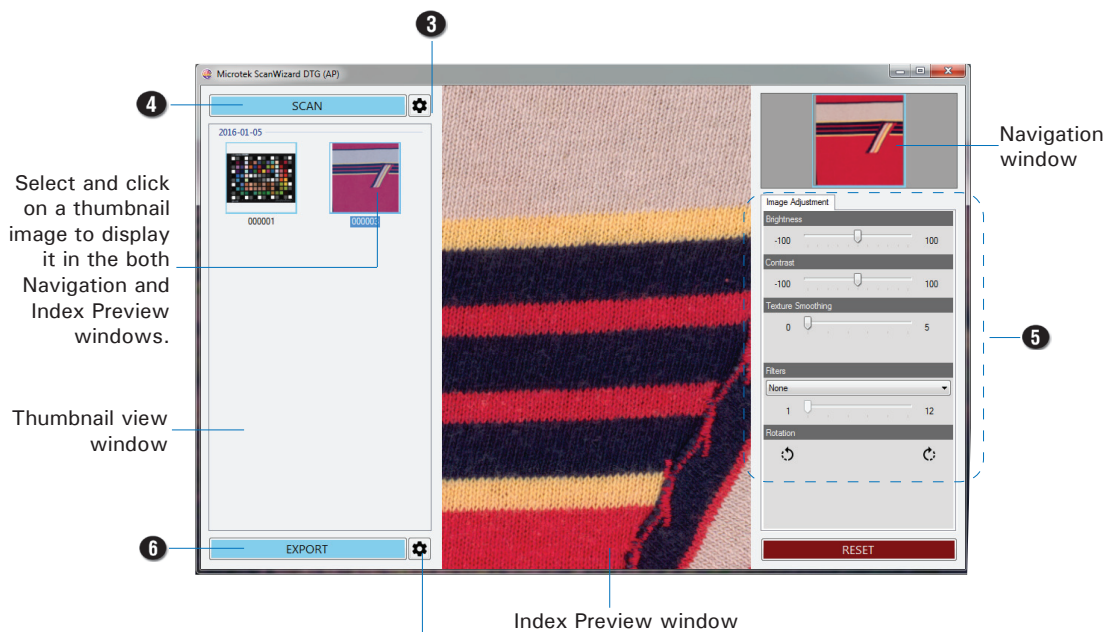

Click it to bring up a dialog box where you can set up file format settings for output image files.

## Using Optional ScanWizard Cubi Software

Before using the ScanWizard Cubi software, you have to plug the USB Dongle come with your ScanWizard Cubi software package into your computer's USB port; otherwise, the ScanWizard Cubi cannot be activated.

When done, follow the steps below to scan your target.

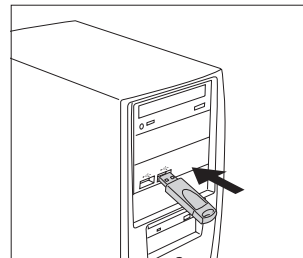

1. Refer to the descriptions in "Positioning the Materials" to place the material to be scanned on the scan bed.
2. Launch **ScanWizard Cubi** as a stand-alone by clicking on the program icon on the desktop.

If ScanWizard Cubi is launched, you will see the ScanWizard Cubi (AP) interface on the screen on the screen.

3. If necessary, click the **Scanner Control** to set the direction of the light projecting. Select **Left**, **Right**, or **All** from the Lamp Settings according to your specific requirements. The default setting is **All**.
4. If necessary, click the **Scan Setting** button to bring up the ScanWizard Cubi (TWAIN) interface. By there, you can customize your scanning settings.
  - a) Follow the procedure (steps 4 through 9) for "Using ScanWizard Graph Software" section to specify your scanning requirements.
  - b) Click the OK button in the Preview window to close the ScanWizard Cubi (TWAIN) interface and return to the ScanWizard Cubi (AP) interface.
5. Click the **Scan** button to start scanning.

The ScanWizard Cubi will perform the final scan of the image with the default or customized scanning settings you specified in the ScanWizard Cubi (TWAIN) interface.

When the scan is done, the scanned image will be displayed in the Thumbnail view window on the left column of the interface.

6. If necessary, adjust and optimize image by using the **Image Adjustment** controls.
  - a) Select a scanned image to be optimized from the Thumbnail view window.
 

When done, the selected image will be displayed in the **Navigation** window and **Index Preview** window.
  - b) If necessary, click an area of the image in the Navigation window to display that area in the Index Preview Area .

- c) Click the **Image Adjustment** tab and to optimize the image by using the provided tools for your needs there.
7. When done, click the **Export** button to save the scanned or/and optimized image.

The scanned or/and optimized image can be saved as a file in your selected folder.

*Note: For more information about ScanWizard Cubi scanning software, see the manual of ScanWizard Cubi in the Microtek ScanWizard Cubi CD/DVD.*

## ScanWizard Cubi (AP) interface

Click to switch to the ScanWizard Cubi (TWAIN) interface. By there, you can specify your scanning settings.

Select and click on a thumbnail image to display it in the both Navigation and Index Preview windows.

Thumbnail view window

Navigation window

Index Preview window

Click it to bring up a dialog box where you can set up file format settings for output image files.

Image Adjustment | Scanner Control

Image Adjustment | Scanner Control

Brightness -100 100

Contrast -100 100

Filters None

Resolution 1 12

RESET

Image Adjustment | Scanner Control

Image Settings

Left All Right

## Cleaning the Glass Surface

To ensure optimal performance for your scanner, it is important to clean the glass surface of the scanner on a regular basis.

First, lift up the upper cover of the scanner. Make sure that it has been lifted up to a proper position for safety. Then, use a soft, non-abrasive and lint-free cloth to gently wipe the glass surface area on the scanner's flatbed.

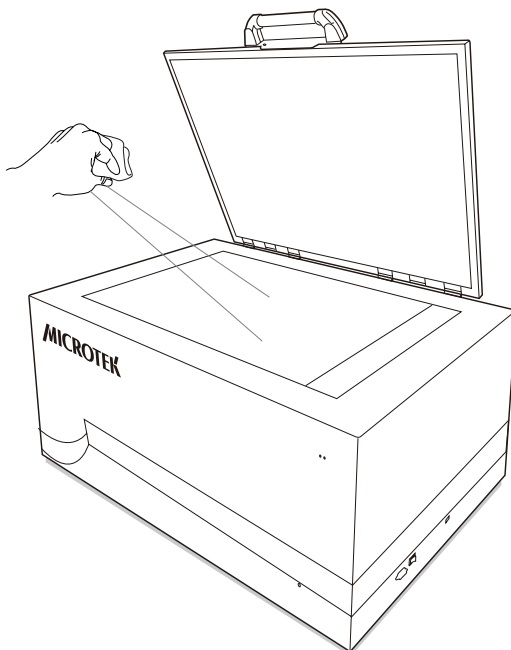

## Maintenance

After usage for a period of time, the parts inside your scanner, such as the light source, may become worn out, and a problem such as insufficient light supply may occur. In this cases, contact your local dealers or wholesales for the maintenance services.



*Note: Your scanner need a professional to perform the required service or maintenance. Do not attend to fix or perform the maintenance by yourself, or it may cause dangers to you or the scanner.*



# Appendix

## Troubleshooting

The LEDs on the front-right panel of the scanner indicate the status of the scanner.

- 
**All On - Ready to scan**  
 Microtek scanning software has been activated and the scanner is found.
- 
**Flashing - Scanning**
- 
**All Off - Scanner is off or Microtek scanning software is not activated.**

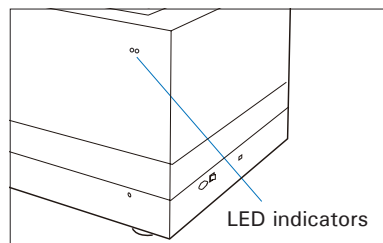

First, make sure that you have followed steps as described in the “Initial Setup” section of this document. Then if your problem is listed here, try the suggested solution.

**1. No light comes on when the scanner is turned on.**

Make sure your scanner is connected to your computer and plugged into a power source.

**2. The Add/Remove Hardware Wizard appears on your screen.**

Click the “Cancel” button and close the Microtek scanning software. Disconnect the Hi-Speed USB cable from your computer, and refer to the installation instructions in this document.

**3. When trying to scan, an error message appears on your screen that reads, “Can’t Find Scanners”.**

Make sure your scanner is unlocked (see “Unlocking the Scanner” in the “Initial Setup” section).

Make sure your scanner is connected to your computer and plugged in to a power source (see “Connecting the Scanner” in the “Initial Setup” section).

Uninstall and reinstall the Microtek scanning software.

**4. After clicking “Scan,” a blank screen appears.**

Make sure your scanner is unlocked (see “Unlocking the Scanner” in the “Initial Setup” section).

Uninstall and reinstall the Microtek scanning software.

**5. Can’t activate the ScanWizard DTG or ScanWizard Cubi scanning software.**

Make sure that the scanning software you have is installed on your computer properly.

Make sure that the supplied USB Dongle come with your scanning software package has been plugged into your computer’s USB port properly.

## Specifications

Model Name	LS-3800
Model Number	MLS-600A1
Image Sensor	CCD
Light Source	LED (Light Emitting Diode)
Scanning Modes	Color and grayscale in a single scanning pass Input: 48-bit color/16-bit grayscale Output: 24-bit color/8-bit grayscale
Resolution	800 dpi
Scanning Area	24" x 37" (610 mm x 940 mm)
Scanning Speed	30 sec @ 200 dpi, A1 color
Interface	Hi-Speed USB (USB 2.0)
Dimensions (L x W x H)	52.4" x 34.3" x 34.7" (1330 mm x 870 mm x 880 mm) (Upper cover is not included)
Weight	379 lbs. (172 kg)
Voltage	AC 100V to 240V, 50/60 Hz 1.7A Max (Input)
Environment	Operating temperature: 50° to 95°F (10° to 35°C) Relative humidity: 20% to 85%
Warranty	Machine: 50,000 scans @ 300 dpi, A1 size or 1 year for normal use  Upper cover: 10,000 times  Glass (Scan bed): Under the warranty period, warranty conditions will not cover the damages caused by natural disaster or inappropriate use.

**Important:** Please never attempt to open or service the machine by yourself; or, this will void your warranty.

Specifications, software bundles, and accessories are subject to change without notice. Not responsible for typographic errors.