



WideTEK® 12

WideTEK® 25



Setup Instructions English

07/2019

Contents

Revision History	5
Information about the Instructions and the Manufacturer	6
Keep Instructions with the Scanner	6
Design Features in Text.....	7
Design Features in Pictures.....	8
Associated Documents	8
Copyright	8
Contact Data of the Manufacturer in Germany.....	9
Technical Support	9
Contact Data of the Manufacturer in the U.S.	9
Safety.....	10
Intended Use	10
Basic Safety Information.....	10
Avoiding Property Damage and Malfunctions.....	12
Responsibility of the Owner	12
Staff Qualifications.....	12
Design Features of Warning Notices	13
Formatting of Information Regarding Property Damage.....	13
Description	14
Purpose and Function	14
WideTEK® 12/25 Overview	14
WideTEK® 12/25 Overview with Backlight (Optional)	15
Rear View of the WideTEK® 12	16
Rear View of the WideTEK® 25	17
User Interfaces.....	18
Setup Menu Overview Screen	19
Rating Plate.....	20

Device Location	22
Environment	22
Prepare for Setup	23
Remove the Transport Locks	23
Connect the Power Supply	24
Establish the Network Connection	25
Connect the Optional Foot Switch	25
Connect the Optional Monitor	26
Connect the Optional Touchscreen	26
Switch On the Scanner	27
Switch Off the Scanner	29
Perform Setup	31
Change the Menu Language	31
Activate the Setup Menu	33
Perform White Balance	37
Perform White Balance with Backlight Cover	45
Assign the IP Address	53
Modify User Settings	61
Set the Time and Date	68
Perform Test Suite	73
Perform Touchscreen Test	77
Recovery	81
Hard Disk / Solid State Disk Software Failure	81
Recover the HD/SSD to Factory Default	82
Preparations to Recover an HD/SSD	82
Recovery Process	82
Recovery Process 2 - Update Scanner Firmware	85
Recovery Process 3 - Adjustments	85
Maintenance	86
Touchscreen	86

Surfaces	86
Cleaning the Glass Plate.....	87
Repair.....	87
Technical Specifications	88
WideTEK® 12 Scanner Specifications.....	88
WideTEK® 25 Scanner Specifications.....	90
Ambient Conditions	91
Electrical Specifications	91
Dimensions and Weight WideTEK® 12	93
Dimensions and Weight WideTEK® 25	93

Revision History

Date	Rev.	Name	Description of Change	Reason of Change
16.10.2017	1.0	JKN	First draft	First published version
23.07.2019	1.1	JKN	Second draft	New power button, optional backlight

Information about the Instructions and the Manufacturer

These instructions show you how to safely prepare and perform the setup for the flatbed scanners WideTEK® 12 and WideTEK® 25. The flatbed scanners WideTEK® 12 and WideTEK® 25 are hereinafter referred to as "Scanner".

In these instructions, the start button is called "power button".

Keep Instructions with the Scanner

These instructions are a part of the scanner.

- Please always store these instructions together with the scanner.
- Ensure that the instructions are available for the user.
- Enclose the instructions when you sell the scanner or transfer it in any other way.

Design Features in Text

Many text passages in these instructions have been formatted to indicate specific elements, as illustrated below:

Normal text

BUTTONS OF THE SCREEN PAGE

"Menu names"

➤ Action steps

• Enumeration of the first level

Cross-references

 Tips contain additional information, such as special information to prepare for and perform the setup.

Design Features in Pictures

Where a reference is made to elements in a legend or in the text, these are marked with a number (1).

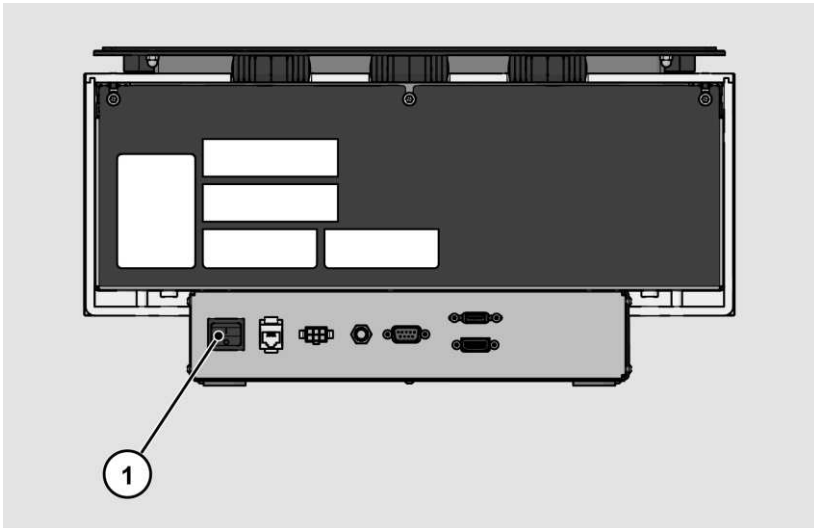

Associated Documents

In addition to these instructions, other documents associated with the operation of the scanner include:

- Unpacking and Repacking Instructions
- Legal Information (Declarations of Conformity, FCC Declaration, Safety & EMI Certificates, RoHS etc.).

Copyright

These instructions contains information that is subject to copyright. These instructions may not be reproduced in any form, printed, filmed, edited, copied or distributed, in whole or in part, without prior written permission from Image Access GmbH.

© Image Access GmbH 2019
All rights reserved.

Trademarks

Scan2Net®, Scan2PAD®, Bookey® and WideTEK® are registered trademarks of Image Access, all other trademarks are the property of their respective owners.

Contact Data of the Manufacturer in Germany

Image Access GmbH
Hatzfelderstraße 161-163
42281 Wuppertal
Phone: +49-202-27058-0
E-Mail: documentation@imageaccess.de
Internet address: www.imageaccess.de

Technical Support

Image Access technical support can be reached at the e-mail address:
support@imageaccess.de.

Contact Data of the Manufacturer in the U.S.

Image Access LP
2511 Technology Drive, Suite 109
Elgin
IL 60124
Phone: +1-224-293-2585
E-Mail: support@imageaccess.us
Internet address: www.imageaccess.us

Safety

Intended Use

The scanner is used for scanning images and documents. It is designed for use in enclosed spaces in the commercial sector.

Intended use also includes observing and following all information provided in these instructions, especially the safety instructions. Any other use is considered to be improper and will void the warranty and liability claims.

Ambient Conditions

Ensure that the scanner is used exclusively under the following environmental conditions:

- Ambient temperature during operation: +5 °C to +40 °C
 - Storage temperature: 0 °C to +60 °C
 - Relative humidity: 20 to 80%, non-condensing
- Ensure that the scanner is not exposed to direct sunlight.

Basic Safety Information

Avoid Injury or Death by Electric Shock

- Never open the housing of the scanner.
- Do not expose the scanner to dripping or splashing water and do not place any vessel filled with liquid on the scanner. Penetrating liquid can damage the scanner.
- Do not insert objects through existing slots or openings into the interior of the scanner.
- Only connect the scanner with the plug of the supplied AC adapter to a professionally installed and grounded outlet.
- Do not use the AC adapter if the power supply's housing or the cable are damaged. In this case, replace the power supply with a power supply of the same type.
- Do not use the scanner if it is visibly damaged. In this case, unplug the power cord from the wall outlet. Contact Image Access technical support, see section *Technical Support* starting at page 9.

Avoid Burns

- Do not cover the existing openings in the scanner housing. They serve to ventilate. Covering the openings could cause overheating.
- Do not place the scanner in front of air conditioning units, which produce high heat.

Avoid Cuts

The glass plate on the scanner is only suitable for the weight of documents. Objects or body parts with higher weights can destroy the glass plate and cause cuts.

- Ensure that the weight of the original to be scanned does not exceed 10 kg / 22 lb.

Avoid Fractures, Contusions and Bruises

Incorrect installation of the cables can cause tripping.

- Lay the connecting cables so that no one can trip over them.

The scanner weighs between 28 and 44 kg, depending on the model.

- Only carry the scanner with a second person.
- Place the scanner only on a stable, level and vibration-free surface that has sufficient strength for the weight of the scanner.

Avoiding Property Damage and Malfunctions

- Ensure adequate ventilation to comply with the environmental conditions.
- Prior to initial installation, remove the mounted transport locks.
- Install the transport locks before transporting the scanner to a new location.
- Do not place the scanner in the vicinity of devices that emit strong electromagnetic radiation.
- Do not use any cleaning agents containing abrasive additives, solvents or acids. Use a damp microfiber cloth.
- Operate the touchscreen only with your finger. Other objects can damage the touchscreen.

Responsibility of the Owner



The scanner owner must ensure that only qualified personnel carry out the setup of the scanner.

Staff Qualifications



The staff that carries out the setup of the scanner must have knowledge in installing, connecting and putting computer accessories into operation.

Design Features of Warning Notices

In these instructions, the following warning information can be found:

⚠ WARNING	
	Notices with the word WARNING warn about a dangerous situation that could lead to death or serious injuries.
⚠ CAUTION	
	Notices with the word CAUTION warn about a situation that could lead to light or medium-scale injuries.

The following symbols are used in the warnings:

Symbol	Explanation
	Danger from electrical shock
	General danger symbol

Formatting of Information Regarding Property Damage

ATTENTION!	
	These notices warn of situations that can lead to property damage.

Description

Purpose and Function

The scanner is used for scanning images and documents. It is designed for use in enclosed spaces in the commercial sector.

WideTEK® 12/25 Overview

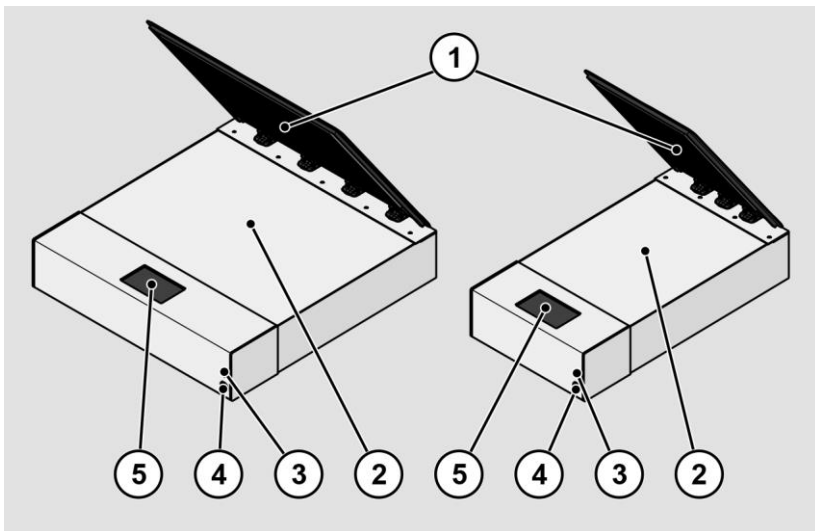

No.	Name
1	Cover
2	Glass plate
3	Power button
4	USB connector
5	Touchscreen

WideTEK® 12/25 Overview with Backlight (Optional)

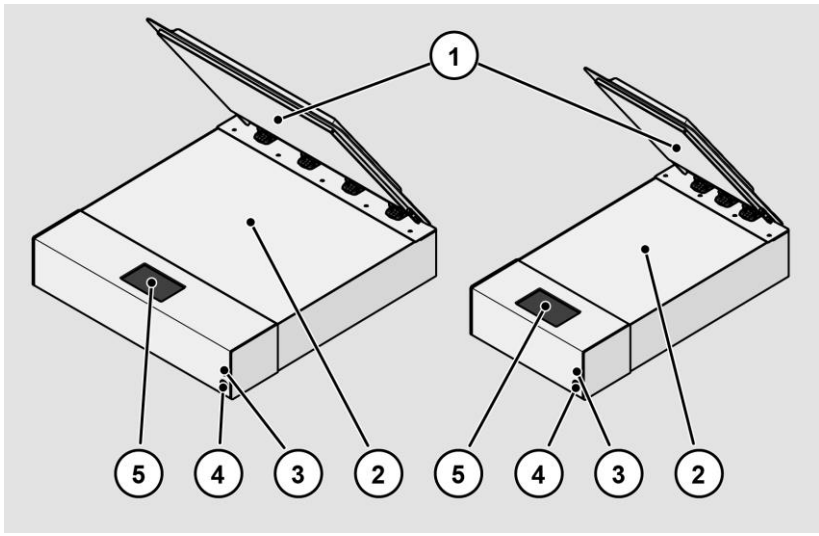

No.	Name
1	Backlight
2	Glass plate
3	Power button
4	USB connector
5	Touchscreen

Rear View of the WideTEK® 12

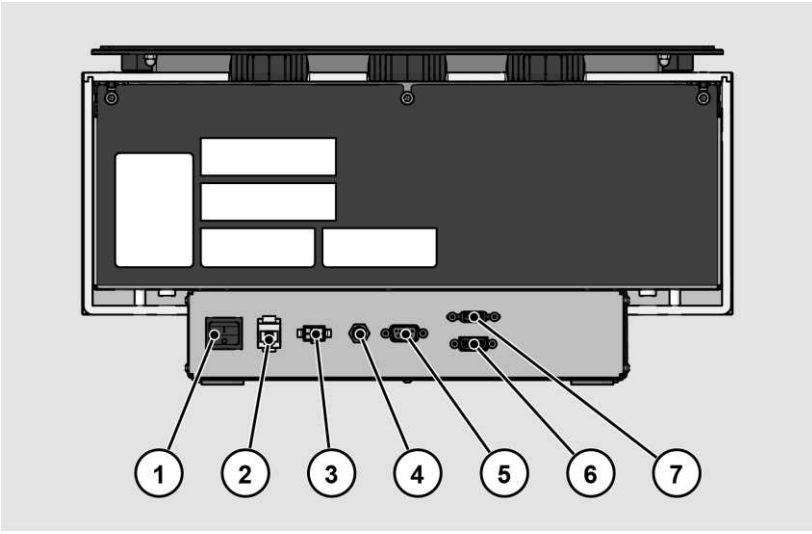

No.	Name
1	Main switch
2	Network connector
3	24 Vdc connector for external power supply
4	Foot switch connector
5	Recovery key connector
6	HDMI connector
7	USB connector

Rear View of the WideTEK® 25

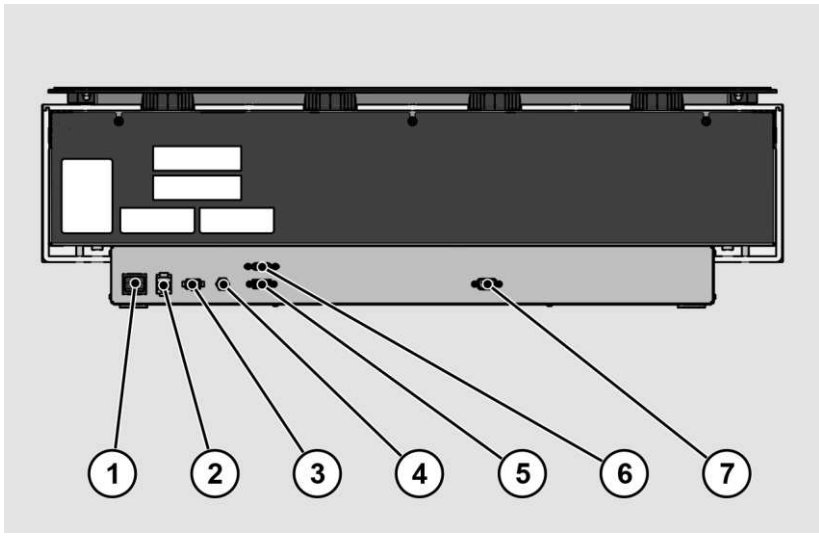

No.	Name
1	Main switch
2	Network connector
3	24 Vdc connector for external power supply
4	Foot switch connector
5	HDMI connector
6	USB connector
7	Recovery key connector

User Interfaces

The scanner can be operated in four ways.

- Via the integrated small touch screen and the ScanWizard App user interface.
- Via the externally connected former preview monitor, as touch screen for the ScanWizard Touch user interface.
- Via a standard web browser and the ScanWizard Client user interface.
- Via the Batch Scan Wizard scan application connected over a network PC.

Setup Menu Overview Screen

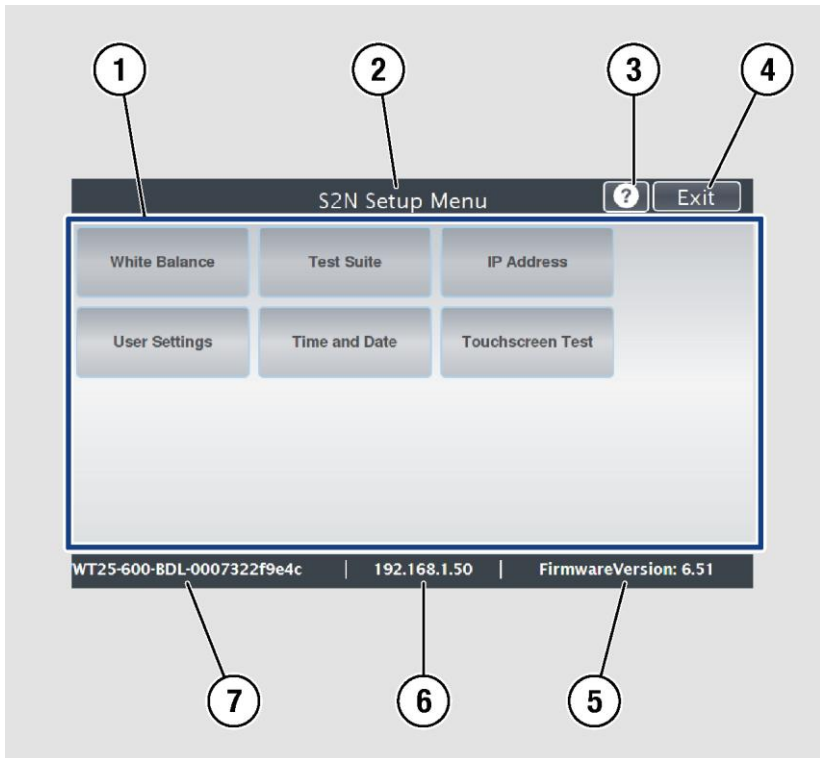

No.	Name
1	Buttons and parameters
2	Menu name
3	Display the online help ¹
4	Button to leave the setup menu to the start screen
5	Firmware version
6	IP address
7	Serial number

¹ The display of the online help is only available when a second touchscreen is connected to the scanner.

Description

Rating Plate

The rating plate is attached to the back of the scanner.

The following figure shows the WideTEK® 12 rating plate.



Self Declaration: Conforms to IS 13252 (Part 1):2010, R-41006380

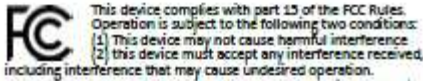

Serial #/Manufacturing Date on Barcode Label

The following figure shows the WideTEK® 25 rating plate.

Type/品类: Flatbed Scanner/平板扫描仪
 Model/型号: WT25-650
 Volt/电压: 24V  Amperes/电流: 5A



 Conforms to UL Std.
 60950-1 and 62368-1
 Cert. to CSA Std. C22.2
 No. 60950-1 and 62368-1
 Intertek

 Intertek
 3171507

Self Declaration: Conforms to IS 13252 (Part 1)-2010, R-41098236

 This device complies with part 15 of the FCC Rules.
 Operation is subject to the following two conditions:
 (1) This device may not cause harmful interference.
 (2) this device must accept any interference received,
 including interference that may cause undesired operation.







 Made in Germany 德国制造
 Image Access GmbH, Wuppertal
www.imageaccess.de

Serial #/Manufacturing Date on Barcode Label

Device Location

Environment

Choose a location that complies with the temperature and humidity specifications.

Please allow

- a minimum distance of 150 mm (6 inches) from any side walls,
- a minimum distance of 300 mm (12 inches) from a back wall,
- a minimum distance of one meter (3 feet) from any door or entrance way.

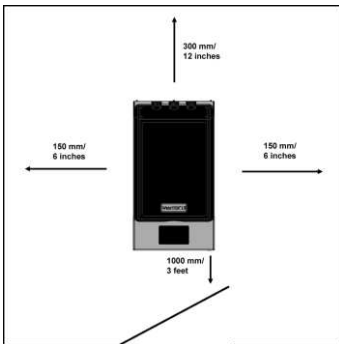

Place the WideTEK® 12 or WideTEK® 25 scanner on a flat and solid base. The load bearing capacity of the base must correspond to the device weight. The dimensions of the base must match the floor space required by the scanner.

- ⓘ Before using the scanner in the new environment allow at least one hour for temperature adaptation.

A fast change from cold to warm environmental conditions can build up condensation inside the housing.

This will result in unfavorable scanned images and could cause permanent damages to the unit.

Prepare for Setup

Remove the Transport Locks

The scanner is equipped with two transport locks. Transport locks are located on the bottom left and right. They can be identified by the plastic tab (1).

The following figure shows the WideTEK® 12 model.

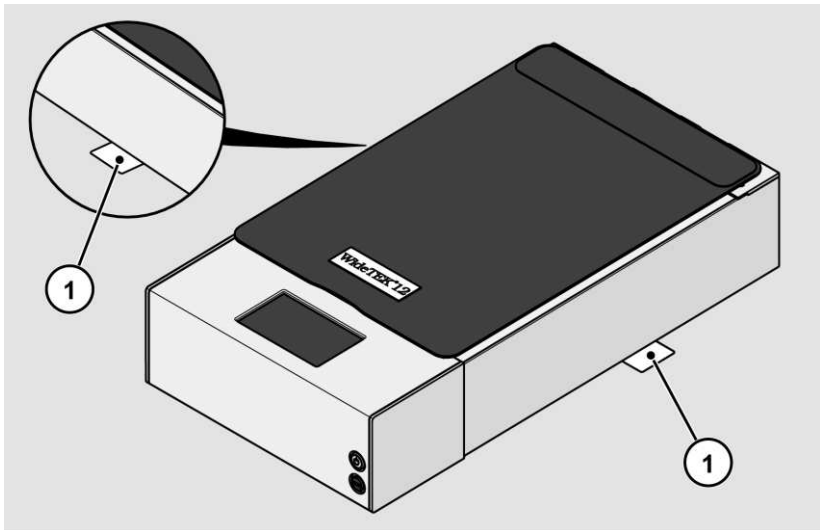

You must remove the transport locks before using the scanner for the first time. To remove the transport locks, proceed as follows:

- Screw the two transport locks counterclockwise completely out of the scanner.
- Keep the transport locks for future use.

Connect the Power Supply

WARNING



Risk of electric shock due to incorrect connection.

- Ensure that the power receptacle intended for the connection is properly grounded.
- Ensure that the power receptacle intended for the connection of the scanner is properly fused.

CAUTION



Incorrect laying of the connection cables can cause tripping. Fractures, contusions and bruises can be the result.

- Place the connecting cables so that no one can trip over them.

To connect the power supply, proceed as follows:

- Make sure that the main switch of the scanner is switched off (0 position).
- Use only the AC adapter and power cord supplied.
- Ensure the power cord is not damaged.
- Connect the connector from the power supply to the associated 24 Vdc connector on the back of the scanner.
- If not already done, connect the supplied power cable to the associated connector on the power supply.
- Connect the power plug of the power supply to a power receptacle of the correct voltage (100-240 Vac).

Establish the Network Connection

CAUTION



Incorrect laying of the connection cables can cause tripping. Fractures, contusions and bruises can be the result.

- Place the connecting cables so that no one can trip over them.

To establish the network connection, proceed as follows:

- Connect one plug of the enclosed network cable to the network connector socket on the back of the scanner.
- Connect the second plug to the network socket of an existing network.

Connect the Optional Foot Switch

CAUTION





Incorrect laying of the connection cables can cause tripping. Fractures, contusions and bruises can be the result.

- Place the connecting cables so that no one can trip over them.

- Connect the plug of the foot switch to the connector socket for the foot switch, located on the back of the scanner.



Connect the Optional Monitor

 CAUTION	
	<p>Incorrect laying of the connection cables can cause tripping. Fractures, contusions and bruises can be the result.</p> <ul style="list-style-type: none">➤ Place the connecting cables so that no one can trip over them.

To connect the optional monitor, proceed as follows:

- Connect the HDMI connector plug of the monitor to the HDMI connector socket, located on the back of the scanner.

Connect the Optional Touchscreen

 CAUTION	
	<p>Incorrect laying of the connection cables can cause tripping. Fractures, contusions and bruises can be the result.</p> <ul style="list-style-type: none">➤ Place the connecting cables so that no one can trip over them.

To connect the optional touchscreen, proceed as follows:

- Connect the HDMI connector plug of the touchscreen to the HDMI connector socket, located on the rear of the scanner.
- Connect the USB connector plug of the touchscreen to the USB connector socket, located on the back of the scanner.

Switch On the Scanner

ATTENTION!

- Damage to the scanner can be caused by a transport lock not removed prior to power on.
- Ensure that both transport locks are completely removed from the scanner.

To switch on the scanner, proceed as follows:

- Press the MAIN SWITCH (1) on the back to the "I" position.

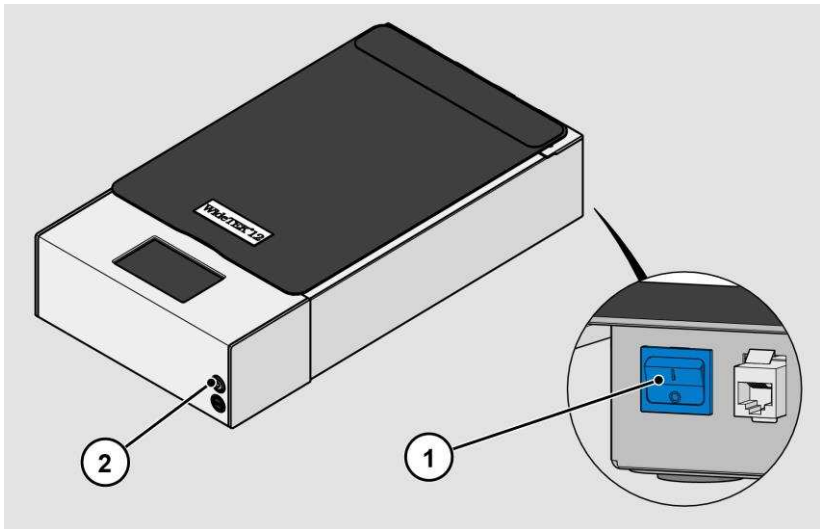

The scanner is in standby mode.

To start the scanner from standby mode, proceed as follows:

➤ Touch the power button (2).

The power button lights up in blue.

The scanner performs a system test.

After a short wait, the "Start screen" is displayed in English.

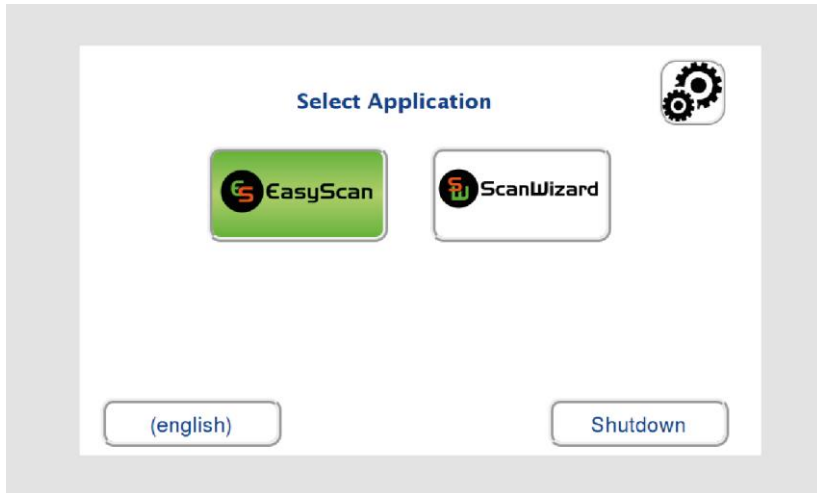

Switch Off the Scanner

To switch the scanner to standby mode after performing the setup, proceed as follows:

- On the "Start screen" screen tap on SHUTDOWN (1).

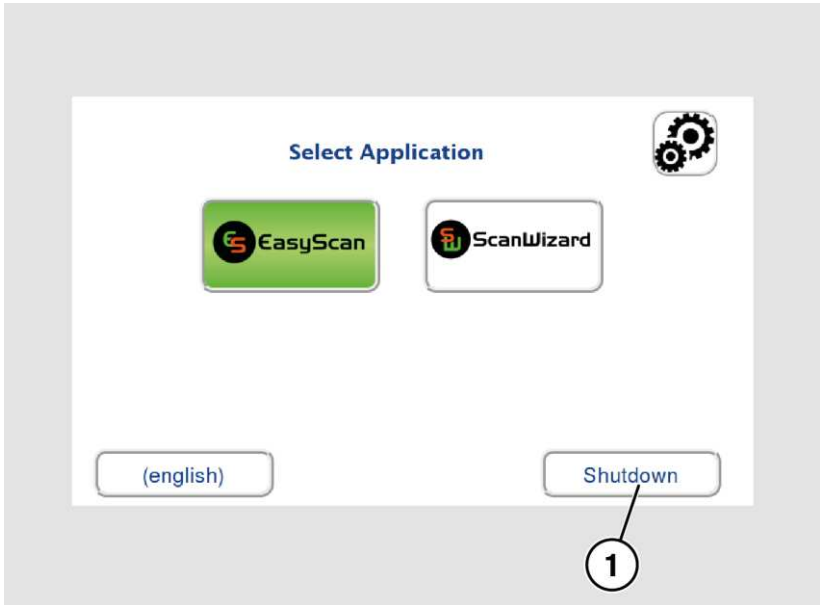

- Confirm with YES.

The scanner shuts down. This process can take up to 40 seconds.

The scanner is in standby mode.

Alternatively, switch the scanner into the standby mode as follows:

- Press the blue illuminated power button (2) and confirm the action in the dialog on the touchscreen.

The scanner shuts down. This process can take up to 40 seconds.

The scanner is in standby mode.

To switch off the scanner for longer periods, proceed as follows:

- Make sure that the scanner is in standby mode.
- Press the MAIN SWITCH (1) in the "0" position.

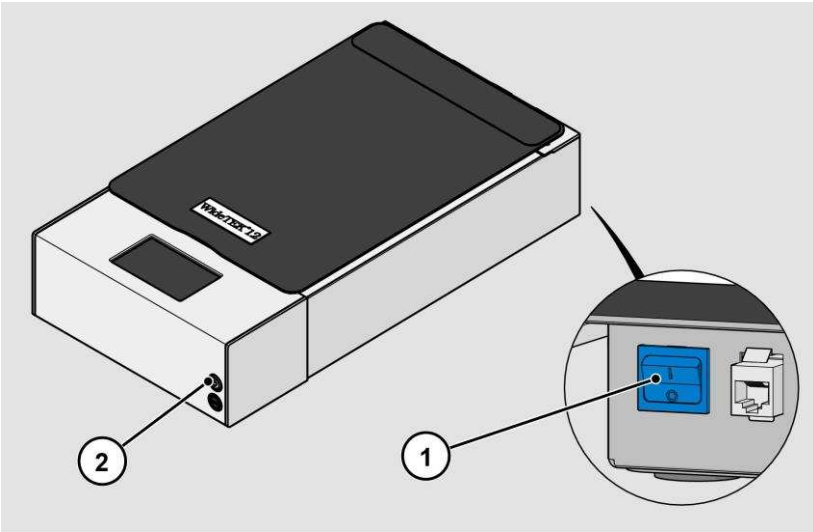

To switch off the scanner using a hard shutdown, proceed as follows:

- Press and hold the power button for longer than four seconds. The power supply to the scanner is immediately interrupted.
- Press the MAIN SWITCH (1) in the "0" position.

Perform Setup

Change the Menu Language

To change the menu language, proceed as follows:

- Tap the LANGUAGE (1) button to see all available languages.

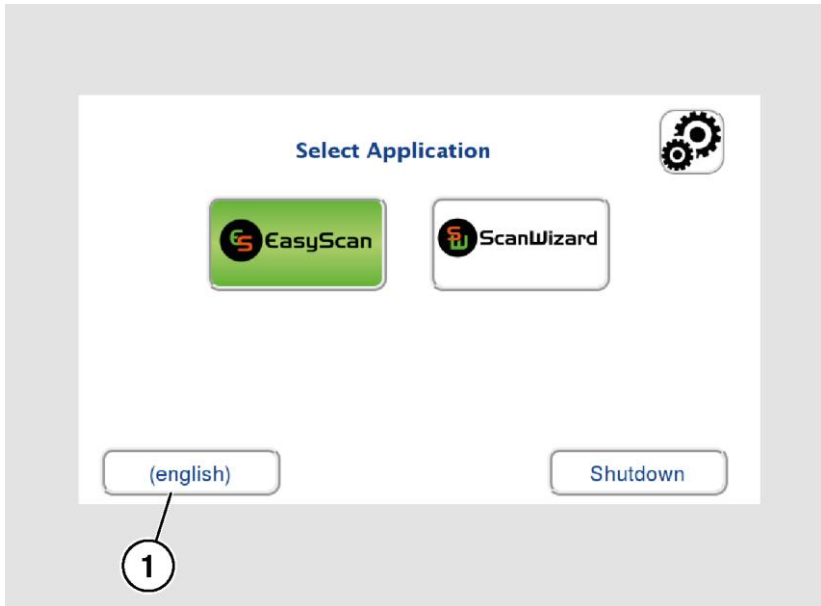

A window for selecting the language appears.

- To display more languages, slide the scroll bar (1) downward.



- Tap the desired language.

The window for selecting the language is closed. The "Start screen" is displayed.

Activate the Setup Menu

To activate the setup menu, you must log in on the scanner. Proceed as follows:

- Tap the GEAR SYMBOL (1).

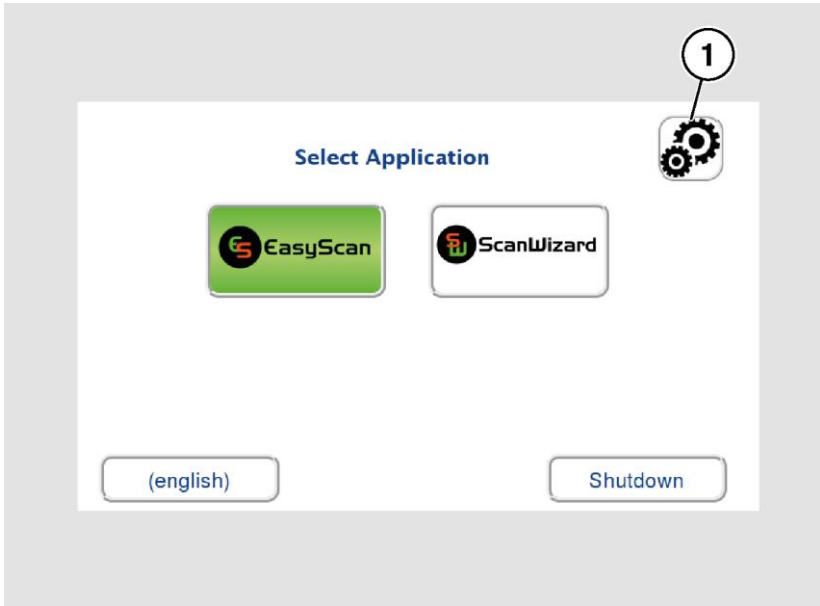

The login window appears.

- In the login window, enter the login credentials.
- Tap on the "Username" input field.

The screen keyboard is displayed.

- Enter the word "Poweruser".
- Tap on the "Password" input field.
- Enter the word "Poweruser".
- Please note that the input is case sensitive in both entry fields.

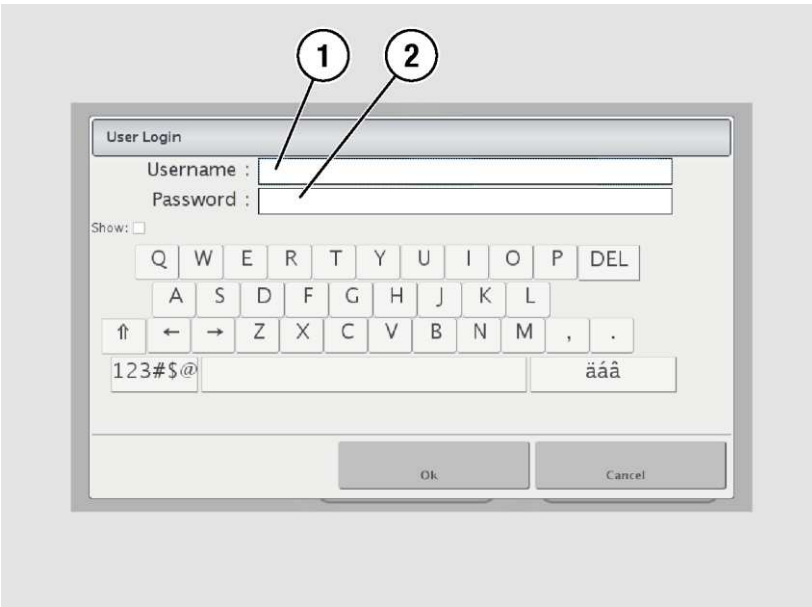

- To complete the log in, press OK (1).

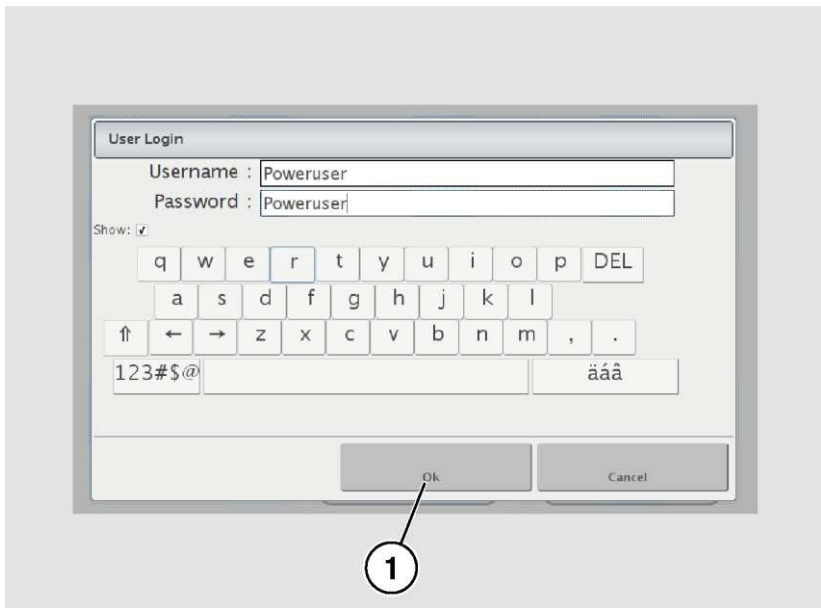

The "Setup Menu" screen is displayed.

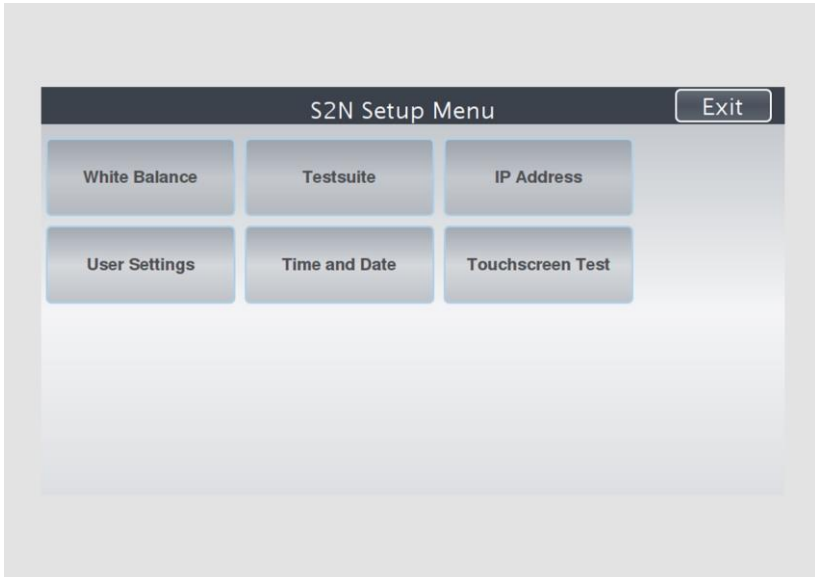

White Balance: Display the "White balance" submenu

Test Suite: Display the "Test Suite" submenu

IP Address: Display the "IP Address" submenu

User Settings: Display the "User Settings" submenu

Time and Date: Display the "Time and Date" submenu

Touchscreen Test: Display the "Touchscreen Test" submenu

- To select a submenu from the "S2N Setup menu" screen, tap with your finger on the button of the screen.

Perform White Balance

- On the "Setup Menu" screen, tap on WHITE BALANCE (1).

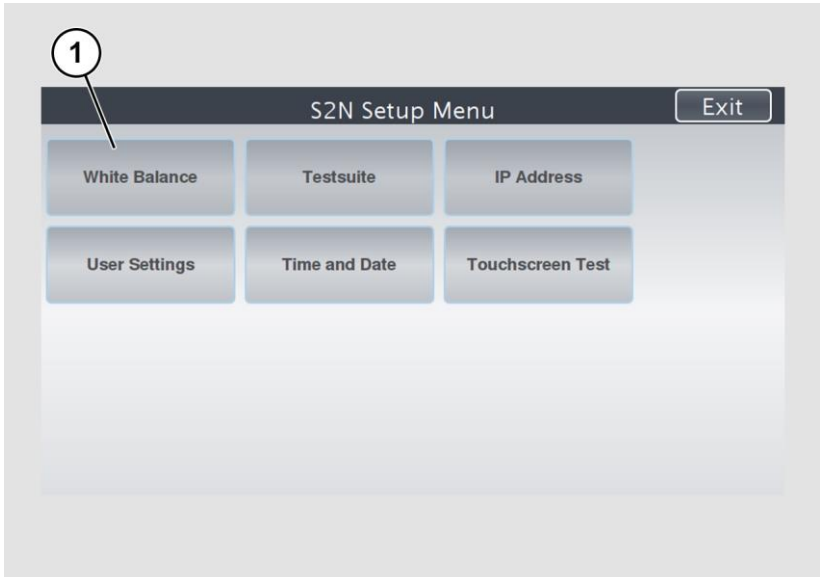

The "White Balance" screen is displayed.

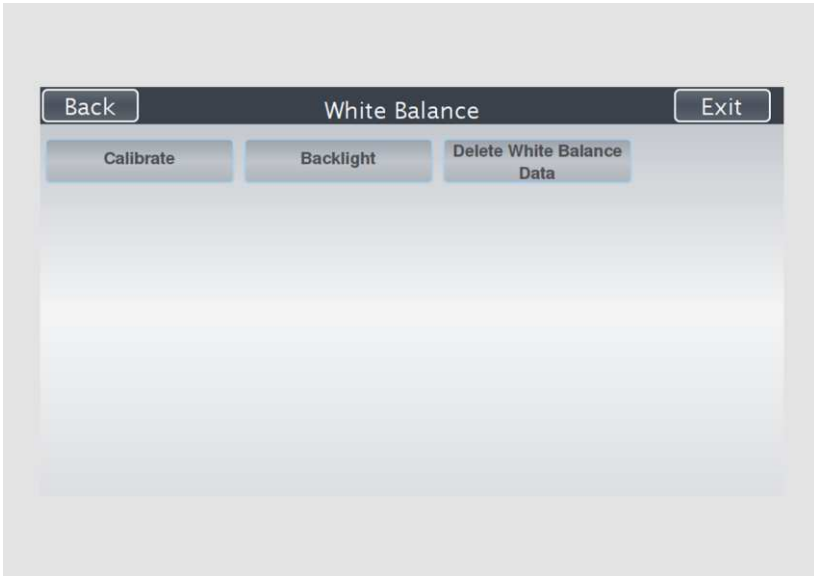

Calibrate:	Start white balance
Backlight:	Start white balance for backlight
Delete White Balance Data:	Delete existing white balance data

The white balance is used to ensure the quality of the scan results. The white balance will be carried out using a test target. The test targets are marked as follows:

- WT12-WA-01-A for WideTEK® 12
- WT25-WA-01-A for WideTEK® 25.

ATTENTION!

Impairment of the scan quality can occur if an improper test target for the white balance is used.

- Make sure that the test target is free from wrinkles, discolorations, cracks or other damage.
- Store the test target for the white balance in a safe place protected from daylight.

To perform the white balance, proceed as follows:

- Open the cover (1) of the scanner.
- Insert the supplied test target (2) with the writing or test strips facing down toward the camera at the top of the glass plate.

The test target (2) covers the entire width of the glass plate.

The following figure shows the model WideTEK® 12.

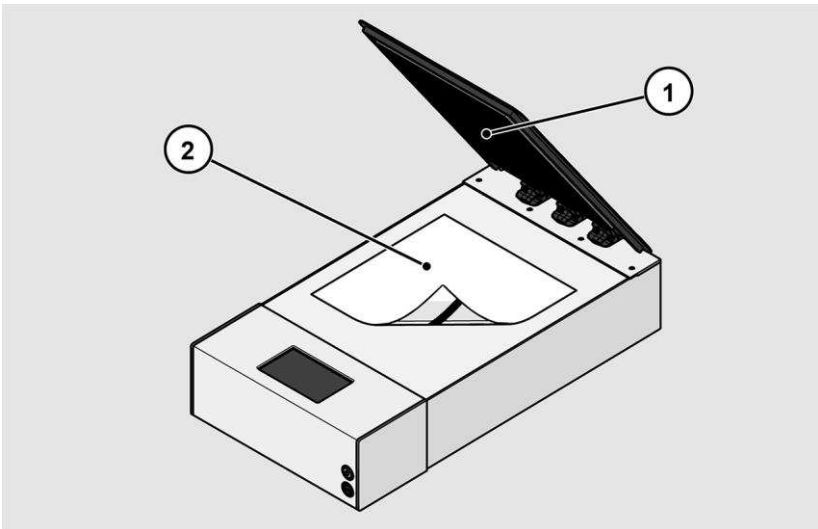

- Close the cover of the scanner.
- Tap on CALIBRATE (1).

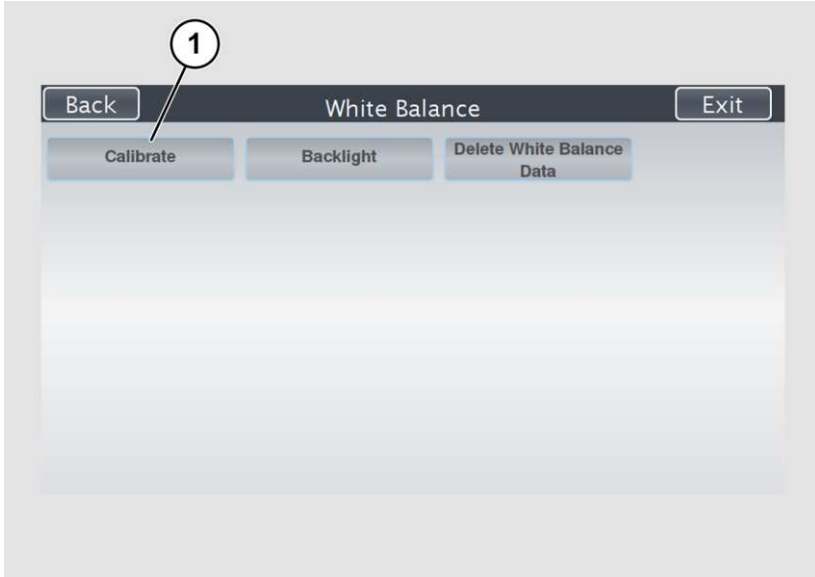

➤ Tap on NEXT STEP (1).

The following figure shows the model WideTEK® 25.

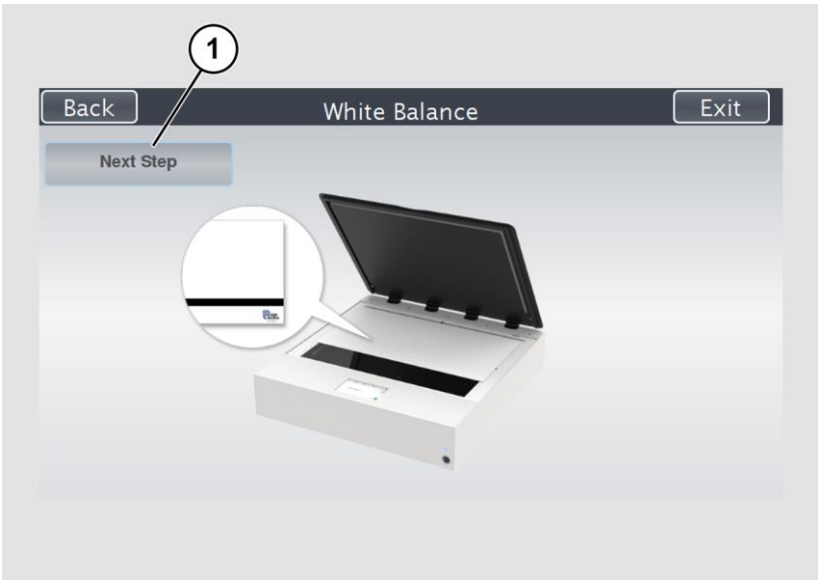

The white balance starts and the calibration is performed. During the white balance, a rotating icon appears. The entire white balance sequence takes about 40 seconds.

Then, the white balance result is displayed as shown on the example below.

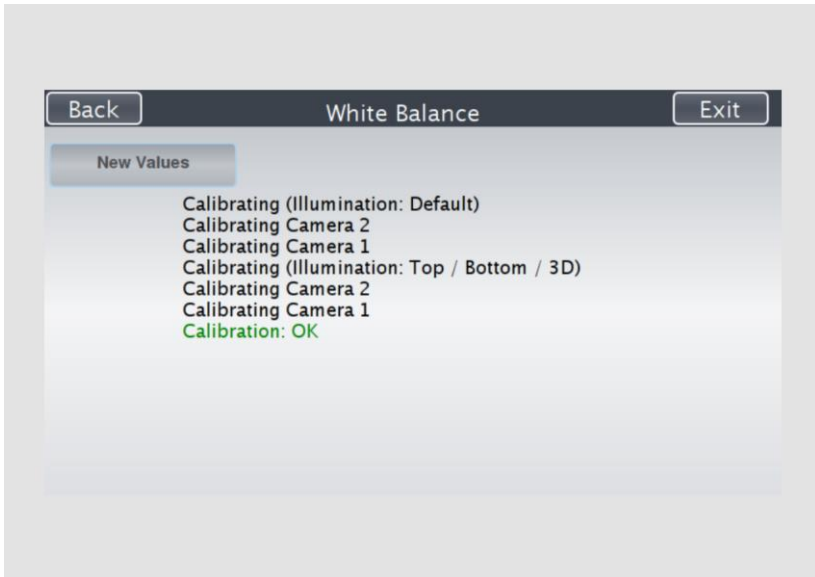

-  On an error-free white balance calibration, the result is displayed in green.
An incorrect result is displayed in red. If this is the case, repeat the white balance calibration again.

- To perform the white balance again, tap NEW VALUES (2).
- To return to the previous submenu, tap BACK (1).
- To return to the "Start screen", tap EXIT (3).

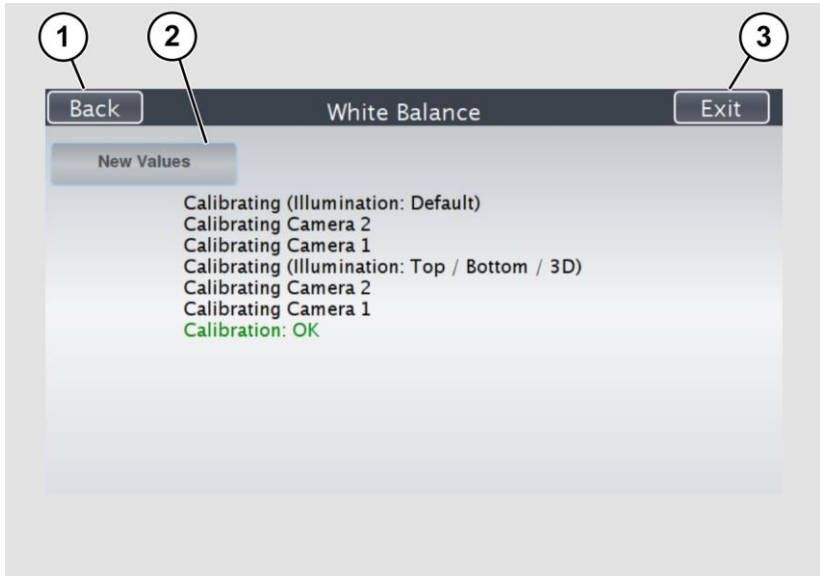

- To delete the stored data of the white balance calibration, tap DELETE WHITE BALANCE DATA (2).
- After deleting the stored data, run the white balance again, as described.
- If problems arise during the white balance calibration, contact Image Access technical support, see section *Technical Support* starting at page 9.
- To return to the previous submenu, tap BACK (1).
- To return to the "Start screen", tap EXIT (3).

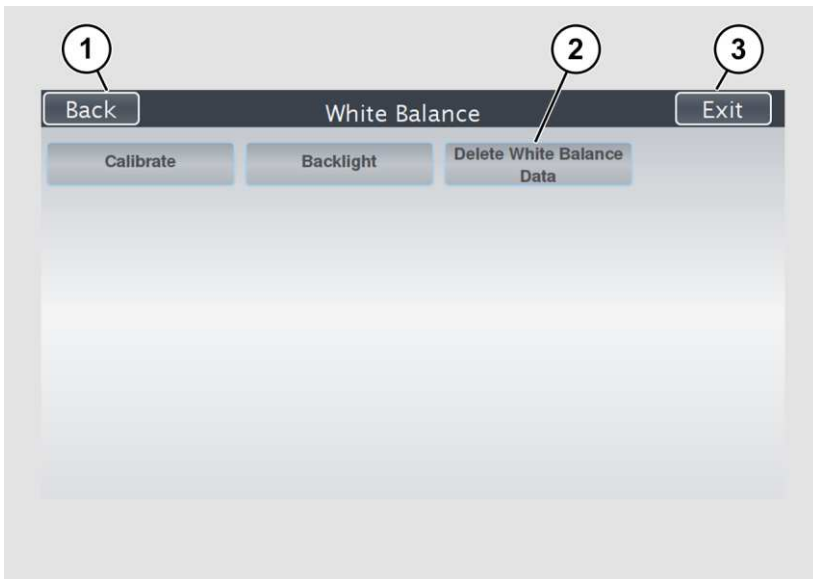

After a successful white balance, proceed as follows:

- Remove the test target.
- Store the test target in a place which is protected from daylight.
- Ensure that the test target is not damaged, bent or soiled.

Perform White Balance with Backlight Cover

- On the "Setup Menu" screen, tap on WHITE BALANCE (1).

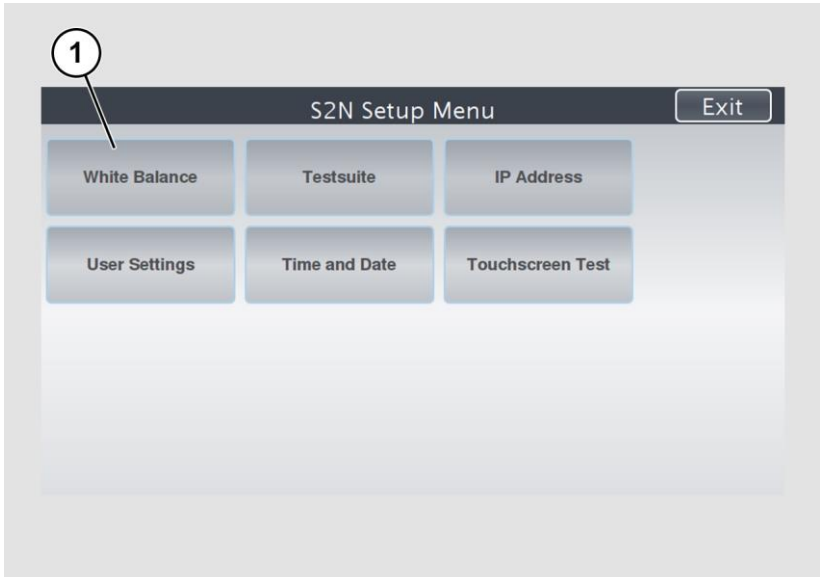

The "White Balance" screen is displayed.

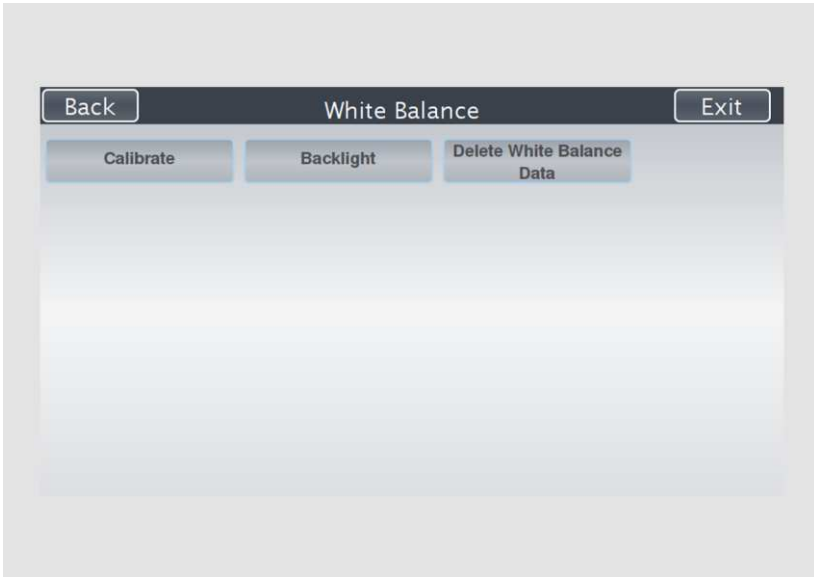

Calibrate:	Start white balance
Backlight:	Start white balance for backlight
Delete White Balance Data:	Delete existing white balance data

The white balance is used to ensure the quality of the scan results.

To perform the white balance, proceed as follows:

- Open the cover (1) of the scanner.
- Remove all sheets from the glass plate.
- Close the cover of the scanner.
- Switch on the backlight.

The following figure shows the models WideTEK® 12 and WideTEK® 25.

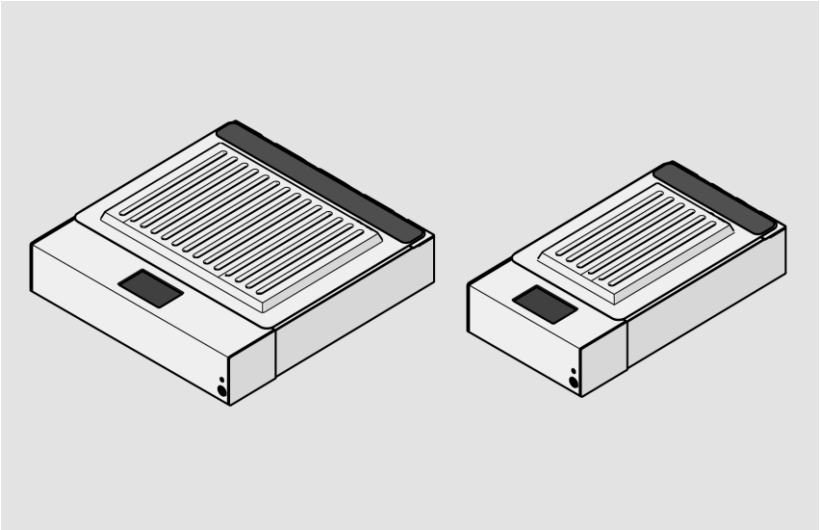

➤ Tap on BACKLIGHT (1).

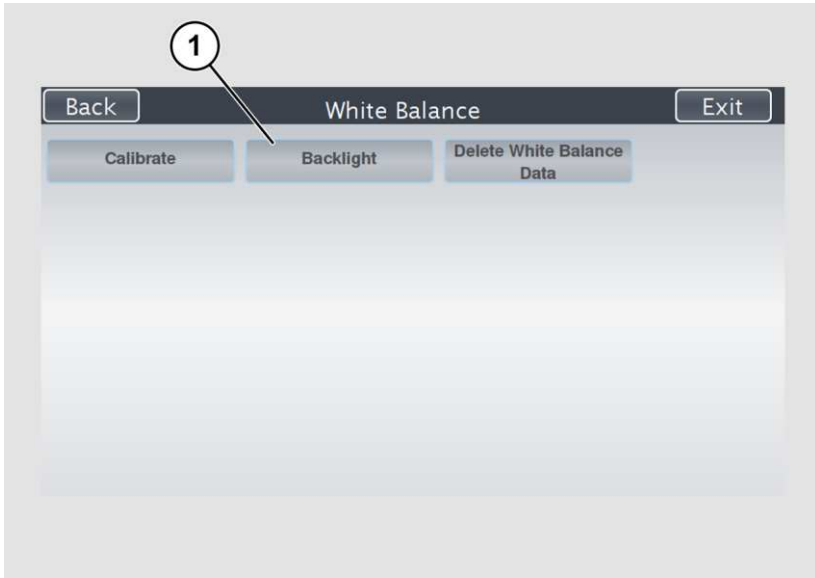

The following figure shows the model WideTEK® 25.

- Tap on NEXT STEP (1).

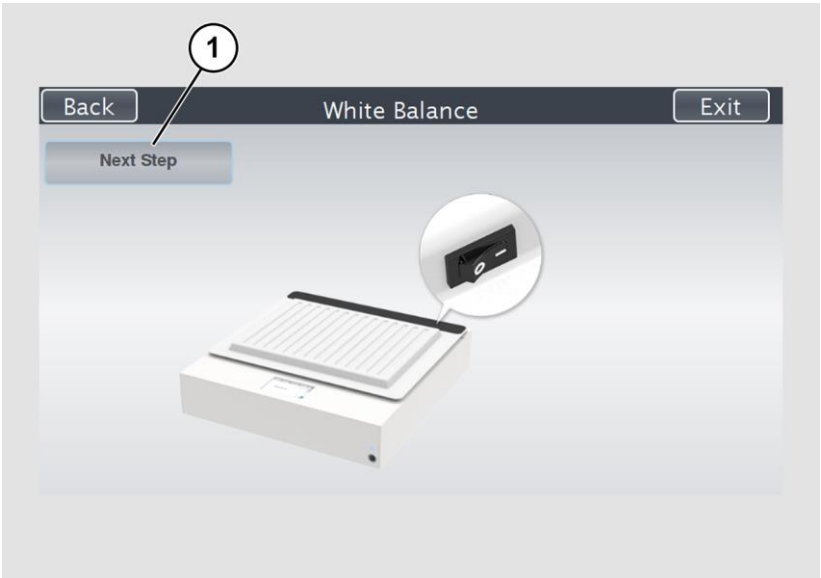

The white balance starts and the calibration is performed. During the white balance, a rotating icon appears. The entire white balance sequence takes about 40 seconds.

Then, the white balance result is displayed as shown on the example below.

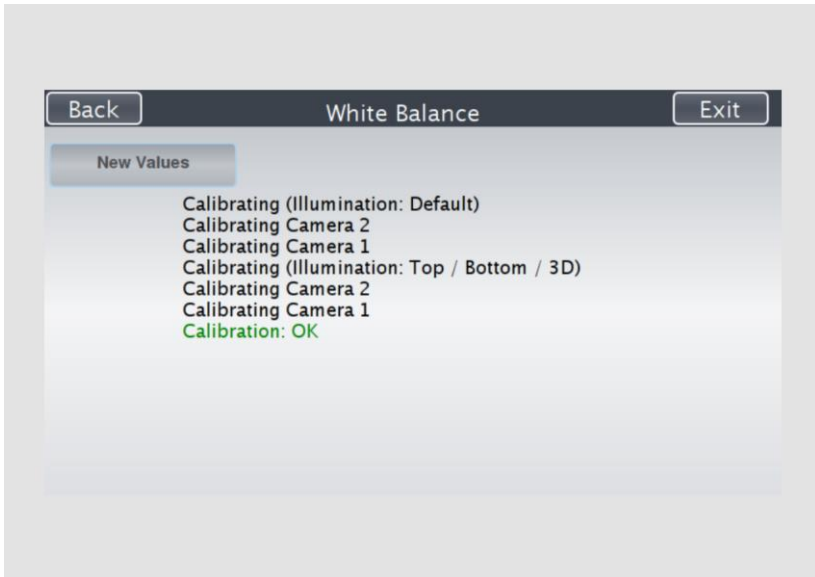

-  On an error-free white balance calibration, the result is displayed in green.
An incorrect result is displayed in red. If this is the case, repeat the white balance calibration again.

- To perform the white balance again, tap NEW VALUES (2).
- To return to the previous submenu, tap BACK (1).
- To return to the "Start screen", tap EXIT (3).

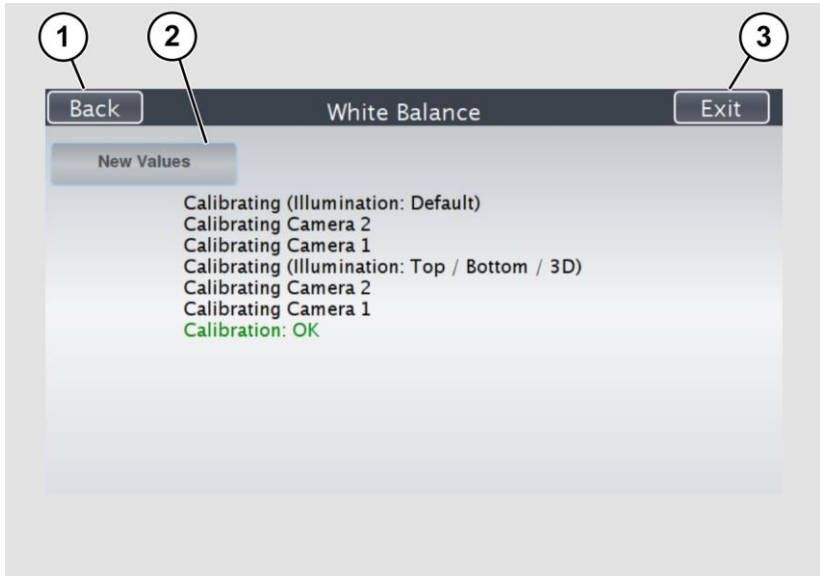

Perform Setup

- To delete the stored data of the white balance calibration, tap DELETE WHITE BALANCE DATA (2).
- After deleting the stored data, run the white balance again, as described.
- If problems arise during the white balance calibration, contact Image Access technical support, see section *Technical Support* starting at page 9.
- To return to the previous submenu, tap BACK (1).
- To return to the "Start screen", tap EXIT (3).

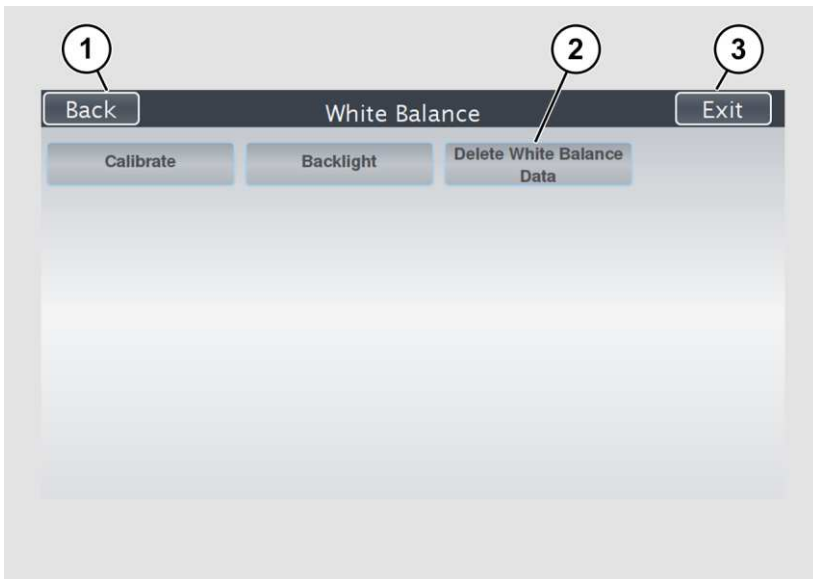

Assign the IP Address

Manually Assign the IP Address

To manually assign the IP address, proceed as follows:

- On the "Setup Menu" screen, tap on IP Address (1).

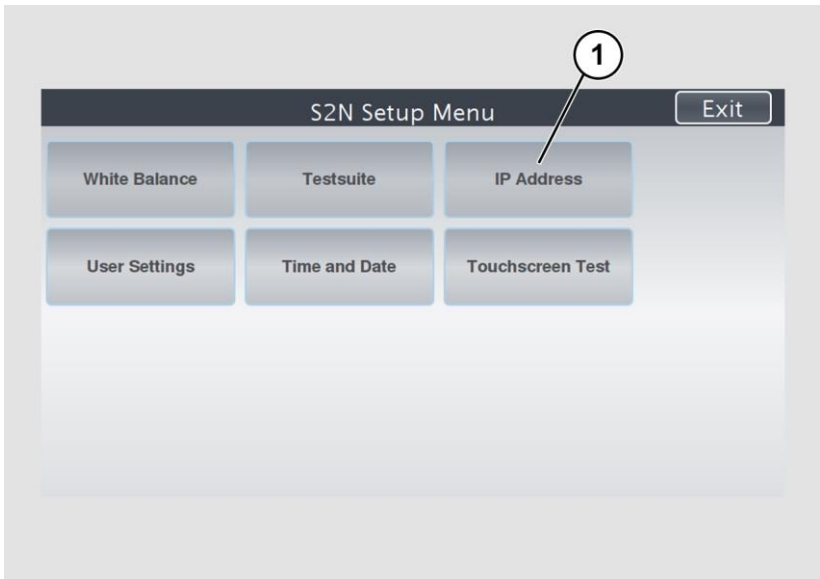

The "IP Address" screen is displayed.

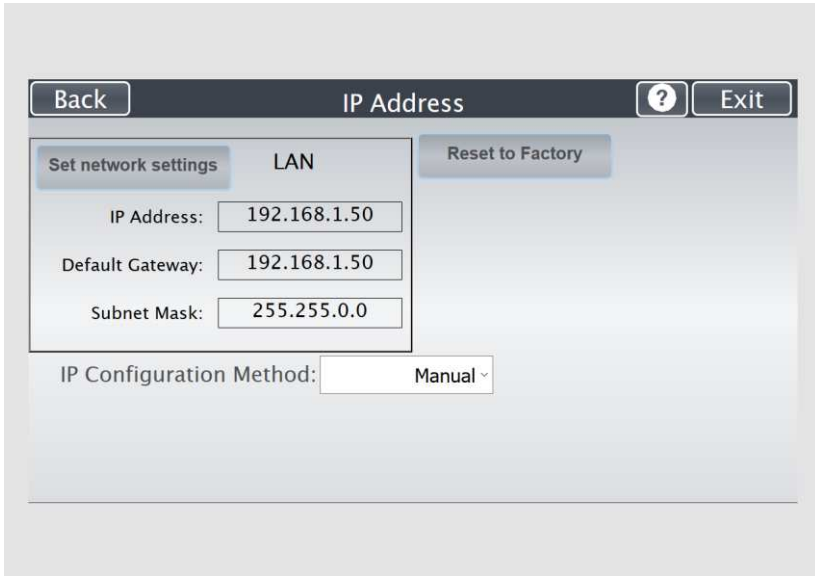

Set network settings:

Accept the network settings provided

Reset to Factory:

Reset to factory settings

IP Address:

Input field for the IP address

Default Gateway:

Input field for the gateway address

Subnet Mask:

Input field for data on the subnet mask

IP Configuration Method

Assign an IP address manually or automatically

Input/DHCP:

- Tap the "IP Address" (1) field.

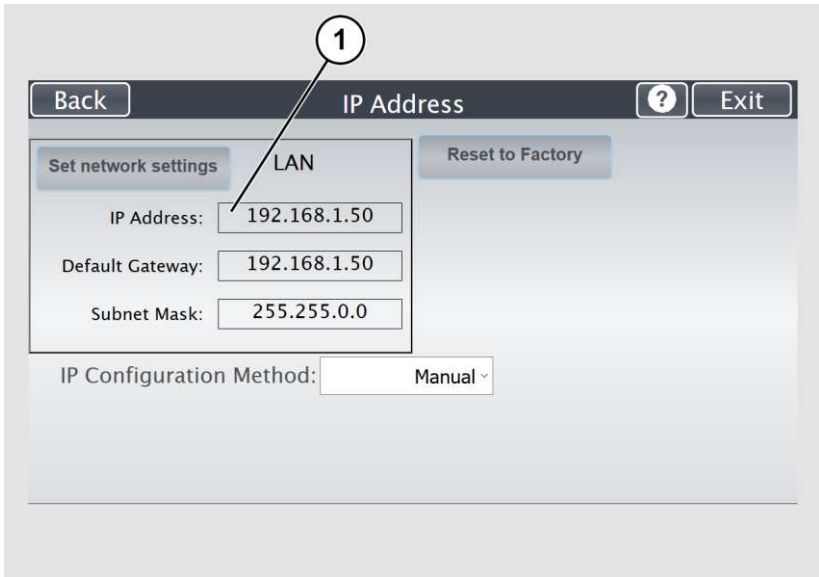

The screenshot displays the "IP Address" configuration screen. At the top, there is a "Back" button on the left, the title "IP Address" in the center, and a help icon (?) and "Exit" button on the right. Below the title bar, there are three main sections: "Set network settings" (a button), "LAN" (the selected network interface), and "Reset to Factory" (a button). Under "Set network settings", there are three input fields: "IP Address:" with the value "192.168.1.50", "Default Gateway:" with the value "192.168.1.50", and "Subnet Mask:" with the value "255.255.0.0". At the bottom, there is a label "IP Configuration Method:" followed by a dropdown menu currently showing "Manual". A circled number "1" is positioned above the IP Address field, with a line pointing to it, indicating the step to tap this field.

The "IP Address" window is displayed.

- Enter the IP address (1).

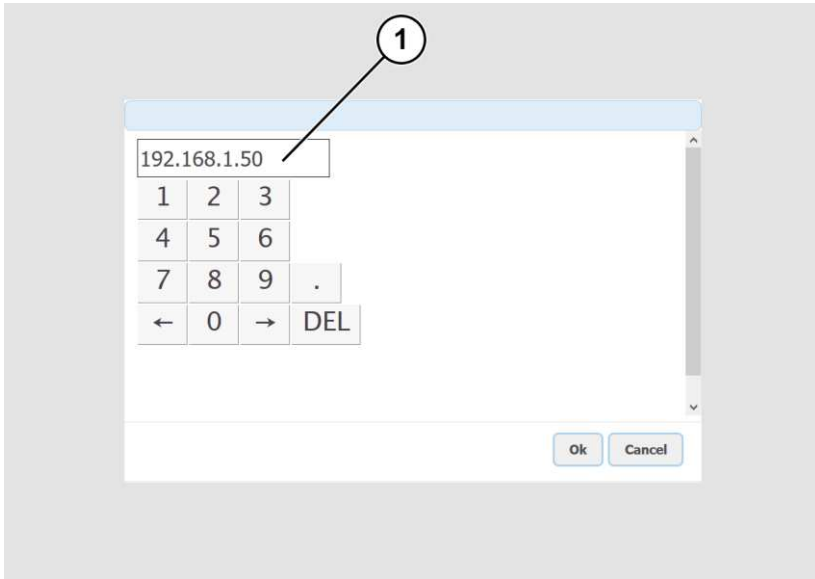

- To delete a digit, move the cursor to the right, behind the digit to be deleted and tap DEL (1).

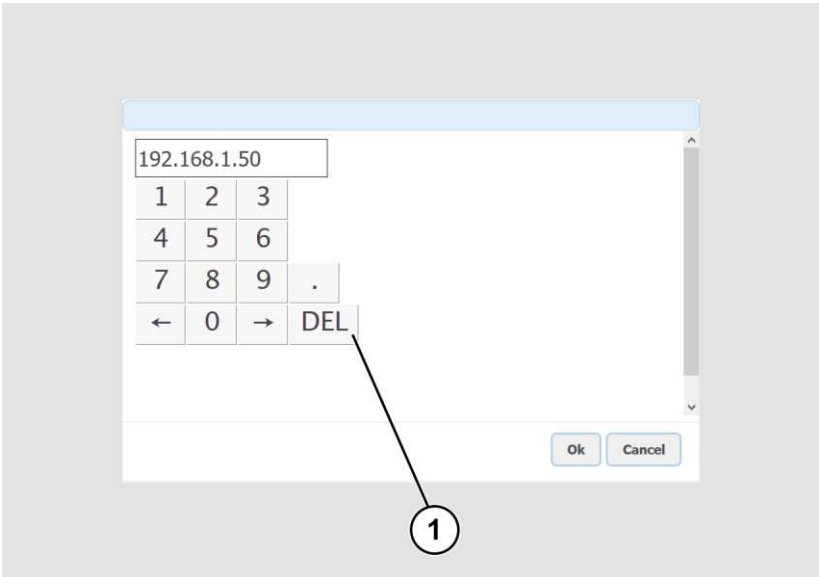

The arrow keys left (1) and right (2) next to the number "0" move the cursor within the chosen row.

- To complete the entry, press OK (3).
- Perform the settings for gateway and subnet mask in the same way.

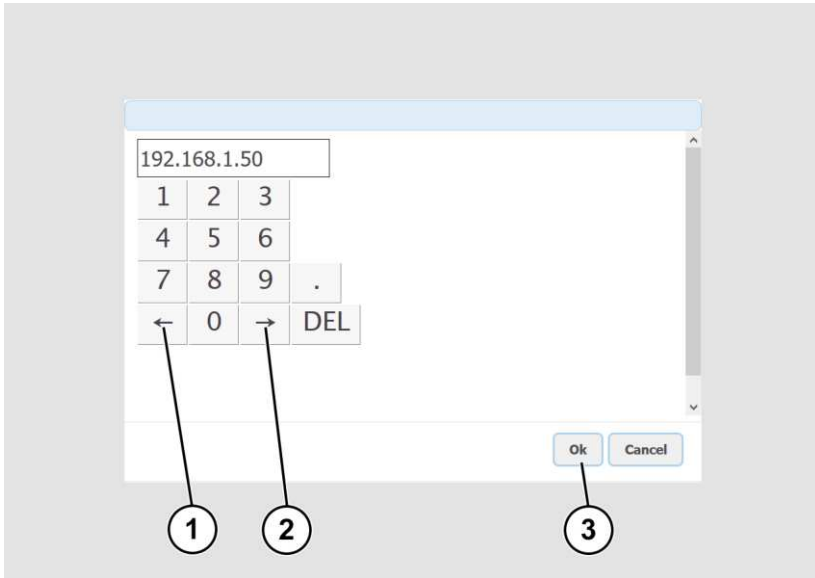

- To save the network settings, tap SET NETWORK SETTINGS (2).
- To return to the previous submenu, tap BACK (1).
- To return to the "Start screen", tap EXIT (3).

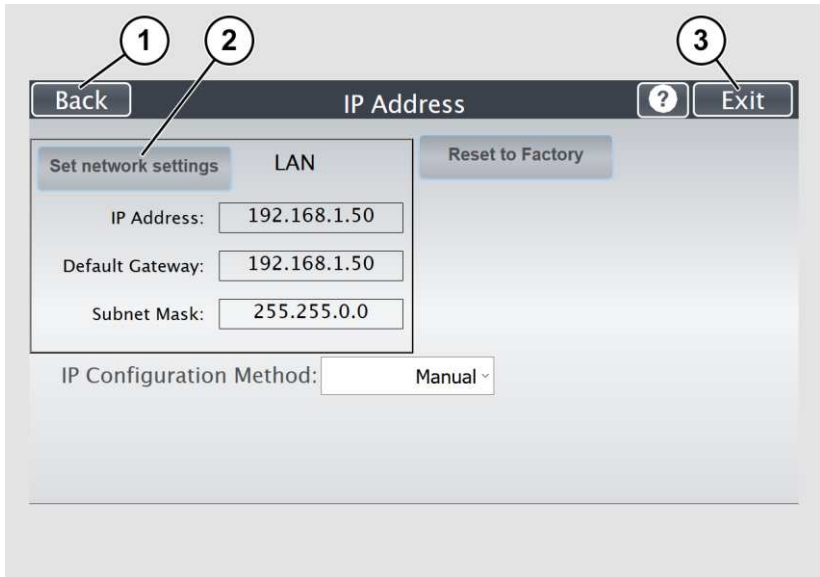

Automatically Assign the IP Address

To automatically assign the IP address, proceed as follows:

- In the selection menu "IP Configuration Method", select the "DHCP" (3) entry.
- To return to the previous submenu, tap BACK (1).
- To return to the "Start screen", tap EXIT (2).

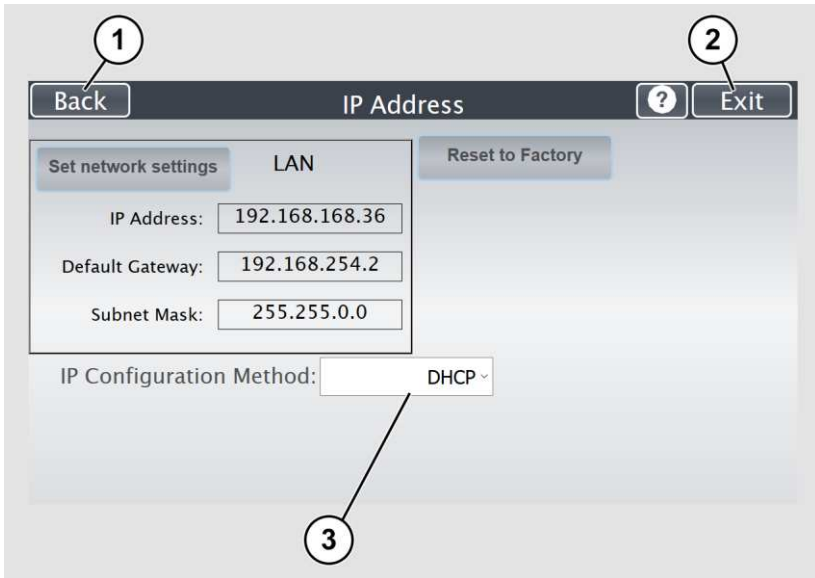

Modify User Settings

- On the "Setup Menu" screen, tap on USER SETTINGS (1).

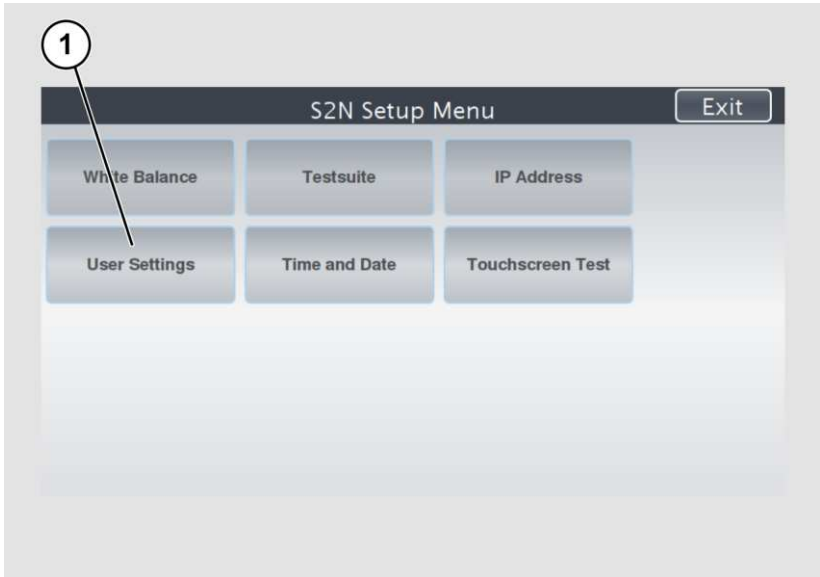

The "User Settings" screen is displayed.

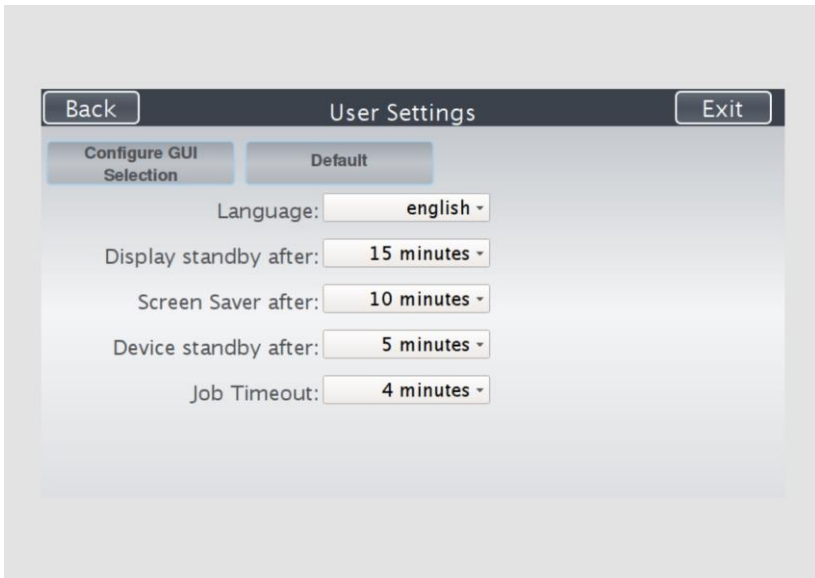

- | | |
|--------------------------|--|
| Configure GUI Selection: | Open the submenu for setting the application in the start screen |
| Default: | The scanner will be reset to the default settings |
| Language: | Select language |
| Display standby after: | Define the period of inactivity, until an optional external monitor and the touchscreen switch to the standby mode |
| Screen Saver after: | The period of inactivity until the screen saver is activated is defined |
| Device standby after: | The period of inactivity until the scanner goes into standby mode is defined |
| Job Timeout | The period of inactivity until the scan job will be terminated is defined. |

Select Language

To select the language, proceed as follows:

- Tap the on the selection arrow of the selection menu "Language" to display the list of languages.
- Tap the desired language (2).
- To return to the previous submenu, tap BACK (1).
- To return to the "Start screen", tap EXIT (3).

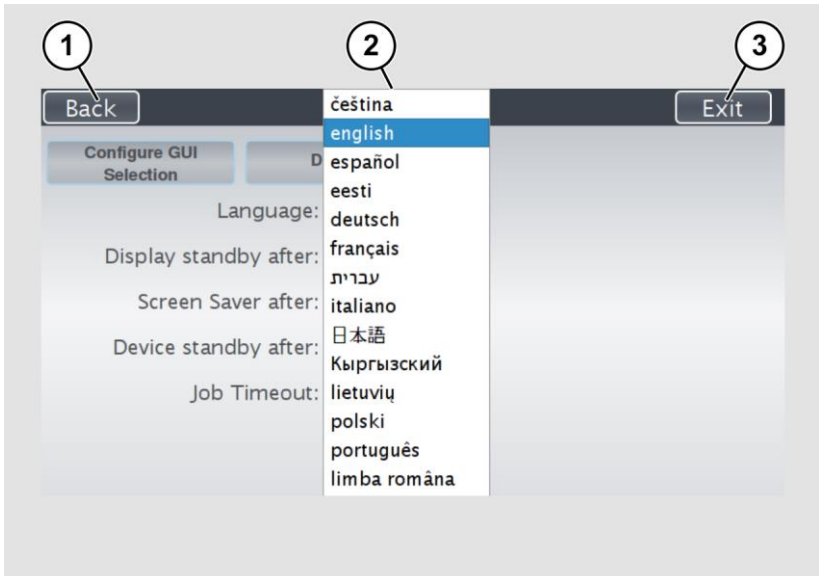

Set Standby Times

To set the standby times, proceed as follows:

- Tap the selection arrow of the selection menu.
- Tap on the desired entry (2).
- Perform the settings for the screen saver and the device standby in the same way.
- To return to the previous submenu, tap BACK (1).
- To return to the "Start screen", tap EXIT (3).

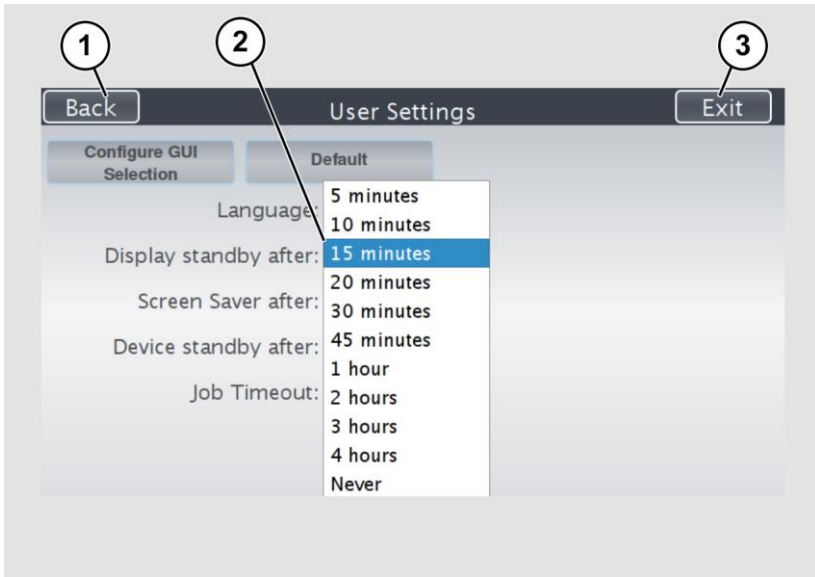

Configuring the GUI Selection

- Tap the "User Settings" screen on CONFIGURE GUI SELECTION (1).

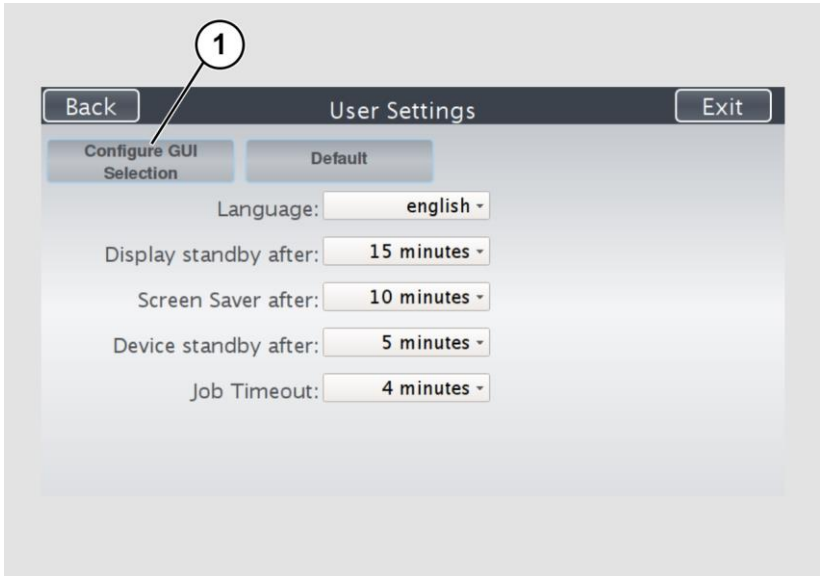

The "Configure GUI Selection" screen is displayed.

This menu displays the "EasyScan" and "ScanWizard" applications, which are available as a standard selection. If, after system start you want to display only one of the applications, proceed as follows:

- Under "Show" (1) disable the box corresponding to the application you do not want to display.

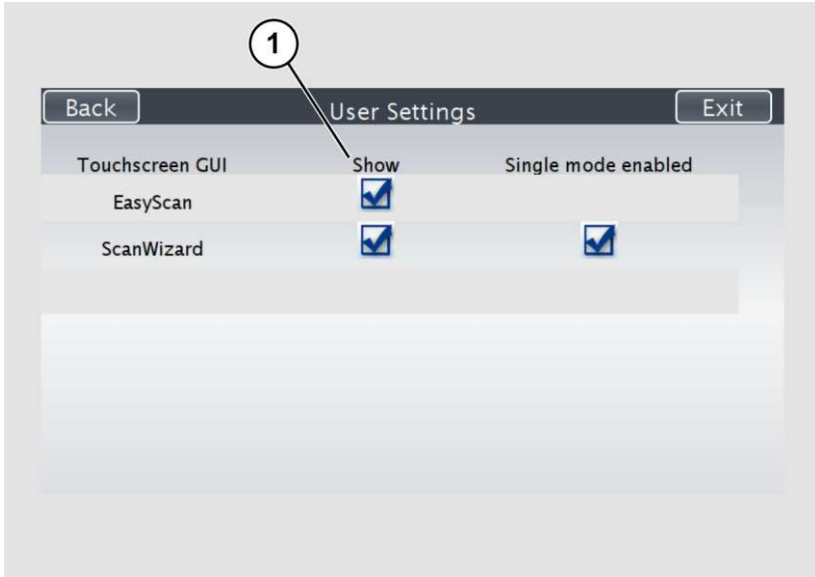

By default, single mode is defined (activate the checkbox "Single mode enabled").

- To start the application in job mode, uncheck the checkbox "Single mode enabled" (2).
- To return to the previous submenu, tap BACK (1).
- To return to the "Start screen", tap EXIT (3).

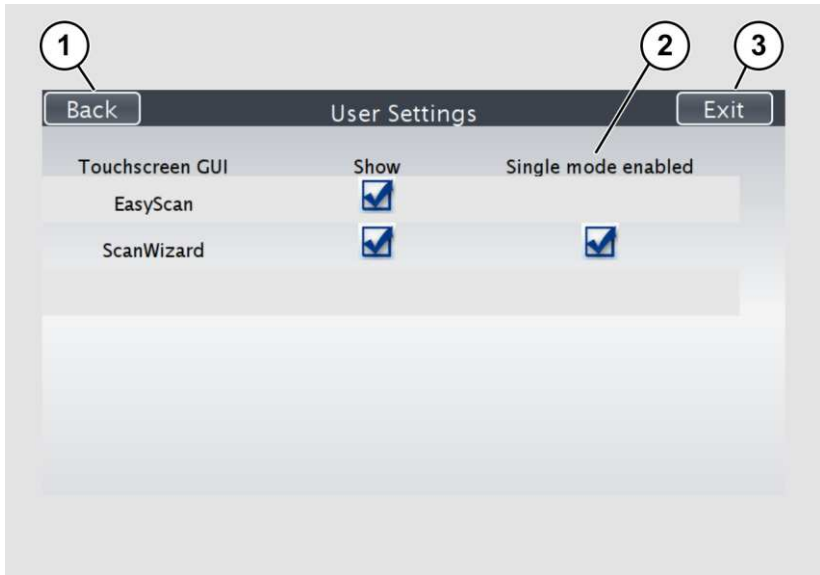

Set the Time and Date

- On the "Setup Menu" screen, tap on TIME and DATE (1).

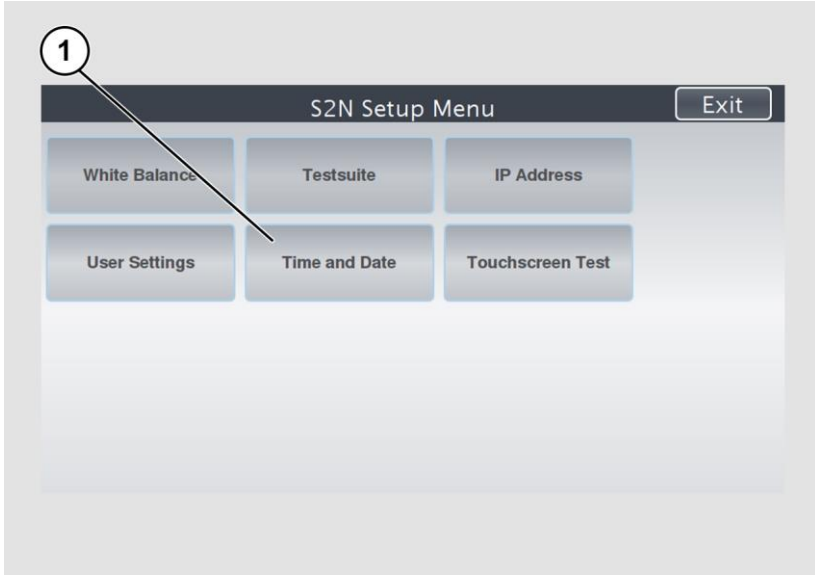

The screen "Time and Date" appears.

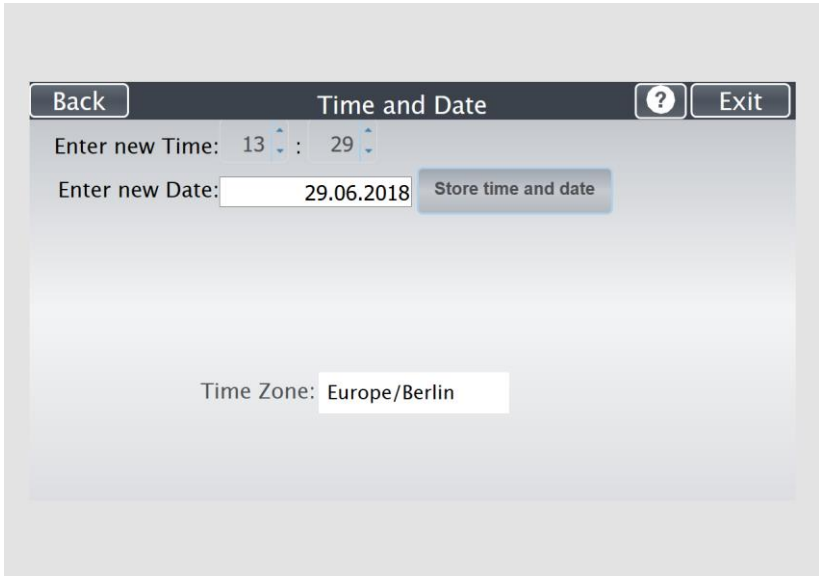

Back Time and Date ? Exit

Enter new Time: 13 : 29

Enter new Date: 29.06.2018 Store time and date

Time Zone: Europe/Berlin

- | | |
|----------------------|---|
| Enter new time: | Enter hours and minutes with the arrow keys |
| Enter new date: | Open a calendar to set the date |
| Store time and date: | Accept the set values |
| Time Zone: | Select a time zone |

To set the time, proceed as follows:

- Tap the "Enter new time" field.
- To set the time later, tap the up arrow (2).
- To set the time earlier, tap the down arrow (2).
- To save the modified time, click STORE TIME AND DATE (3).
- To return to the previous submenu, tap BACK (1).
- To return to the "Start screen", tap EXIT (4).

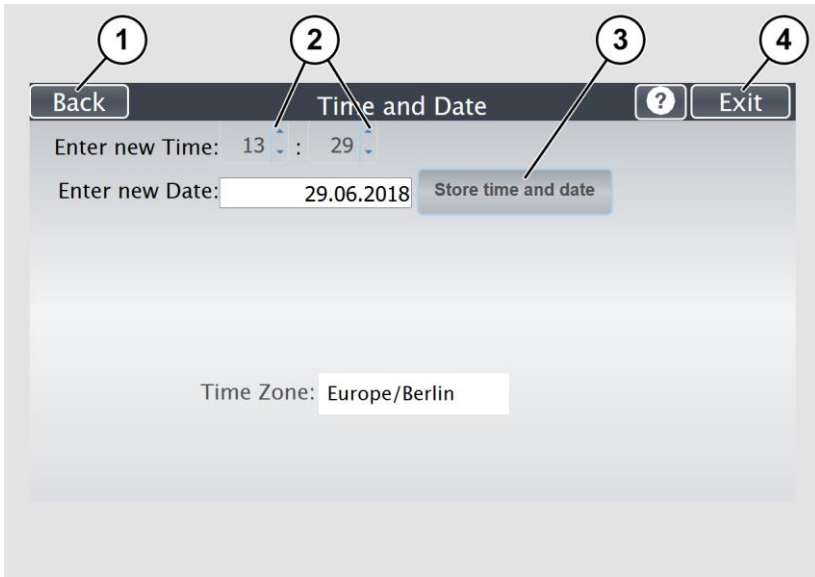

The "Start screen" is displayed.

To set the date, proceed as follows:

➤ Tap the "Enter new date" field.

A calendar (3) is displayed.

- Select the appropriate date in the calendar (3).
- To set the month and year, tap the arrow keys (2, 4) at the top of the calendar.
- To set the day, tap the corresponding day in the calendar.
- To save the date, click STORE TIME AND DATE (5).
- To return to the previous submenu, tap BACK (1).
- To return to the "Start screen", tap EXIT (6).

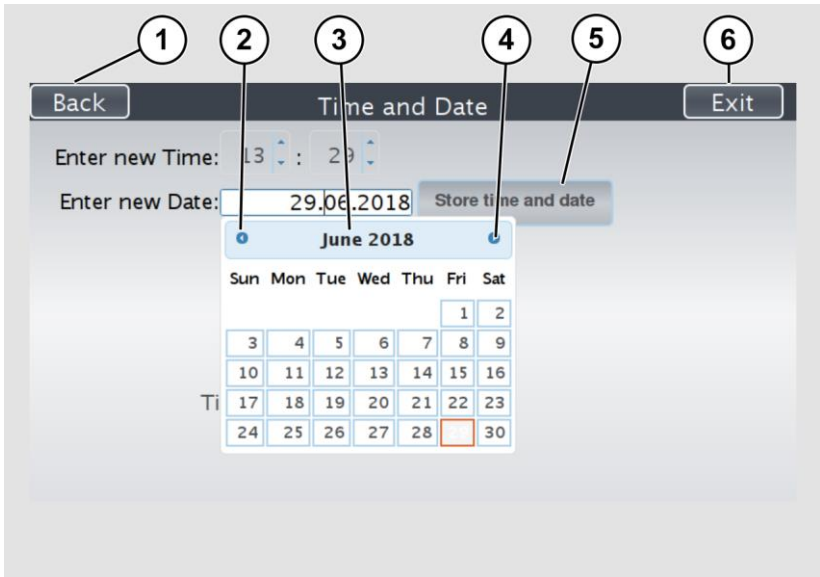

Perform Setup

- To select the time zone, tap the selection arrow (4).
A selection list with available time zones is displayed.
- Select the appropriate time zone.
- To save the time zone, click STORE TIME AND DATE (2).
- To return to the previous submenu, tap BACK (1).
- To return to the "Start screen", tap EXIT (3).

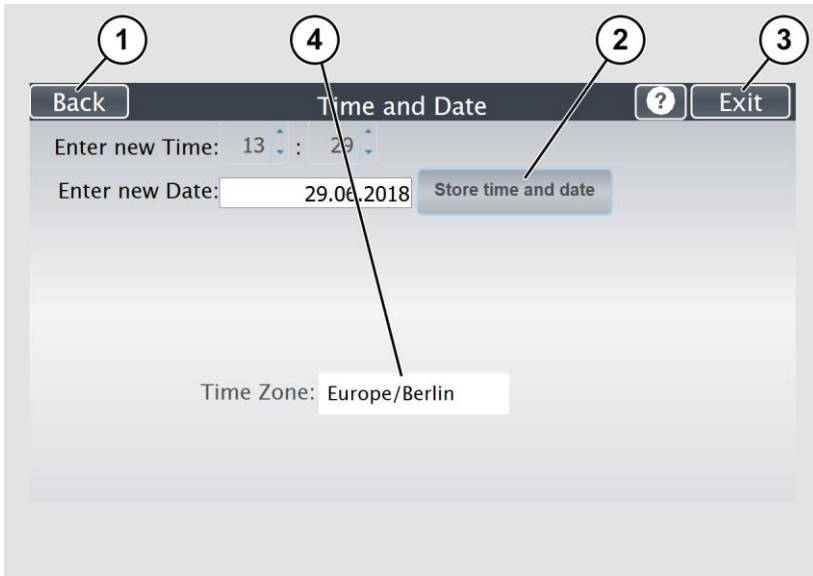

Perform Test Suite

- On the "Setup Menu" screen, tap on TESTSUITE (1).

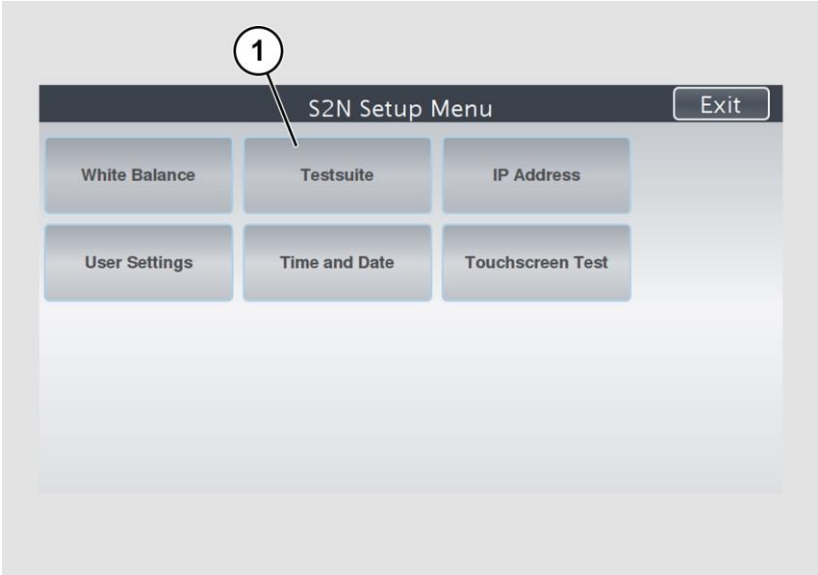

The "Testsuite" screen is displayed.

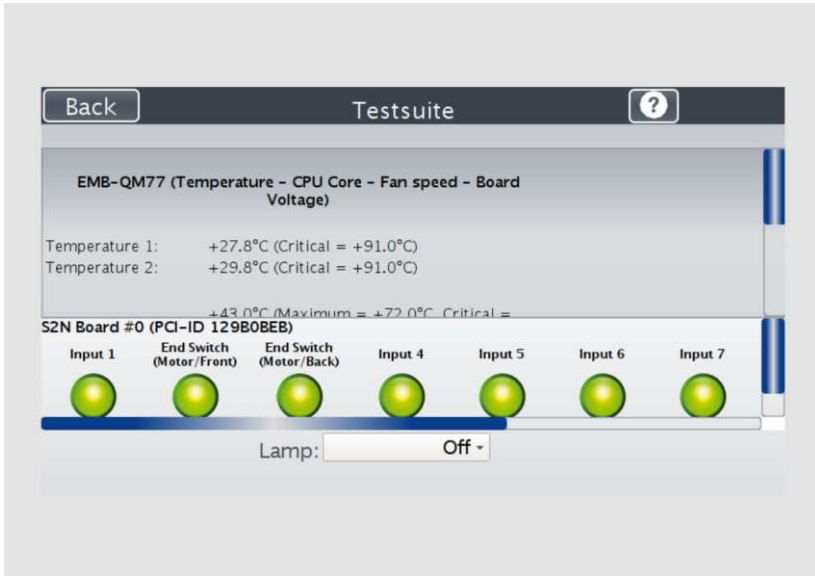

Information about the mainboard:

Display the current values for: Temperature of PCB and CPU cores, fan speed, PCB voltages

Information about the inputs:

Inputs will always appear green

Information on end position switches, foot switch and power button:

When the end position switches or the foot switch is pressed, the display changes from green to red, for as long as the switch or the button is pressed

Information about LED lamps:

Check function: Lamp off, on, top, bottom, default

Test the LED Lamps Functionality

- To check whether the LED lamps work properly, select from the "Lamp" menu the entry "Lamp On" (3).

The LED lamps are illuminated.

- To return to the previous submenu, tap BACK (1).
- To return to the "Start screen", tap EXIT (2).

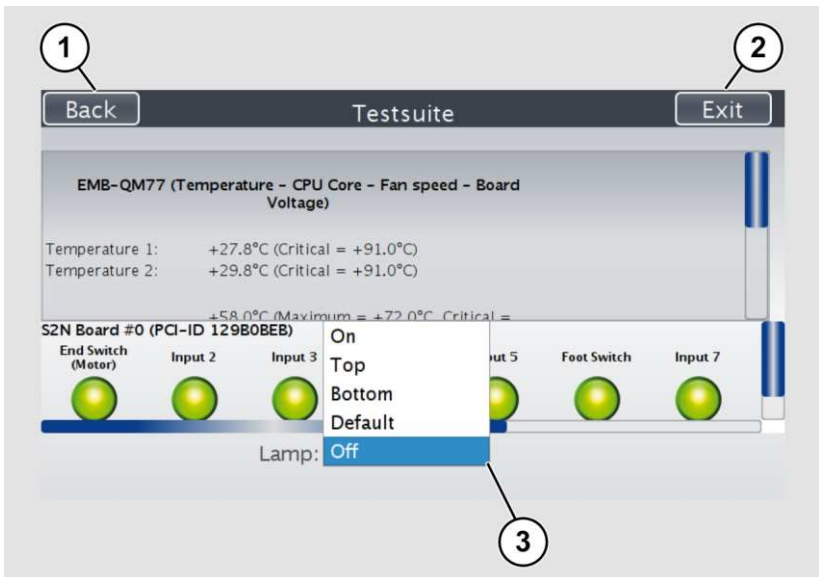

Test the Optional Foot Switch Functionality

- To check whether the actuation of the foot switch is detected by the system, press down the connected foot switch.

The field "Foot Switch" (3) is shown in red. Pressing the foot switch is detected by the system.

- To return to the previous submenu, tap BACK (1).
- To return to the "Start screen", tap EXIT (2).

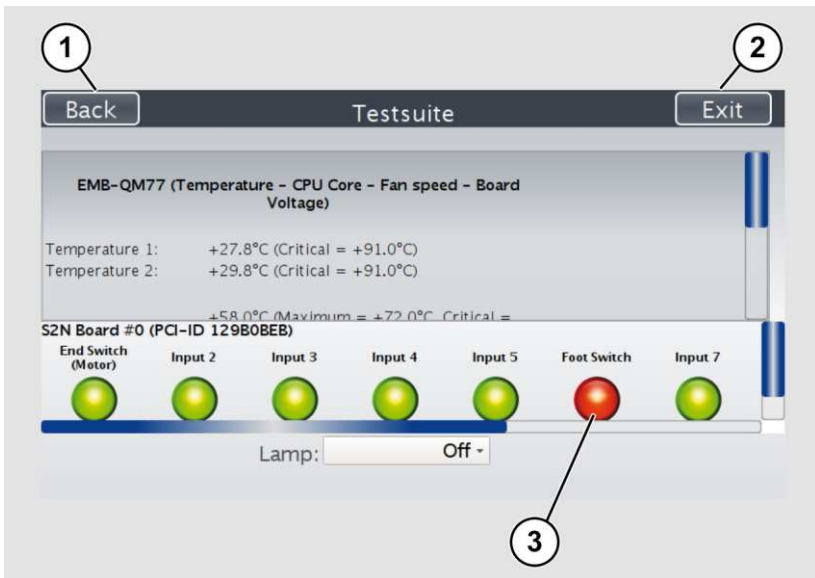

Perform Touchscreen Test

To check the functionality of the touchscreen when touched, proceed as follows:

- On the "Setup Menu" screen tap the TOUCHSCREEN TEST (1) button.

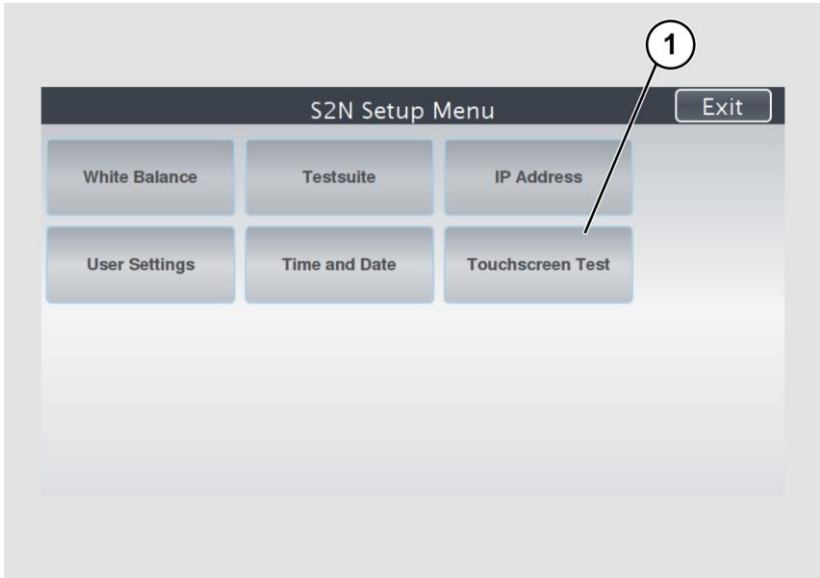

The "Touchscreen Test" screen is displayed.

- To perform the "Touchscreen Test" tap with your finger on the corresponding screen (3).

The crosshairs must occupy the same position as the finger.

- To end the "Touchscreen Test", tap the STOP TOUCHSCREEN TEST (1) button.

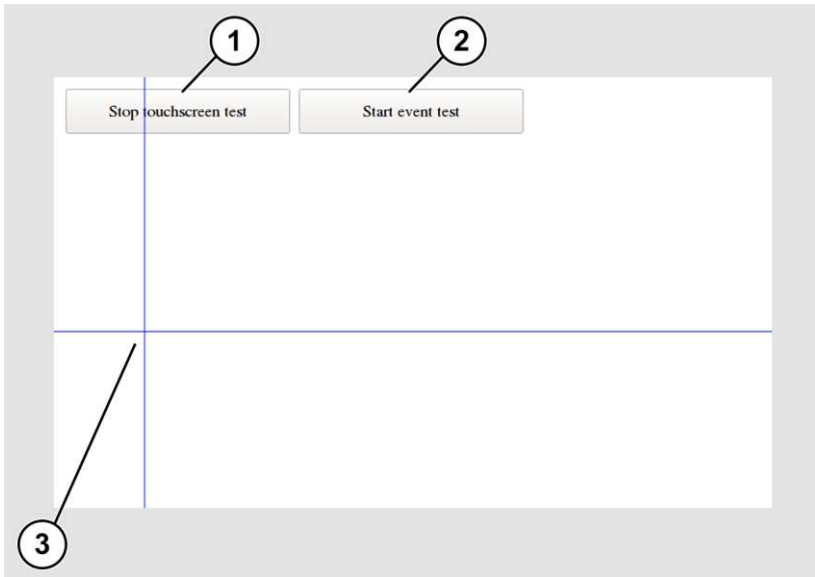

- Tap the START EVENT TEST (2) button.

The "Event Test" screen is displayed.

The X button (3) cancels the test and returns to the start screen "Touchscreen Test".



- Hold the upper left blinking green rectangle (1) with your finger.
- Swipe your finger from top left to top right over the touchscreen.

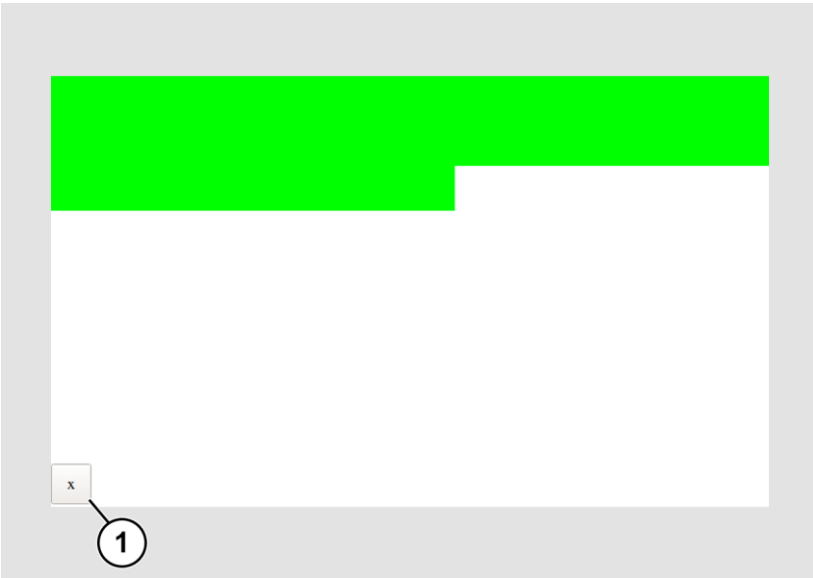

Green rectangles are drawn step by step.

These rectangles mark the area where the "Event Test" has detected the motion events.

- As soon as you arrive at the top right, move down one line and then move to the left again.
- Continue with this procedure until you have reached the lower right edge of the screen.

This test can be aborted at any time by pressing the X (1) button.

If the entire screen is green, the test ends automatically.

The start screen of the "Touchscreen Test" appears.

The "Start screen" is displayed.

Recovery

Hard Disk / Solid State Disk Software Failure

The file system and the Linux operating system of a Scan2Net scanner are very robust and forgiving. The file system has the ability to repair itself, even if the system loses power during a disk write operation, a condition which will almost certainly corrupt any Windows, Android or MAC OS based computer.

Nevertheless, under certain circumstances it could happen that the Scan2Net Linux software on the HD/SSD becomes corrupt. Unexpected power failures, hard power off cycles via the main power switch without a previously controlled shut down and other unexpected terminations of the operating system may cause this kind type of failure. Also, any uncontrolled interrupt of a firmware update procedure or other functions which involve writing to the main storage (HD or SSD) are a potential risk to the integrity of the firmware on the HD/SSD. The Scan2Net operating system of every WideTEK® or Bookeye® scanner is Linux based and although it happens very rarely, the Linux operating system can be corrupted like any other operating system; whether it is a Windows, Android, Mac or any other OS.

If the Linux operating system or other parts of the HD/SSD are corrupted, there is still no need to replace the HD/SSD, at least not before the recovery procedure is executed once. This procedure is similar to the procedures necessary to restore a Windows, Android or Apple OS to a previous state.

Recover the HD/SSD to Factory Default

In a Scan2Net® scanner, an image of the Scan2Net Linux operating system is stored on the Recovery Partition at certain times. The image is generated at the time of manufacturing, and also any time an HD/SSD needed to be replaced.

Preparations to Recover an HD/SSD



- Make sure that you know the scanner's IP address, subnet and gateway valid for the network or have the network administrator available.
- Login to the Image Access Customer Service Portal at <http://portal.imageaccess.de> and obtain the latest firmware for your device.

Step	Action
1	If still possible, shut down the scanner, either through the touch panel or through the currently used application or by pushing the start button on the scanner's housing. Otherwise, switch off the scanner at its main power switch.

Recovery Process



Make sure that the following process is not interrupted by a hard shut down or power failures.

If this process is interrupted, a loss of the recovery partition is possible, making it mandatory to physically replace the HD/SSD.





The following process cannot be influenced by the user.

Recovery Process 1

The recovery procedure is a simple multistage process.

Step	Action
2.1 - Scanner with recovery key	Wait until the scanner has powered down, then plug in the recovery key to the DB9 connector on the rear side of the scanner.
2.2 - Scanner with STOP button	Wait until the scanner has powered down.
3 - All scanners	Make sure that the main power is switched on.
4.1- Scanners with recovery key	Power up the scanner via the POWER button.
4.2 - Scanners with STOP button	<p>Press and hold the red STOP button (1) before switching ON.</p> <p>Power up the scanner via the POWER button.</p> <p>Important: The red STOP button (1) must be pressed and then held until the red button is lit permanently.</p>

Step	Action
5 - All scanners	<p>The recovery procedure starts automatically.</p> <p>It replaces the corrupted content of the Scan2Net Linux partition with the content of the recovery partition.</p> <p>This process takes about 10 - 15 minutes.</p> <p>At the end, it powers down the scanner.</p>
6 - All scanners	Wait until the scanner has powered down.
7 - All scanners	Switch it off via the main power switch.
8 - Scanners with recovery key	Remove the recovery key from the connector on the rear side of the scanner.
9 - All scanners	Switch on the scanner via its main power switch.
10 - All scanners	Power up the scanner via the start button.

-  After this procedure is complete, all network credentials are lost. Important: The default IP address is now reset to the factory default 192.168.1.50!
-  To set up your own network configuration, please refer to the chapter Assign the IP Address in this Setup and Instructions manual.

Recovery Process 2 - Update Scanner Firmware

Step	Action
11	In case the currently installed firmware of the scanner is not the latest version, connect the scanner via a web browser.
12	Select "Setup Device".
13	Login in as "Poweruser" with the user name "Poweruser" and the corresponding password. Default password is "Poweruser".
14	Select "Updates & Uploads".
15	In the section "Update Scanner Firmware", update the scanner with the firmware version you downloaded from the Customer Service Portal.

Recovery Process 3 - Adjustments

Finally, it is required to perform a few adjustments.

 Note: All scanners require that you at least adjust the White Balance.

- Please refer to the Perform Setup chapter in the Setup & Instructions manual of your scanner for the necessity of further adjustments.

End of recovery process.

Maintenance

-  Ensure that no liquids penetrate the device housing.

Touchscreen

The touchscreen can be cleaned with a microfiber cloth.

Before cleaning the touchscreen, switch the scanner off and set the main power switch to position 0.

Surfaces

Use a soft, dampened cloth to clean the housing of the scanner. Recommended is a micro fiber cloth.

Cleaning the Glass Plate

It is recommended to clean the glass plate periodically to ensure constant good scan results.

To clean the glass plate, lift up the glass cover.

Use the microfiber cloth which is delivered with the scanner or a fluff-free cloth.

- ① Because of the coating of the glass plate always use only a few drops of a mild cleaning fluid with the microfiber cloth.
Wet the microfiber cloth, then apply a few drops of a mild cleaning fluid and clean the glass plate without pressing the cloth on it .
Use a soft cotton cloth to dry the glass plate after cleaning.

Repair

- ① There are not any parts or components of the WideTEK® scanner which can be repaired by the user.
All repairs and service works should be done by a trained technician only.

Technical Specifications

WideTEK® 12 Scanner Specifications

Optical system

Maximum document size	317 × 470 mm / 12.5 x 18.5 in
Scanner resolution	1200 × 1200 dpi
Optical resolution	1200 × 600 dpi
Pixel size	9.3 + 9.3 μm
Sensor type	Tri-color line sensor CCD
Color depth	16-bit grayscale (internal resolution) 48-bit color (internal resolution)
Sensor resolution	22.500 pixels
Scan modes	24-bit color, 8-bit color indexed 8-bit grayscale, bitonal, halftone
File formats	Multipage PDF (PDF/A) and TIFF, JPEG, JPEG 2000, PNM, PNG, BMP TIFF (Raw, G3, G4, LZW, JPEG), AutoCAD DWF, JBIG, DjVu, DICOM PCX, Postscript, EPS, Raw data
Scan accuracy	Better than ± 0.1% over max. scan area

Illumination

Light source	Two lamps with white LEDs, integrated optical diffusor
Intensity	3000 lux maximum
Temperature induced change	None
UV / IR radiation	None
Lifetime of the LEDs	50.000 hours (typically)

Glass Plate

Maximum permissible document weight	10 kg / 22 lb.
-------------------------------------	----------------

WideTEK® 25 Scanner Specifications

Optical system

Maximum document size	635 × 470 mm / 25 x 18.5 in
Scanner resolution	1200 × 1200 dpi
Optical resolution	1200 × 600 dpi
Pixel size	9.3 + 9.3 μm
Sensor type	2 x Tri-color line sensor CCDs
Color depth	16-bit grayscale (internal resolution) 48-bit color (internal resolution)
Sensor resolution	45.000 Pixel (2 × 22.500)
Scan modes	24-bit color, 8-bit color indexed 8-bit grayscale, bitonal, halftone
File formats	Multipage PDF (PDF/A) and TIFF, JPEG, JPEG 2000, PNM, PNG, BMP TIFF (Raw, G3, G4, LZW, JPEG), AutoCAD DWF, JBIG, DjVu, DICOM PCX, Postscript, EPS, Raw data
Scan accuracy	Better than ± 0.1% over max. scan area

Illumination

Light source	Two lamps with white LEDs, integrated optical diffusor
Intensity	3000 lux maximum
Temperature induced change	None
UV / IR radiation	None
Lifetime of the LEDs	50.000 hours (typically)

Glass Plate

Maximum permissible document weight	10 kg / 22 lb.
-------------------------------------	----------------

Ambient Conditions

Ambient temperature during operation	+5 to +40 °C
Storage temperature	0 to +60 °C
Relative humidity	20 to 80% (non-condensing)
WideTEK® 12 noise development	≤ 40 dB(A) (scanning) ≤ 25 dB(A) (standby)
WideTEK® 25 noise development	< 42 dB(A) (scanning) < 32 dB(A) (standby)

Electrical Specifications

External Power Supply

Input voltage	100–240 Vac
Frequency	47–63 Hz
Output voltage	24 Vdc
Output current	6,25 A
ECO Standard	CEC Level VI

Scanner

Input voltage	24 Vdc
Input current	Max. 5 A

Power Consumption WideTEK® 12

Sleep mode	≤ 0.5 W
Standby mode	2,5 W
Ready to scan	28 W
Scanning	55 W

Power Consumption WideTEK® 25

Sleep mode	≤ 0.5 W
Standby mode	4,8 W
Ready to scan	35 W
Scanning	72 W

Dimensions and Weight WideTEK® 12

Scanner (H × W × D)	222 × 440 × 795 mm 8.8 × 17.4 × 31.3 in
Weight	28 kg / 62 lb.
Transport box (H × W × D)	360 × 520 × 900 mm 14.2 × 20.5 × 35.5 in
Weight, ready to ship	40 kg / 88 lb.

Dimensions and Weight WideTEK® 25

Scanner (H × W × D)	225 × 760 × 795 mm 8.9 × 29.9 × 31.3 in
Weight	44 kg / 97 lb.
Transport box (H × W × D)	450 × 1200 × 1000 mm 17.7 × 47.2 × 39.4 in
Weight, ready to ship	78 kg / 172 lb.

End of document

