

# SCANTECH ID

Installation & User's Manual

Scantech ID **LIBRA L-7050**

**Multi-purpose  
Omni-directional Scanner**





# **Installation & User's Manual**

---

**Scantech-ID LIBRA L-7050**  
**Multi-purpose Omni-directional scanner**

## **Copyright © 2010, Scantech-ID BV.**

This manual is copyrighted, with all rights reserved. Under the copyright laws, this manual may not, in whole or in part, be copied, photocopied, reproduced, translated or converted to any electronic medium or machine readable form without prior written consent of Scantech-ID BV.

### **Limited Warranty**

Under all circumstances this manual should be read attentively, before installing and/or using the product. In no event shall Scantech-ID BV be liable for any direct, indirect, special, consequential or incidental damages arising out of the use or inability to use this documentation or product, even if advised of the possibility of such damages. In particular, Scantech-ID BV shall not be liable for any hardware, software, or data that is stored or used with the product, including the cost of repairing, replacing or recovering the above. Scantech-ID BV reserves the right to change parts of the device at any time without preceding or direct announcement to the client.

Scantech-ID BV reserves the right to revise this manual, and to make changes in the contents without obligation to notify any person or entity of the revision or change. A serial number appears on the product. Make sure that this official registration number has not been removed. It should be used whenever servicing by Scantech-ID BV or an authorized Scantech dealer is necessary.

### **Important**

This equipment has been tested and found to comply with the limits for a Class B digital device, pursuant to EN55022, and with the limits for a class A digital device, pursuant to part 15 of the FCC rules. These limits are designed to provide reasonable protection against harmful interference when the equipment is operated in a commercial environment. This equipment generates, uses, and can radiate radio frequency energy and, if not installed and used in accordance with the user's manual, may cause harmful interference to radio communications. Operation of the equipment in a residential area is likely to cause harmful interference in which case the user will be required to correct the interference at his own expense. Any unauthorized changes or modifications to this equipment could void the user's authority to operate this equipment.

#### *For CE-countries:*

- LIBRA is in conformity with the CE standards. Please note that a Scantech CE-marked power supply unit should be used to conform to these standards.

# Table of contents

---

Preface .....	1
<b>Chapter 1 Product Safety</b> .....	<b>3</b>
1.1 LASER SAFETY .....	4
1.2 DECLARATION OF CONFORMITY .....	5
<b>Chapter 2 Installation</b> .....	<b>7</b>
2.1 UNPACKING .....	8
2.2 CONNECTING .....	10
2.3 ADJUSTING .....	11
2.4 POWERING .....	12
2.5 INITIALIZING .....	13
<b>Chapter 3 Using LIBRA</b> .....	<b>15</b>
3.1 SCANNING BARCODES .....	16
3.2 CONTROLLING .....	17
3.3 MAINTAINING .....	17
<b>Chapter 4 Applications</b> .....	<b>18</b>
4.1 LIBRA AS A CORE MODULE OF YOUR APPLICATION SOLUTIONS	19
<b>APPENDICES</b> .....	<b>22</b>
A. CONNECTOR TYPES AND PIN DEFINITIONS .....	22
B. TECHNICAL SPECIFICATIONS .....	24
C. TROUBLESHOOTING .....	26



## Preface

Scantech ID LIBRA is a high performance, multi-interface, and omni-directional scanner. The unit comes with powerful reading sensitivity which allows hands-free bar code scanning. Bar code labels are read by presenting the label towards the scanner. Scanning labels with LIBRA hardly requires any arm movement.

LIBRA reads all popular bar code symbologies. An important feature of LIBRA is its auto-sense mode. If the scanner is not used within a programmable period of time, the scanner switches off automatically. The scanner can be reactivated by placing a barcode towards the window of the LIBRA.

LIBRA is designed with a specific size for all kinds of store applications and ideal to use in check out services.

## Features

### *Integrability*

The compact design allows the unit to be mounted with ease on a host system with minimum space requirement.

### *Quality and Durability*

- The components are of top quality and the case is solid, moist and dust resistant. All of these secure a long and service free operation time.
- Durable characteristic with IP42 rating and drop resistance.(with cable).
- Automatic sleep and wake-up mode which saves power and improves life time.

### *Flexibility and Connectivity*

The multiple connection interfaces (RS232, Keyboard Wedge, USB, and Powered USB) allow the unit to communicate with the host system with considerable flexibility.

### *Decoding Capability*

- The barcode decoding capability is up-to-date, including GS1 DataBar and all major 1D barcode symbologies.
- The Scantech-ID STAR reconstruction software enables the reading of fragmented and damaged barcodes.

## **About this manual**

This manual contains four chapters and three appendices:

- The first chapter provides the product safety information. The second chapter describes LIBRA's general features and installation. The third and fourth chapters account for the use of LIBRA.
- The connector types and pin definitions, technical specifications, and troubleshooting can be found in the appendices.



# **Chapter 1**

## **Product Safety**

## 1.1 LASER SAFETY

### **English:**

LIBRA scanner complies with safety standard IEC60825-1 (2001) for a Class I laser product. It also complies with U.S. 21CFR1040 as applicable to a Class IIa laser product. Avoid long term viewing of direct laser light.

### **Optical:**

The use of optical instruments with this product will increase eye hazard. Optical instruments include binoculars, microscopes and magnifying glasses but do not include eye glasses worn by the user.

### **Radiant Energy:**

LIBRA uses a low-power laser diode operating at 650 nm in an opto-mechanical scanner resulting in less than 0.6 mW peak output power. Laser light observed at 13 cm (5.1 in.) above the window through a 7 mm (0.28 in.) aperture and averaged over 1000 seconds is less than 3.9  $\mu$ W per CDRH Class IIa specification. Do not attempt to remove the protective housing of the scanner, as unscanned laser light with a peak output up to 0.8 mW could be accessible inside.

### **Laser Light Viewer:**

The scanner window is the only aperture through which laser light may be observed on this product. A failure of the scanner motor, while the laser diode continues to emit a laser beam, may cause emission levels to exceed those for safe operation. The scanner has safeguards to prevent this occurrence. If, however, a stationary laser beam is emitted, the failing scanner should be disconnected from its power source immediately.

### **Adjustments:**

Do not attempt any adjustments to or alteration of this product. Do not remove the scanner's protective housing. There are no user-serviceable parts inside.

### **WARNING!**

Use of controls or adjustments or performance of procedures other than those specified herein may result in hazardous laser light exposure.

## 1.2 DECLARATION OF CONFORMITY

### Scantech-ID B.V.

Scantech-ID BV  
Vanadiumweg 22  
3821PZ Amersfoort  
The Netherlands  
Tel. +31 (0)33 4698400  
Fax +31 (0)33 4650615

### Hereby declares under our sole responsibility that the product:

Product: LIBRA  
Model number: L-7050 (and equivalent)  
Product View:



### Will comply with the following product specifications:

Laser Safety:       - IEC60825-1  
                          - CFR 1040 Class IIa  
                          - CDRH

Electrical Safety:   - EN 60950-1: 2001

EMC:       - EN 55022:2006 + A1:2007  
              - EN 61000-3-1:2006  
              - EN 61000-3-3:1995 + A1:2001 + A2:2005  
              - EN 55024:1998 + A1:2001 + A2:2003

Please note that a Scantech ID CE-marked power supply unit should be used to confirm the product specifications stated above.

CE, FCC, BSMI and RoHs compliant

## SCANNER LABELING

The product label and the laser safety label are on the back and the side of LIBRA as indicated in the illustration below. All labels are attached by the manufacturer and should not be removed.

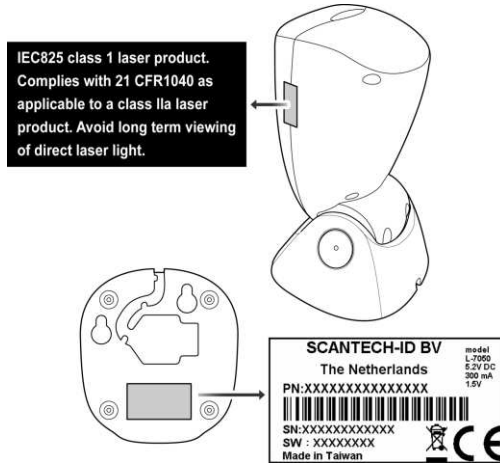

The information about the serial and part numbers can be found on the product label. These official registration numbers are strictly related to the device. The supplier may ask for these numbers when the scanner needs servicing.

## **Chapter 2**

### **Installation**

## 2.1 UNPACKING

Your package comes with the following items:



Item	Name
1	Scanning unit, packed by plastic bag
2	EPE packing foam
3	AC adapter set (for RS-232 model only)
4	Configuration Guide
5	Interface Cable

### NOTE

- If anything is missing or appears to be damaged, immediately contact your dealer.
- You can mount LIBRA without the fit plate, but the plate may be suitable for your special mounting requirements. Contact your dealer for more information.
- Store the original packaging box. Use it to transport LIBRA for future servicing.

## Exterior View

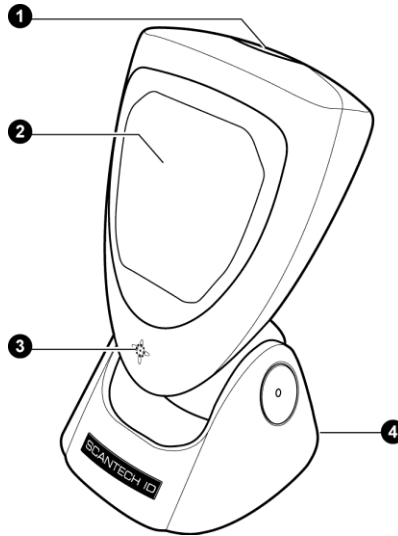

Item	Name	Description
1	LED	Lights to indicate the scanner status: <ul style="list-style-type: none"> <li>• Blue – Standby mode, ready to read</li> <li>• Orange – Successful read</li> </ul>
2	Window	Reads the bar code placed in front of the window.
3	Buzzer	Beeps when data is read correctly.
4	Cable hook	Use to align the cable.







### NOTE

LIBRA beeps whenever data is read correctly. Both frequency and volume can be adjusted (see section 2.1.1 Speaker frequency and 2.1.2 Speaker volume on the Configuration Guide).

## 2.2 CONNECTING

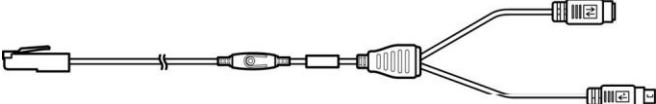
### Interface Selection

LIBRA allows you to connect your host system using four different interface cables: RS232, Keyboard Wedge, USB, and Powered USB. On powering up, the scanner determines the type of the interface used and switches to the appropriate protocol.

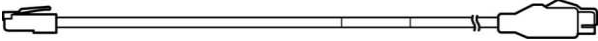
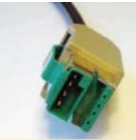
Interface Cable	Connector type
<b>RS232</b> (Product Number: 0114-SM01121)	Sub-D 9-pin
	
<b>Keyboard Wedge</b> (Product Number: 0114-SM02121)	Standard PS2
	
<b>USB</b> (Product Number: 0114-SM04121) USB Cable 1.5M (3M optional)	USB connector
	
<b>Powered USB</b> (Product Number: 0114-S801121)	Powered USB connector
	



### Changing the interface cables

By default, a USB cable is already attached to LIBRA upon receiving it. To change the interface connection, follow the steps below:

1. Hold the LIBRA upside down.
2. Remove the attached cable.
3. Connect the desired interface cable to LIBRA.

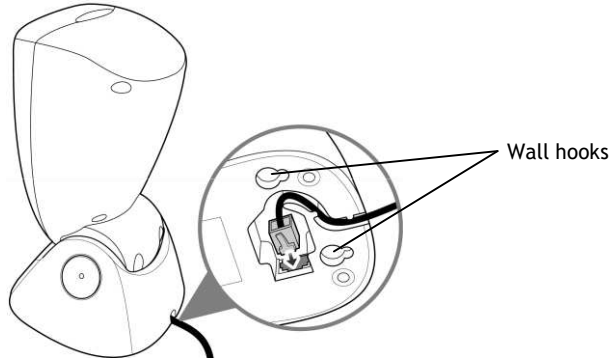

4. Align the cable through the cable hook.
5. Connect the other end of the interface cable to your host system.
6. If necessary, mount the scanner on the wall using the wall hooks.

## 2.3 ADJUSTING

LIBRA's angle can be adjusted. To do this, hold LIBRA by its back and adjust the angle as shown below.

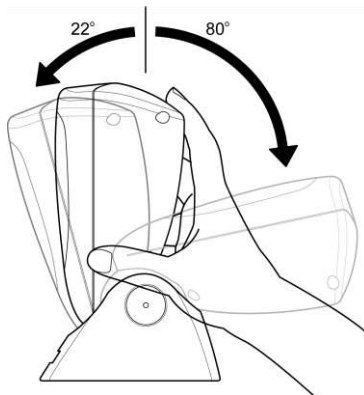

Front angle: 22° (max) / Back angle: 80° (max)

## 2.4 POWERING

LIBRA is designed to use a single cable for both data transmission and power supply. This requires that your host system can provide sufficient power on its data port (RS232, KBW, or USB).

### Power injector

Some applicable LIBRA interface cables have a power injector to connect an external power supply in case the host system cannot supply sufficient power for the scanner.

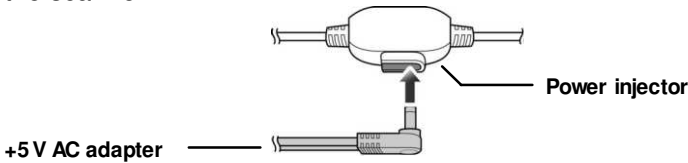

Cable	Power injector
RS232, Keyboard Wedge	√
Powered USB, USB	×

### NOTE

- Though some cables have a power injector, this does not mean that you must use a power supply.
- For safety reasons, an automatic switch will disconnect the power provided by the host system, as soon as a separate power adapter is connected to the power injector.

### Changeable power plugs

To change the power plug suited to your area, follow the steps below:

1. Press and hold the tab on the AC power adapter.
2. Remove the changeable plug outwards.

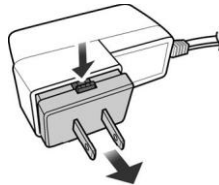

3. Replace with the desired power plug.

## 2.5 INITIALIZING

When using LIBRA for the first time, you need to initialize the communication parameters first. Follow the steps below to initialize:

1. Ensure that the desired interface cable is connected to LIBRA and your host system.
2. Power up LIBRA.
3. Initialize the communication parameters by scanning the programming barcode 1.1 and 1.3 on the Configuration Guide.

### NOTE

The procedure is required only once. However, when changing the cable from one type to another, you need to perform the procedure again.

### KBW mode

In KBW (Keyboard Wedge) mode, the scanner defaults to the International Keyboard layout (ALT-method) for communication.

### NOTE

To change the settings to national keyboards in KBW mode, refer to section 3.4 on the Configuration Guide.

### RS232 mode

In RS232 mode, the default communication parameters are 9600,N,8,2. Using the Scantech-ID Configuration Guide, you may select one of the various presets, or set each parameter by hand.

### USB mode

In USB mode, the scanner defaults to Keyboard Emulation Mode. LIBRA transmits the data in International Keyboard layout (ALT-method) for communication.

### NOTE

The LIBRA-USB must be directly connected to the host-USB port and not through an (un-powered) USB hub.

Other available USB communication selections are:

- USB IBM fixed POS scanner
- USB IBM handheld scanner emulation
- USB COM port emulation

**NOTE**

See section 3.5 USB communication on the Configuration Guide for more information.

# **Chapter 3**

**Using LIBRA**

### 3.1 SCANNING BARCODES

LIBRA is an omni-directional presentation scanner featuring a 6 directional scan field with a 24-line scan pattern. Barcode labels can easily be read by presenting them to the scanner.

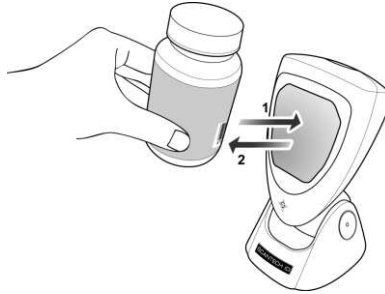

**NOTE**

Since LIBRA is a **presentation** scanner, best results are obtained if the barcode is moved **towards** the scanner.

LIBRA's scan volume is illustrated in the figure below. The scan depth varies depending on the size of the barcode.

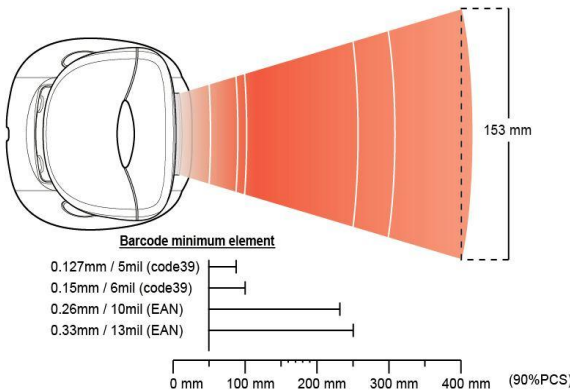

(Performance may be impacted by bar code quality and environmental conditions)

Resolution-	DOF-
0.127mm / 5mil (Code39)-	50 ~ 90mm / 1.96 ~ 3.54 inch-
0.15mm / 6mil (Code39)-	50 ~ 100mm / 1.96 ~ 3.93 inch-
0.26mm / 10mil (EAN)-	50 ~ 220mm / 1.96 ~ 8.66 inch-
0.33mm / 13mil (EAN)-	50 ~ 230mm / 1.96 ~ 9.06 inch-

## 3.2 CONTROLLING

LIBRA can be controlled from the POS/PC system via the RS232 interface or via USB while using comport emulation. Control is achieved by transmitting single byte commands to the scanner. The following commands are available:

ASCII code	Function	Byte is also called
05 Hex	Power-up re-initialization	ENQ or <Ctrl-E>
0E Hex	Enable (cancels disable)	Shift Out or <Ctrl-N>
0F Hex	Disable	Shift In or <Ctrl-O>
12 Hex	Sleep	DC2 or <Ctrl-R>
14 Hex	Wake (cancels sleep)	DC4 or <Ctrl-T>

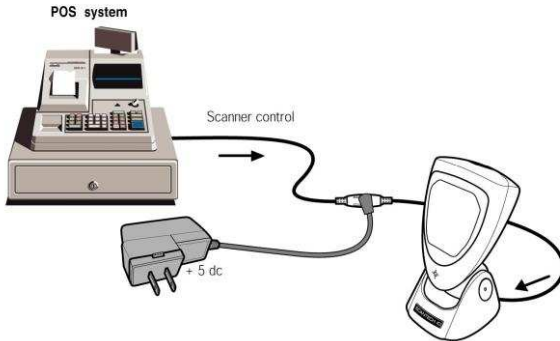

### NOTE

More commands are available upon request. Please contact your dealer for more information.

## 3.3 MAINTAINING

LIBRA requires little maintenance. Only occasional cleaning of the scanner window is necessary to remove dirt and fingerprints. Cleaning can be performed during operation with a non-abrasive glass spray cleaner and a soft lint-free cloth.

### NOTE

Please contact your dealer for specific cleaning material.

# **Chapter 4**

## **Applications**



## 4.1 LIBRA AS A CORE MODULE OF YOUR APPLICATION SOLUTIONS

Barcodes have become a distinguishing mark of modern civilization. The familiar stripes are popping up almost everywhere in everyday life: Libraries, retail stores, supermarkets, post offices, bill payment for services, law firms, shipping companies, enterprises, distributors, manufacturers, hospitals, etc.

The benefits of bar coding are obvious: improved data accuracy and accessibility enable a company to make correct decisions about future needs and actions. Consequently, profits are up.

### **Case: Benefits of Bar Coding for Retail Stores**

- Building a competitive infrastructure
- Synchronizing supply with demand
- Creating high profitability
- Trimming operational costs

## **Appendices**

- A. Connection Types and Pin Definitions
- B. Technical Specifications
- C. Troubleshooting



## A. CONNECTOR TYPES AND PIN DEFINITIONS

LIBRA supports multiple interface: RS232, KBW (Keyboard Wedge), USB, and Powered USB. The various pin definitions for each type of interface are given below.

### IMPORTANT

Various interface cables are available depending on the kind of host system you are using. Contact your supplier for availability. In case you need a special purpose cable, you can refer to the information below.

**The Connector type of LIBRA:** RJ-48, 10 pins.

### Pin Definition for multiple interface

Pin	Multiple Interface			
	RS-232	KBW	USB or Powered USB	
Pin	Description	Description	Description	Remark
1	-	-	IFID	IFID=Interface ID
2	CTS	PC-Clock	-	
3	RxD	PC-Data	-	
4	TxD	KB-Data		IFID=Interface ID
5	RTS	KB-Clock	-	
6	Ground	Ground	Ground	Ground
7	+5V	+5V	+5V	5V, may be used to power scanner *
8	D-Power	D-Power	D-Power	8-16V DC input to power scanner *
9	-	IFID: connect to '6'	D +	IFID=Interface ID D + = USB
10	-		D -	D - = USB data

\*LIBRA only requires one single DC input.

**Pin definition EAS connector**

	ESA	
Pin	Description	Direction
1	(-)	-
2	(+)	-

You can pull the EAS rubber cap out (as shown below ), and can find the two Pins of the internal deactivation antenna, which can be connected to an external EAS control unit.



**EAS wired  
rubber cap**

## B. TECHNICAL SPECIFICATIONS

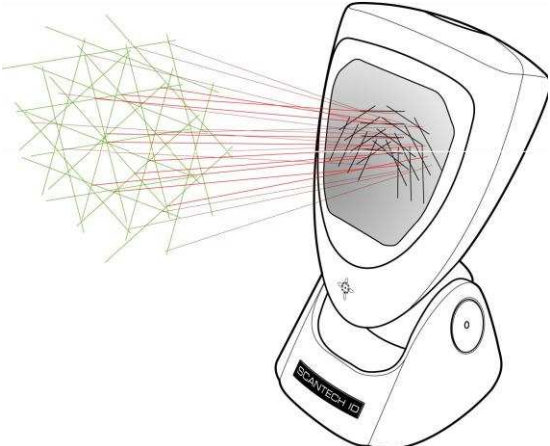
<b>Electrical</b>	
DC input to scanner	+5 V DC, 250 mA
Power output	1.7 Watt@ +5 V DC
Operating Power	DC +5 V, 340mA (typical)
Standby Power	DC +5 V, 270mA (typical)
<b>Scanner Characteristics</b>	
Light source	650 nm visible laser diode
Depth of field	Up to 230 mm@0.33mm/13mil, PCS 90% Code39
Resolution	4mil/0.1mm, PCS 30%
Scan pattern	6 direction scan field, 24 lines scan pattern
Scan rate	2,000 scans per second
Light level	Up to 4,800 LUX
EAS	EAS compatible (standard)
Barcode types	Automatically discriminates standard 1D bar codes include GS1 Databar family, Omnidirectional, Omnidirectional stacked, Expanded, Expanded stacked ,Truncated and Limited.
<b>Scan pattern @ 10 cm</b>	
	

**Physical Characteristics**

Depth	97.71 mm / 3.84 inches
Width	85 mm / 3.35 inches (scanner), 94 mm / 3.70 inches (base)
Height	161.51 mm / 6.36 inches
Weight	350g / 12.355oz
Color available	Black(Scanner+Base) or Beige(scanner) + Dark Grey(base)

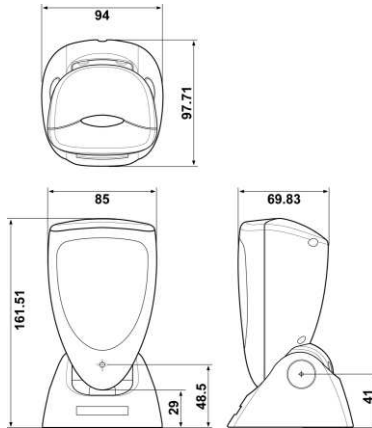
**Environmental**

Operating Temperature	0°C ~ 40°C
Storage Temperature	-20°C ~ 60°C
Humidity	5% ~ 95% RH (non-condensing dew)

**Safety**

Laser Safety	Class I: IEC60825-1, U.S. 21CFR1040 Class IIa
Electrical Safety	EN 60950-1: 2001

**EM Compatibility**

Radio and TV Interference	EN 55024/22, FCC Part 15 class B, CNS 13438
Electro Static Discharge	IEC 801-2 (1991) (ESD)

## C. TROUBLESHOOTING

This section contains information on solving problems you may encounter when using the scanner. If troubles occur, take a moment to read the information in this section. However, before referring to the diagnostic tips ensure that the scanner is installed as described in Chapter 2 and that all cables are properly connected.

Problem	Diagnostic Tips
The scanner is on but a barcode cannot be read.	<ul style="list-style-type: none"> <li>• The scanner window is dirty. Clean the scanner window as described in section 3.3.</li> <li>• The presented barcode type is not enabled. Select the barcode type with the Configuration Guide.</li> <li>• The scanner is disabled by the host. Refer to section 3.2.</li> <li>• The barcode type you presented to the scanner is not supported by LIBRA.</li> </ul>
The scanner does not accept more than two or three barcodes.	<ul style="list-style-type: none"> <li>• There is no proper handshaking with the host system. Switch the host system on and check connection and communication settings.</li> </ul>
A barcode is read by the scanner but not accepted by the host system.	<ul style="list-style-type: none"> <li>• The communication cable is not connected to the serial port of your host system. Refer to the manual of your host system to locate the serial port.</li> <li>• The communication settings of the host and scanner do not match. Ensure that the setting values for both devices are the same. For proper adjustment values, refer to the Configuration Guide.</li> <li>• The communication cable does not suit your host system. Contact your supplier for the correct communication cable.</li> </ul>



	<ul style="list-style-type: none"><li>• The data format is not supported by the software running on the host system.</li></ul>
USB communication is not working.	<ul style="list-style-type: none"><li>• In case of KB emulation you can select various 'keyboard languages' or the universal 'Alt-input-method' (default). You may want to try programming barcodes from section 3.4 on the Configuration Guide.</li><li>• In case of KB emulation in combination with the Alt-input method, check that Num-Lock of your keyboard is on.</li><li>• In MS-windows environment, verify with the device manager that the HID (Human Interface Device) is installed for the scanner.</li><li>• Check that the scanner and the host system both expect the same USB protocol (KB emulation, RS232 emulation or IBM POS protocol). See the Configuration Guide for setup codes and reset the scanner after making any changes. When using a standard-USB cable, the scanner defaults to the USB KB emulation protocol with ALT-method character transmission. When using USB plus power cable (with the green connector), the scanner defaults to USB-IBM-POS protocol for tabletop scanners. These settings are restored after programming "back to default" using the Configuration Guide.</li></ul>

Due to Champtek's / Scantech ID's continuing product improvement programs, specifications and features are subject to change without notice.



The top half of the page is decorated with several thin, red, parallel lines that are slightly curved and intersect, creating a dynamic, abstract pattern.

# SCANTECH ID

a Champtek company

Scantech-ID BV  
Vanadiumweg 22  
3812 PZ Amersfoort  
The Netherlands

Phone: +31(0)33 469 84 00  
Fax: +31(0)33 465 06 15  
Email: [info@scantech-id.com](mailto:info@scantech-id.com)  
Internet: [www.scantech-id.com](http://www.scantech-id.com)  
Internet: [www.champtek.com](http://www.champtek.com)