

UNPACKING

- ☉ Vybalení
- ☉ Auspacken
- ☉ Desembalaje
- ☉ Pakkauksen purkaminen
- ☉ Déballage
- ☉ Αποσκευασία
- ☉ Disimballaggio
- ☉ 開梱(内容物の確認)
- ☉ 개봉
- ☉ Uitpakken
- ☉ ROZPAKOWANIE
- ☉ Desempacotar
- ☉ Распаковка
- ☉ 打开包装
- ☉ 打開包裝
- ☉ KUTUNUN İÇİNDEKİLER

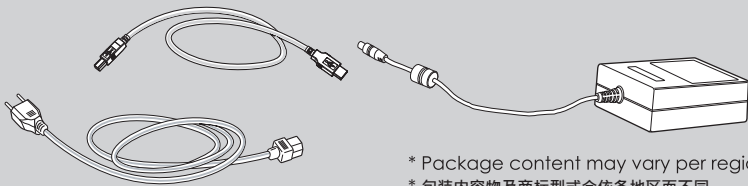
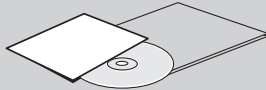
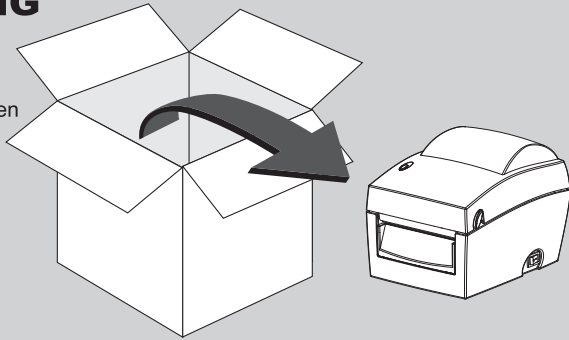

* Package content may vary per region.
* 包装内容及商标型式会依各地区而不同

CONNECTING

- ☉ Připojení
- ☉ Anschließen
- ☉ Conexiones
- ☉ Tulostimen liittäminen
- ☉ Branchement
- ☉ Σύνδεση
- ☉ Connessione
- ☉ 接続
- ☉ 연결
- ☉ Aansluiten
- ☉ PODŁĄCZENIE
- ☉ Ligações
- ☉ Соединение
- ☉ 连结
- ☉ 連結
- ☉ BAĞLANTI ŞEKİLLERİ

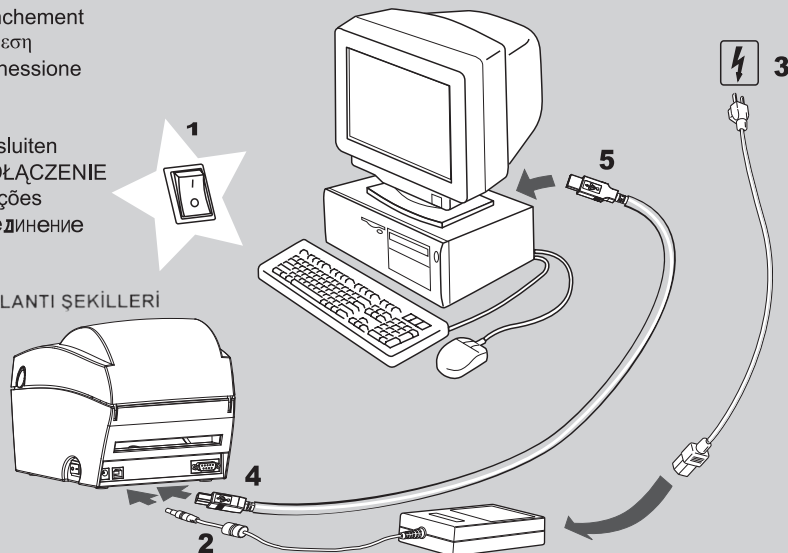

Quick Guide DT Series



GoDEX



GoDEX科诚官方公众号



视频网盘
电脑请登录
<http://i.youku.com/godexprinter>

PAPER LOAD

- ② Zloženi etiket
- ③ Carga de las etiquetas
- ④ Etiketmaterial einlegen
- ⑤ Tarrarullian aasennus
- ⑥ Φόρτωση ετικετών
- ⑦ 用紙の取付け
- ⑧ Instalazione Carta
- ⑨ 라벨 장착
- ⑩ Papir laden
- ⑪ Colocação de papel
- ⑫ ZAKLADANIE ETYKIET
- ⑬ 紙的安裝
- ⑭ Ycranovka etiket
- ⑮ ETIKET BESLEMMESI
- ⑯ 紙的安裝

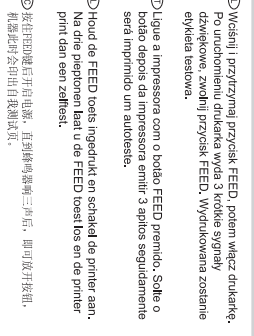
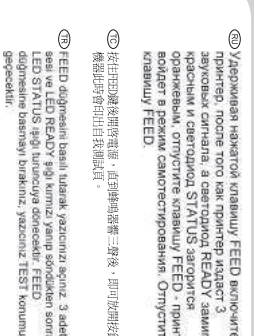
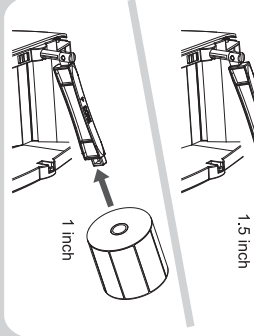
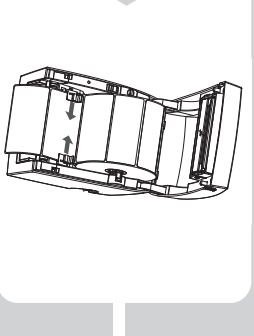
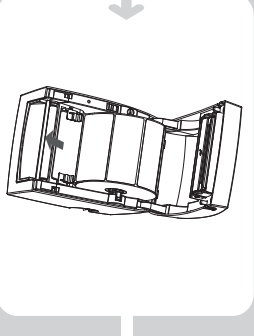
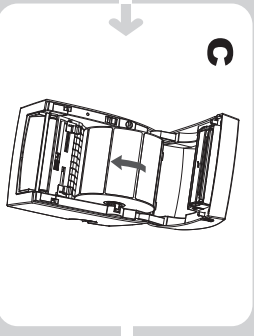
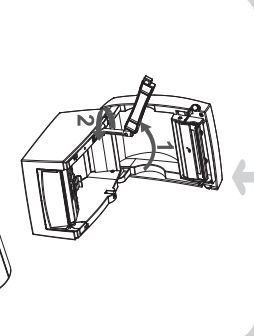
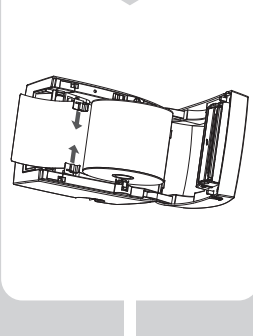
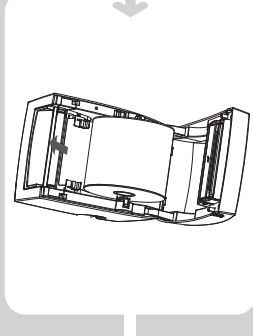
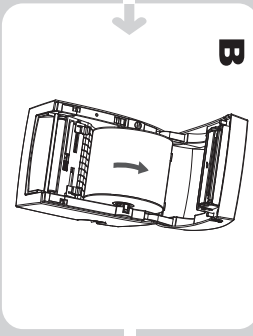
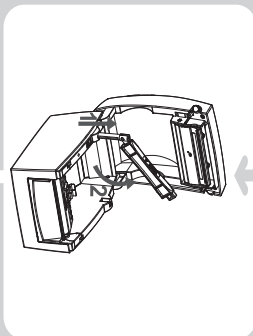
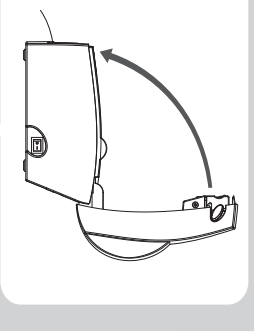
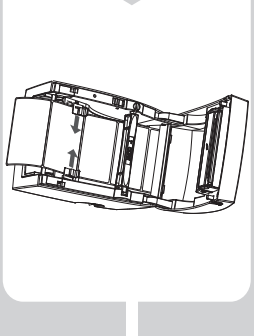
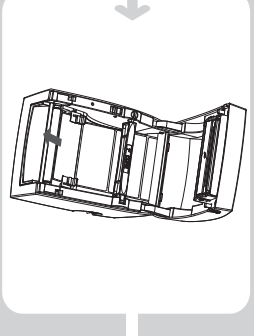
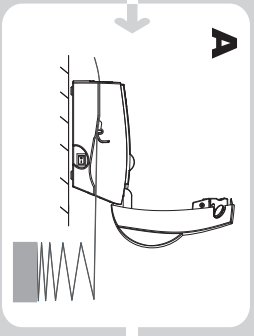
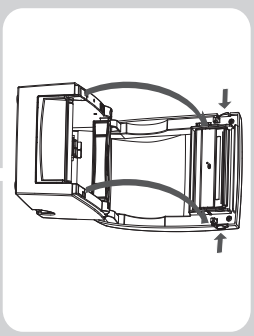

Press and hold the FEED button then power on the printer. After the printer is powered on, release the FEED button and a Self-test label will print.

② Štácke a držte tlačítko FEED a zapněte tiskárnu. Jakmile získáte 3krát pípnou, uvolněte tlačítko FEED a získáte výstiskné testovací etiketu.

③ Drücken und halten sie den FEED Knopf und schalten Sie den drucker ein. Nachdem der Drucker 3 mal piepst lassen Sie den Knopf wieder los und ein Selbsttest wird ausgedruckt.

④ Encienda la impresora con el botón FEED pulsado. Suelte el botón después de que la impresora emita 3 pitidos y a continuación se imprimirá un auto-test.

⑤ Pida FEED «apipinla painimena ja käynnistä tulostin. Vapauta näppäin kun tulostin on alkanut kolme äänimerkkiä. Tulostin tekee testitarin.

⑥ Appuyez et tenez le bouton de FEED et de 'ON' de l'imprimante. Après l'imprimante Beeps 3 fois, libérez le bouton de FEED et une étiquette d'essai de soi imprimera.

⑦ Идате на кнопуфер: натиснете го држтекно FEED кога тврда кодотра: кога издатра: Аспиот асакотра: 3 бепс: као сов асакотра: аспире го држтекно FEED кога во држе: издатра: јуж: Бексакотра: држтекно.

⑧ Per il Self Test, accendere la stampante tenendo premuto il tasto FEED. Dopo 3 beep rilasciare il tasto.

⑨ FEED ボタンを押し続け電源ボタンを押し続け、プリンタが3回「ピー」を鳴らしたら、FEED ボタンを離すと、自己診断ラベルが印刷されます。

⑩ FEED 버튼을 누른 상태에서 프린터의 전원을 켜주세요. 프린터가 3번 비프를 낸 후, FEED 버튼을 손을 떼주세요. 3회 울리는 비프를 들었을 때 라벨이 인쇄됩니다.

⑫ Уверкована навакторк: клавишу FEED вклучите притиснете, после тога как притиснете клавишу FEED, принтерот ќе издаде три бипови. Пошто ќе добиете три бипови, ослободете клавишу FEED и принтерот ќе исприне етикетка за самопроверка на работата на принтерот. Отпуснете клавишу FEED.

⑬ 按住了印機開機按鍵，直到聽到響三聲後，即可放開按鍵。機器的印機開機按鍵。

⑭ FEED dugmansi basani tutarak, yazdırıcıya sonra 3 adet bip sesi ve LED READY ışığı kimizi yazıp ardından sonra LED STATUS ışığı buruncuya dönene kadar FEED düğmesini basmayı bırakınız, yazdırıcınız TEST konumuna geçecektir.

⑮ Укљониј притиснутом притиску FEED, проблем везиц држтекне. По урочномому држтекне выдја 3 кодике сыгналы држтекнево, здохни притиску FEED. Выдтукнована зохстане етикетка тестовика.

⑯ Ulice a impresora con o botao FEED premido. Solté o botao depois da impressora emitir 3 apitos seguidamente seirá imprimido um autoteste.

⑰ Hold de FEED teats ingeridiki en schatel de printer aan. Na drie piepsonten u de FEED toest los en de printer print dan een zelftest.

